

The background of the entire page is a light gray circuit board pattern with various electronic components like resistors, capacitors, and integrated circuits. A dark blue horizontal band is positioned across the middle of the page, containing the main text.

COMMERCIAL LIGHTING CONTROLS

Title 24 2022

Design to meet code compliance with Lutron

USD List prices effective July 10, 2022

Table of Contents

Title 24 2022

Introduction

Solutions Overview	2
Summary of Code Requirements	4
Daylight Zone Requirements	5
Suggested Code Compliant Solutions	6
How to Use this Guide	8
Vive Local Solutions Layout	10

Applications

Atrium

Retrofit (Switching)	12
New Construction (Dimming 0-10V)	14

Break Room

Retrofit (Switching)	16
New Construction (Dimming 0-10V)	18

Classroom

Retrofit (Switching)	20
New Construction (Dimming 0-10V)	22
Recommended (Fixture Control)	24

Conference Room

Retrofit (Switching)	26
New Construction (Dimming 0-10V)	28
Recommended (Fixture Control)	30

Egress Corridor

Retrofit (Switching)	32
New Construction (Dimming 0-10V)	34

Guestroom

New Construction and Retrofit	36
---	----

Open Office

Retrofit (Switching)	38
New Construction (Dimming 0-10V)	40
Recommended (Fixture Control)	42

Private Office

Retrofit (Switching)	44
New Construction (Dimming 0-10V)	46

Restaurant

New Construction and Retrofit	48
---	----

Restroom (Multi-Stall)

Retrofit (Switching)	50
New Construction (Dimming 0-10V)	52

Retail





New Construction and Retrofit	54
---	----

Egress Stairwell

New Construction (Fixture Control)	56
--	----

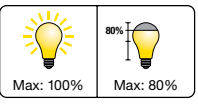
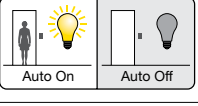
This document summarizes the lighting and receptacle control requirements for commercial buildings. It is for information purposes only. It is not meant to replace your state's or local jurisdiction's official energy code. Please refer to your local building energy code or Authority Having Jurisdiction (AHJ) for your precise requirements. Only the AHJ can guarantee code compliance.

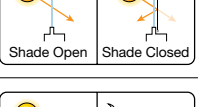
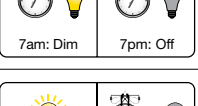
Energy-saving lighting control strategies

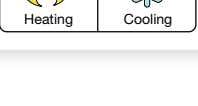
Strategy	Potential savings
 High-end trim/tuning sets the maximum light level based on customer requirements in each space.*	10–30% Lighting
 Occupancy/vacancy sensing turns lights on when occupants are in a space and off when they vacate the space.*	20–60% Lighting
 Daylight harvesting dims electric lights when daylight is available to light the space.*	25–60% Lighting
 Dimming control gives occupants the ability to set the light level.*	10–20% Lighting
 Controllable window shading moves shades to reduce glare and solar heat gain.*	10–20% Cooling
 Scheduling provides scheduled changes in light levels based on the time of day.*	10–20% Lighting
 Demand response automatically reduces lighting loads during peak electricity usage times.*	30–50% During peak period
 Plug load control automatically turns off loads after occupants leave a space.*	15–50% of Controlled loads
 HVAC integration controls heating, ventilation, and air conditioning systems through a contact closure.*	5–15% HVAC

*Go to lutron.com/references for more information.

Codes can sometimes be complicated and difficult to navigate. This commercial application guide provides examples of how Lutron products can be used to meet or exceed code requirements. This guide focuses on Vive and Vive compatible solutions, but our other control systems offer similar features.

Lutron Product Capabilities: Commercial Applications

Strategies for code/standards compliance	Local Solutions			Guestroom Solutions
	Wallbox	Vive wireless	Vive with wireless hub*	Code-compliant guestroom solutions
	Occupancy sensing	●	●	●
Multi-level lighting control	●	●	●	●
Daylight harvesting		●	●	
Receptacle control		●	●	●
Timeclock			●	●
Demand response			●**	
Energy monitoring			●	
BACnet integration			●	●

To learn more about these products and their specifications, go to lutron.com/catalogs.

* For the latest information on products compatible with the Vive wireless hub go to lutron.com/vive.

** Automated Demand Response capability requires signal from a third-party device.

Summary of Requirements for Lighting and Receptacle Controls

Title 24 2022

The requirements listed below are summarized for simplicity.

	Minimum control type	Description	Code provision
Local Control	Switching	Lighting shall be capable of turning ON and OFF. There shall be at least one manual device for control of the lighting within a space. See code for spaces that allow remote location of control.	130.1 (a)
	Multi-level or dimming ¹	Lighting shall be capable of multiple control steps in enclosed spaces 100 sq. ft. or larger. Light level requirements are defined in Table 130.1-A. There shall be at least one manual device for control of the lighting within a space. See code for spaces that allow remote location of control.	130.1 (b)
Automatic Control²	Timeclock ²	Interior: Scheduled control, based on time-of-day, turns lighting ON or OFF based on typical occupancy. Occupancy sensors also comply as an alternate to using a timeclock. Exterior: Scheduled control, based on time-of-day and sunrise/sunset (requires astronomical timeclock), turns lighting ON or OFF based on typical occupancy and daylight.	130.1 (c) 1 130.2 (c) 1, 2
	Occupancy sensor	Automatic control turns lighting ON upon occupancy or OFF after a vacancy of 20 minutes or less. When manual ON is used, provide a vacancy sensor which does not allow for automatic ON.	130.1 (c)
	Full ON	When initiated by a timeclock or occupancy sensor, lighting is automatically turned ON to maximum lighting power.	130.1 (c) 1
	Partial ON	When initiated by a timeclock or occupancy sensor, lighting is automatically turned ON to 50% to 70% of maximum lighting power.	130.1 (c) 5
	Full OFF	When initiated by a timeclock or occupancy sensor, lighting is automatically turned OFF.	130.1 (c) 5 130.2 (a)
	Partial OFF	When initiated by a timeclock or occupancy sensor, lighting is automatically reduced by at least 50% of maximum lighting power for interior spaces, 20% to 50% for parking garages. Exterior: Parking lot pole- and wall-mounted luminaires 24 ft. or less in height must be controlled with motion sensors that reduce lighting power by 50% to 90% or turn the lighting off when the zone is vacant by more than 15 minutes. Automatic full OFF also complies.	130.1 (c) 6 & 7 130.2 (c) 3
Other	Daylight responsive control ¹	Interior & Parking Garages: A sensor which adjusts lighting in response to available daylight is required for sidelight and skylight zones (see the "Daylight zone requirements" diagrams). Exterior: A photosensor can be used as an alternate to the dawn/dusk operation of an astronomical timeclock.	130.1 (d) 130.2 (c) 1
	Receptacle control	At least 50% of the receptacles shall automatically turn OFF based on typical occupancy or after a vacancy of 20 minutes or less. Each uncontrolled receptacle must have at least one controlled receptacle within 6 feet. Open offices with receptacles in modular furniture must include one controlled receptacle per workstation. Plug-in devices do not comply.	130.5 (d)
	Demand response	Buildings using more than 4000 watts of lighting power shall have demand-responsive lighting controls that reduce lighting power in response to an OpenAPR signal.	130.1 (e) 110.12 (c)

For areas being used as a path of egress or fixtures being used for emergency, verify compliance with your local AHJ. Acceptance (functional) testing is required for all new construction applications to ensure that control hardware and software are calibrated, programmed and functioning properly (Code provision C408.3).

- When multi-level lighting control and/or daylight responsive control is required, Lutron recommends using continuous dimming to allow for smooth light level adjustment and maximized energy savings.
- Lutron recommends using occupancy sensors to achieve automatic ON/OFF requirements in place of a timeclock to maximize energy savings and optimize user experience.
- Manual ON is always permitted for interior applications. Provide manual ON control when no automatic ON is indicated.

Daylight Zone Requirements

Title 24 2022

Daylight Zone Requirements:

Sidelighted daylight zones must be controlled separately from toplighted zones.

Daylight Exceptions:

Daylight control is not required when the total lighting power of a daylight zone is 120 W or less (60 W for parking garages), or when the total glazing/opening area is 24 sq. ft. or less (36 sq. ft. for parking garages). Other exceptions exist, based on space type, window area, neighboring obstructions, and glass transmittance.

Sidelighting (Window)

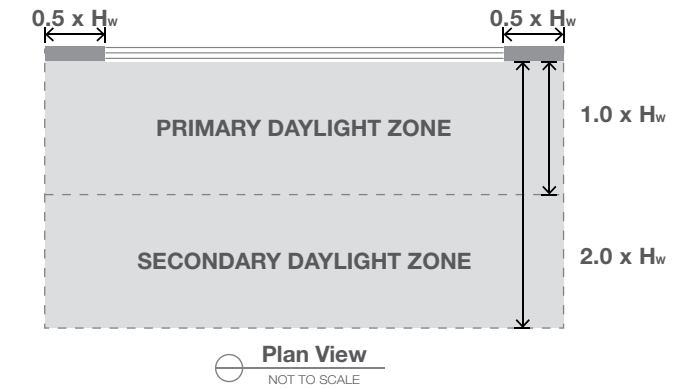
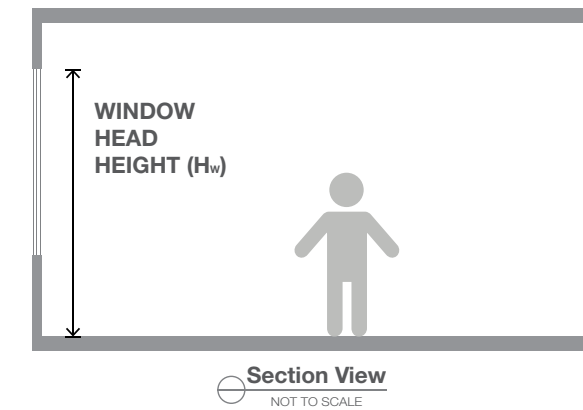

Toplighting (Skylight)

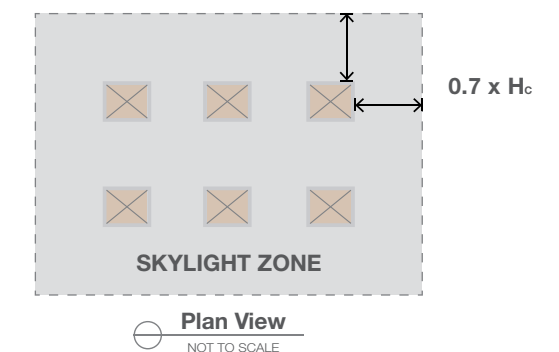
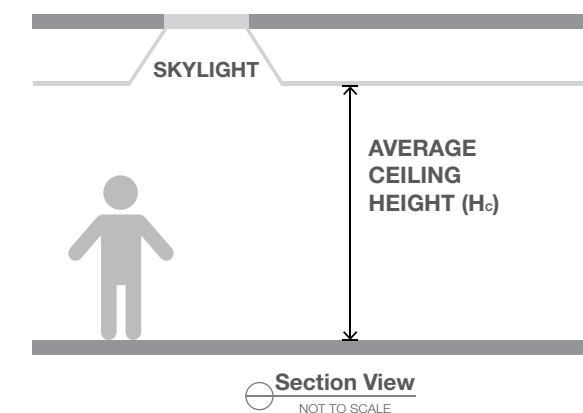

Suggested Code-Compliant Solutions

Title 24 2022

The compliant solutions listed below are suggested based on total installed cost, simplicity of design, and basic functional needs for the space. These solutions do not represent the only compliant options to meet lighting and receptacle control requirements. Applications in this guide will illustrate these solutions and/or alternate solutions for advanced functionality.

		Atrium	Classroom, Lecture Hall, Training Room	Conference, Break Room	Egress Corridor ²	Guestroom	Lobby	Open Office (>250 sq. ft.)
Local Control	Switching	⚙️	⚙️	⚙️	⚙️	⚙️	⚙️	⚙️
	Multi-level or dimming	🕒	🕒	🕒	🕒	🕒	🕒	🕒
Automatic Control⁵	Timeclock	⚙️						
	Occupancy sensor		⚙️	⚙️	⚙️	⚙️	⚙️	⚙️
	Full ON				⚙️		⚙️	⚙️
	Partial ON	⚙️	⚙️					
	Full OFF	⚙️	⚙️	⚙️		⚙️	⚙️	⚙️
	Partial OFF				⚙️			
Other	Daylight responsive control	🕒	🕒	🕒	🕒	🕒	🕒	🕒
	Receptacle control			🕒		🕒	🕒	🕒
	Demand response	🕒	🕒	🕒	🕒	🕒	🕒	🕒

1 Retrofit requirements indicated are for lighting alterations which replace more than 10% of the number of luminaires in the space, and use less than 80% of the maximum allowed lighting power. Or one-for-one luminaire replacements for buildings or tenant spaces less than 5,000 ft² when new lighting power is 40% lower than previous lighting power.

2 Up to 0.1 W per sq. ft. may be continuously illuminated for means of egress illumination.

3 Local control may be not accessible to unauthorized personnel.

4 Astronomical timeclock shall ensure the lights are off during daylight hours. Occupancy sensor shall provide Full ON and Partial OFF control. Occupancy sensing not required for lighting mounted higher than 24 feet.

5 Manual ON is always permitted for interior applications. Provide manual ON control when no automatic ON is indicated.

Suggested Code-Compliant Solutions

Title 24 2022

Diagram key:

🕒 = New construction

⚙️ = Lighting retrofit¹

⚙️🕒 = New construction and retrofit¹

Private Office (<250 sq. ft.)	Restaurant/ Cafeteria, Retail	Restroom ³	Egress Stairwell ^{2,3}	Storage Room	Warehouse Aisles, Library Stacks	Facade/ Landscape	Other Exterior ⁴
⚙️		⚙️	⚙️	⚙️	⚙️		
🕒	⚙️		🕒	🕒	🕒		
	⚙️					⚙️	⚙️
⚙️		⚙️	⚙️	⚙️	⚙️		⚙️
		⚙️	⚙️	⚙️		⚙️	⚙️
	⚙️						
⚙️	⚙️	⚙️		⚙️		⚙️	⚙️
			⚙️		⚙️		⚙️
	🕒 ⁶	🕒	🕒	🕒	🕒	🕒	🕒
🕒							
🕒	🕒	🕒	🕒	🕒	🕒	🕒	🕒

6 Luminaires in sidelit daylight zones in retail merchandise sales and wholesale showroom areas are exempt from daylight responsive controls.

This application guide is designed to help specifiers and contractors understand codes and Lutron controls in a simple manner. Each of the pages will lay out different spaces, the corresponding lighting control products for those spaces, and the way the system is set up in the space.

For Specifiers

Use this application guide for design suggestions, to understand the way the system operates, and to specify the relevant products for each space.

For Contractors

Use this application guide to understand how the system is installed, the way the system must operate, and to order the correct products for each application.

Understand how the products are laid out in the space

Learn more about the products used in the space

Room type | **Type of solution**

Classroom | New Construction
Title 24 2022

Symbol	Model Number	Description	Qty	List Price Each
	RMJS-8T-DV-B	PowPak dimming module with 0-10V	4	\$ 180.00
	LRF2-DCRB-WH	Radio Powr Savr wireless daylight sensor	1	\$ 150.00
	LRF2-OKLB-P-WH	Radio Powr Savr wireless, corner-mount occupancy sensor	1	\$ 105.00
	PJ2-3BRL-GWH-L01	Pico wireless, 3-button with raise/lower control	2	\$ 27.00
	PICO-WBX-ADAPT	Pico wallbox adapter	2	\$ 9.50
	HJS-1-FM	Vive wireless hub	Shared	Consult your local rep for hub pricing and service options.

Code Notes: For non-daylit classrooms, all general lighting can be connected to a single 0-10V dimming module. Go to lutron.com/Vive for complete compatibility and design details. This solution requires 0-10V enabled ballasts and drivers by others.

22

Classroom | New Construction
Title 24 2022

Visible System Components

Pico wireless control | Radio Powr Savr wireless, corner-mount occupancy sensor and daylight sensor

Control Functionality

Occupant Enters: All lights automatically turn on to 50% light level. Occupant turns on lights to maximum level manually. Maximum light level is set to 80%.

When Occupied: Automatic: Overhead lights dim/brighten based on daylight availability. There are two perimeter daylight zones. Manual: Occupant uses wall dimmers to set desired light levels for both general and white-board lights.

Occupant Exits: All lights automatically turn off 15 minutes after all occupants exit.

System Events: Demand Response: All lights automatically dim 20% during demand events.

Control Strategies

- Occupancy/Vacancy: Partial On, Auto Off
- Daylight Harvesting: Full On, Dim
- Dimming: Full On, Dim
- High-end Trim/Tuning: Max 100%, Max 85%
- Demand Response: Full On, Dim

Lighting Energy Savings*

60%

* Go to lutron.com/references for more information.

23

This guide offers up to three solutions per space type.

- The **Retrofit Solutions** are simple and inexpensive solutions, generally suited for a basic retrofit.
- The **New Construction Solutions** are value driven, generally best suited for new construction.
- The **Recommended Solutions** have advanced functionality for greater comfort and energy savings.

Type of solution

Learn about the products visible in the space and the different options available for these

Learn what strategies are implemented in the space







Learn what energy savings you achieve over manual shut-off

Understand how the space functions with the installed system

Vive Local Solutions Layout

Title 24 2022

This is a high-level overview of the local solutions layout. For individual room requirements refer to the detailed room type solutions in this guide. A single PowPak module can control a single fixture or multiple fixtures. The products shown here are representative of local solutions. Multiple product options are available to meet the needs of the space.

-  Vive wireless hub*
-  PowPak module
-  Occupancy sensor
-  Pico wireless remote control
-  Daylight sensor
-  Vive wireless receptacle



Vive wireless hub features:

- Central control, management, and monitoring of Vive devices via web browser
- Supports astronomic and time-of-day events
- Two contact closure inputs for third-party integration, such as Automatic Demand Response
- Wi-Fi access for easy commissioning
- Control up to 10,000 sq. ft. with a single hub
- Optional BACnet integration

* Go to lutron.com/vive for complete compatibility and design details.

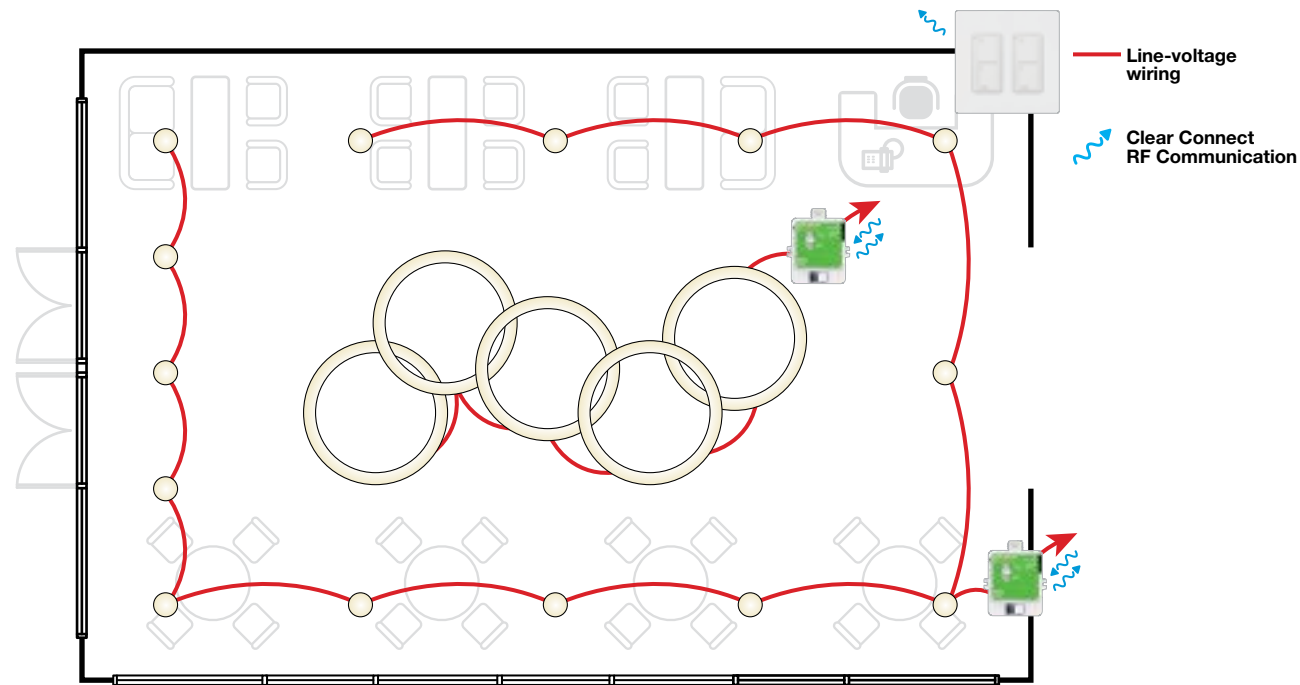



Symbol	Model Number	Description	Qty	List Price Each
	RMJS-16R-DV-B	PowPak switching module	2	\$ 155.00
	PJ2-2B-GWH-L01	Pico wireless 2-button control	2	\$ 27.00
	PICO-WBX-ADAPT	Pico wallbox adapter	2	\$ 9.50
	HJS-1-FM	Vive wireless hub	Shared	Consult your local rep for hub pricing and service options.

Code Notes: Requirements specified for atriums 20-40 ft. in height. Retrofit requirements indicated are for lighting alterations which replace more than 10% of the number of luminaires in the space, and use less than 80% of the maximum allowed lighting power. Or one-for-one luminaire replacements for buildings or tenant spaces less than 5,000 ft² when new lighting power is 40% lower than previous lighting power. Go to lutron.com/vive for complete compatibility and design details.

Visible System Components



Pico wireless control

Control Functionality

When Occupied:

Manual: Occupant uses wall switch to turn all lights off.

Timeclock:

Timeclock turns perimeter lights on during normally occupied hours.

Timeclock turns lights off during normally unoccupied hours.

Control Strategies

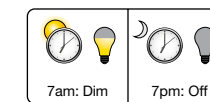

Scheduling

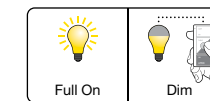

Dimming

Lighting Energy Savings*

10%

* Go to lutron.com/references for more information.

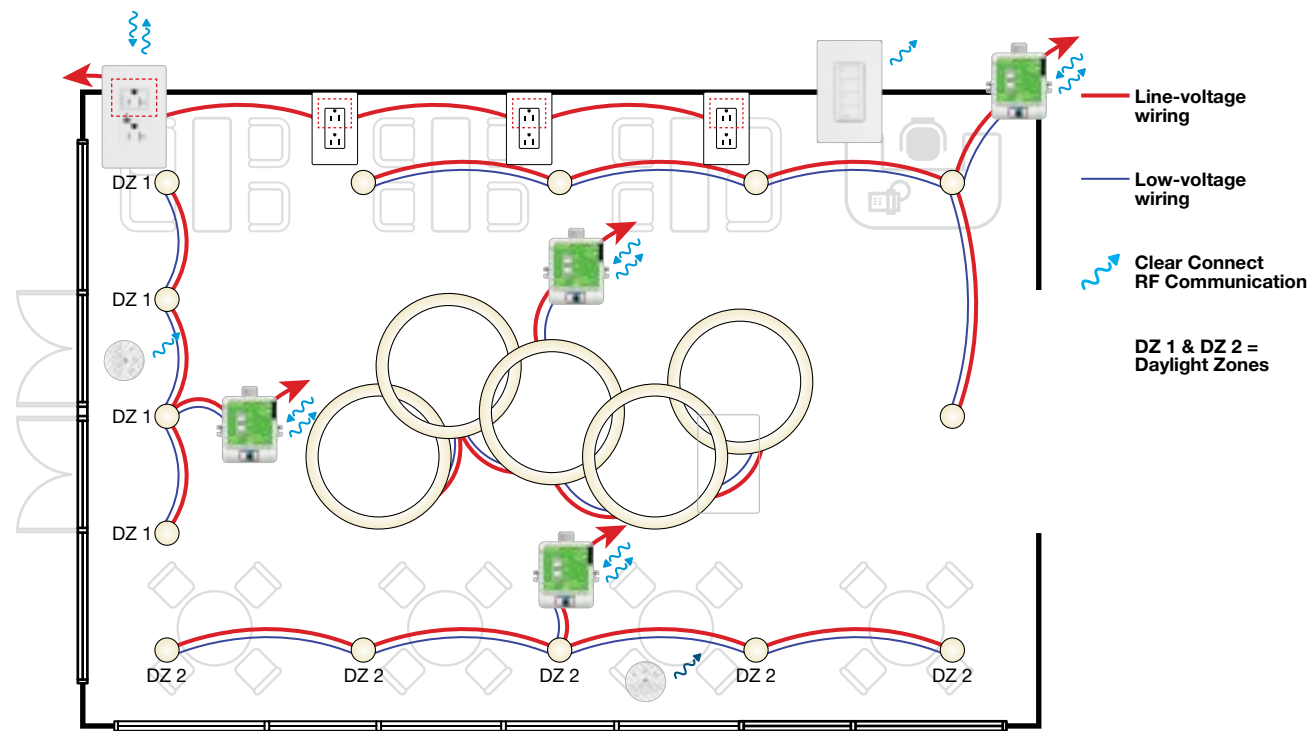

Visible System Components

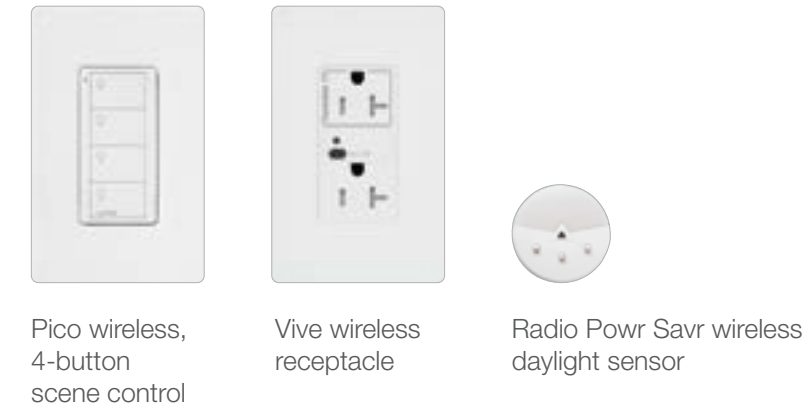

Control Functionality

When Occupied:
 Automatic: Overhead lights dim/brighten based on daylight availability. There are two perimeter daylight zones.

Manual: Occupant selects scenes to set desired light levels for all lights.

Timeclock:
 Timeclock turns all controlled receptacles on and lights on to 50% light level during normally occupied hours. Maximum light level is set to 80%.

Timeclock turns lights and controlled receptacles off during normally unoccupied hours.

System Events:
 Demand Response: All lights automatically dim 20% during demand events.

Control Strategies

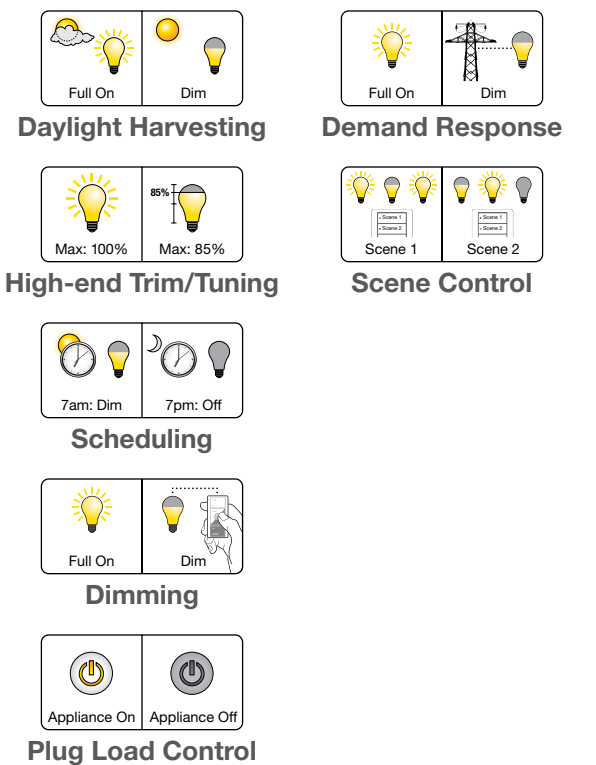

Symbol	Model Number	Description	Qty	List Price Each
	RMJS-8T-DV-B	PowPak dimming module with 0-10V	4	\$ 180.00
	CAR2S-20-STR-WH	Vive wireless receptacle	1	\$ 230.00
	LRF2-DCRB-WH	Radio Powr Savr wireless daylight sensor	2	\$ 150.00
	PJ2-4B-GWH-L31	Pico wireless, 4-button scene control	1	\$ 45.00
	PICO-WBX-ADAPT	Pico wallbox adapter	1	\$ 9.50
	HJS-1-FM	Vive wireless hub	Shared	Consult your local rep for hub pricing and service options.

Code Notes: Requirements specified for 20-40 ft. atriums. Go to lutron.com/vive for complete compatibility and design details. This solution requires 0-10V enabled ballasts and drivers by others.

Lighting Energy Savings*

60%

* Go to lutron.com/references for more information.

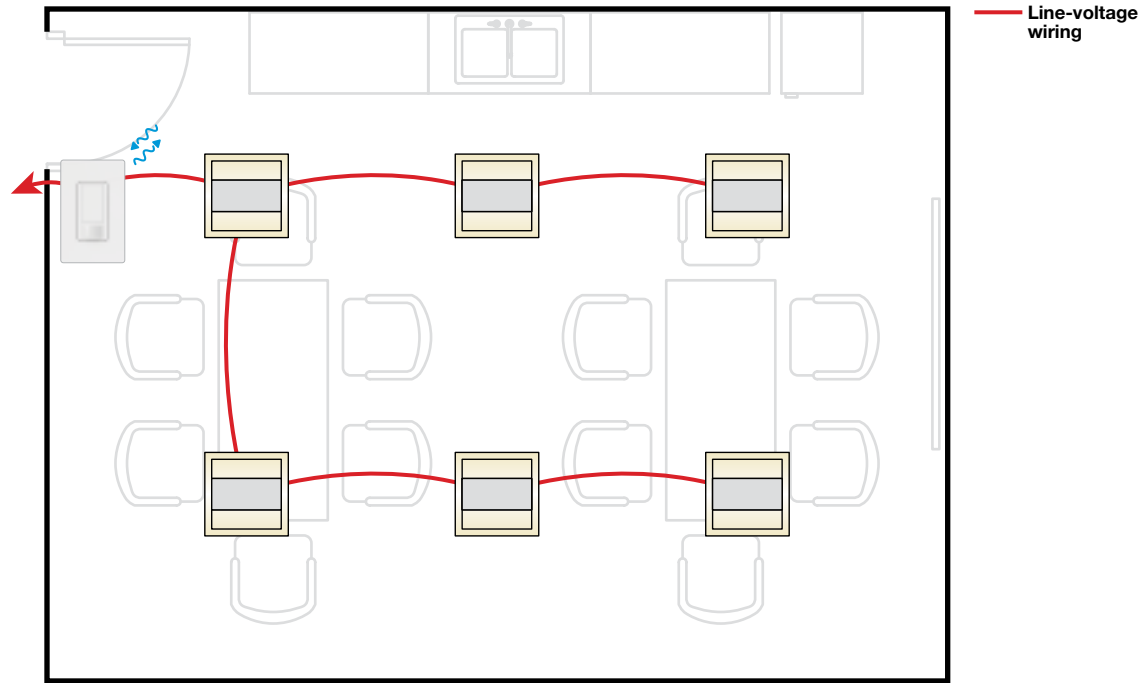

Symbol	Model Number	Description	Qty	List Price Each
	MRF2S-8SSV-WH	Maestro Wireless sensor switch	1	\$ 190.00

Code Notes: Retrofit requirements indicated are for lighting alterations which replace more than 10% of the number of luminaires in the space, and use less than 80% of the maximum allowed lighting power. Or, one-for-one luminaire replacements for buildings or tenant spaces less than 5,000 ft² when new lighting power is 40% lower than previous lighting power.

Visible System Components



Maestro vacancy sensor switch

Control Functionality

Occupant Enters:

Lights do not automatically turn on when an occupant enters the space; lights must be turned on manually.

When Occupied:

Manual: Occupant uses wall switch to turn all lights off.

Occupant Exits:

All lights automatically turn off 15 minutes after all occupants exit.

Control Strategies

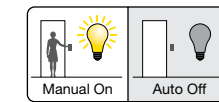

Occupancy/Vacancy

Lighting Energy Savings*

30%

* Go to lutron.com/references for more information.

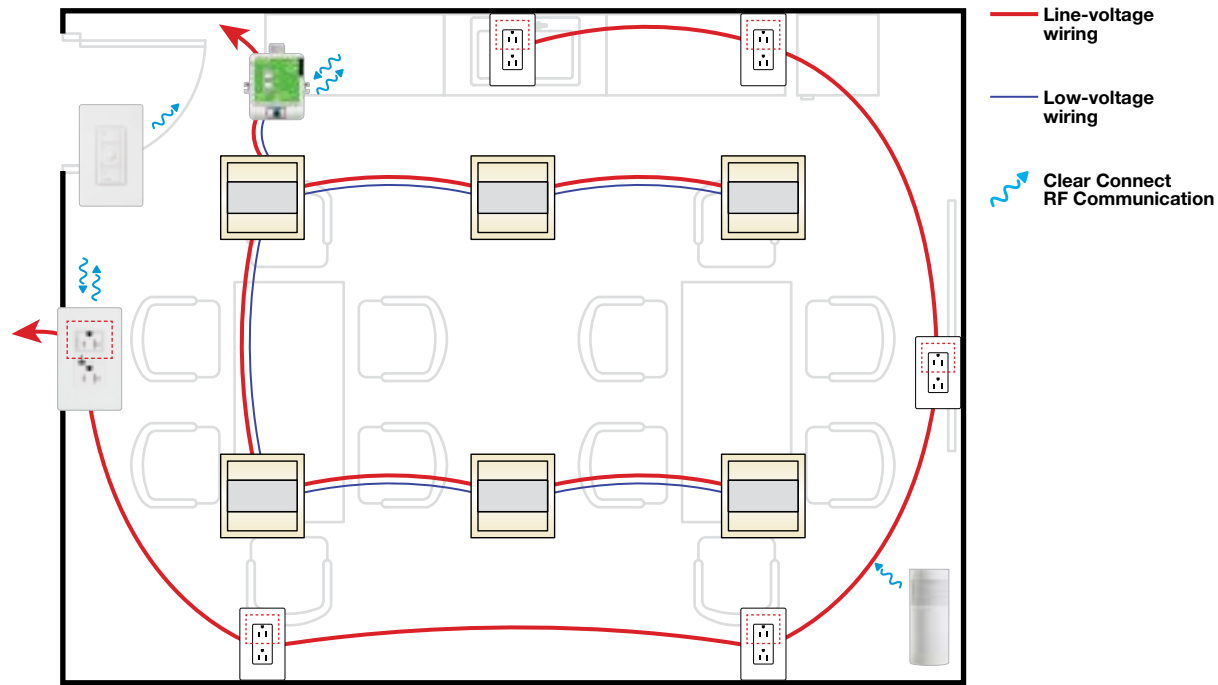

Symbol	Model Number	Description	Qty	List Price Each
	RMJS-8T-DV-B	PowPak dimming module with 0-10V	1	\$ 180.00
	CAR2S-20-STR-WH	Vive wireless receptacle	1	\$ 230.00
	LRF2-VKLB-P-WH	Radio Powr Savr wireless, corner-mount vacancy sensor	1	\$ 105.00
	PJ2-3BRL-GWH-L01	Pico wireless, 3-button with raise/lower control	1	\$ 27.00
	PICO-WBX-ADAPT	Pico wallbox adapter	1	\$ 9.50
	HJS-1-FM	Vive wireless hub	Shared	Consult your local rep for hub pricing and service options.

Code Notes: For break rooms with daylight, include a 0-10V dimming module per zone and a daylight sensor. Go to lutron.com/vive for complete compatibility and design details. This solution requires 0-10V enabled ballasts and drivers by others.

Visible System Components



Control Functionality

Occupant Enters: Lights do not automatically turn on when an occupant enters the space; lights must be turned on manually. Maximum light level is set to 80%.

Controlled receptacles automatically regain power when occupant enters.

When Occupied: Manual: Occupant uses wall dimmer to set desired light levels for all lights.

Occupant Exits: All lights automatically turn off 15 minutes after all occupants exit.

50% of all receptacles automatically turn off 15 minutes after all occupants exit.

System Events: Demand Response: All lights automatically dim 20% during demand events.

Control Strategies

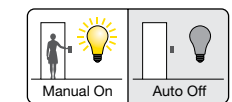

Occupancy/Vacancy

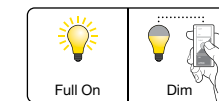

Dimming

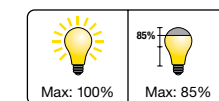

High-end Trim/Tuning

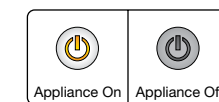

Plug Load Control

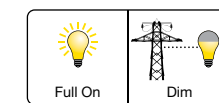

Demand Response



Lighting Energy Savings*

45%

* Go to lutron.com/references for more information.

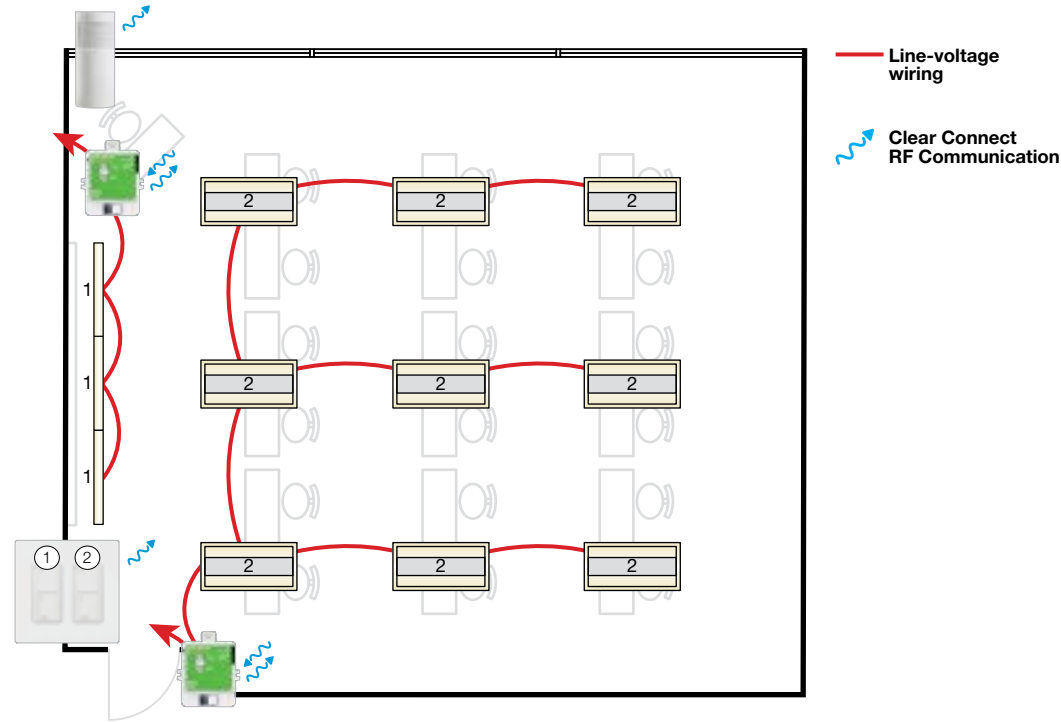



Symbol	Model Number	Description	Qty	List Price Each
	RMJS-16R-DV-B	PowPak switching module	2	\$ 155.00
	LRF2-VKLB-P-WH	Radio Powr Savr wireless, corner-mount vacancy sensor	1	\$ 105.00
	PJ2-2B-GWH-L01	Pico wireless 2-button control	2	\$ 27.00
	PICO-WBX-ADAPT	Pico wallbox adapter	2	\$ 9.50

Code Notes: Retrofit requirements indicated are for lighting alterations which replace more than 10% of the number of luminaires in the space, and use less than 80% of the maximum allowed lighting power. Or, one-for-one luminaire replacements for buildings or tenant spaces less than 5,000 ft² when new lighting power is 40% lower than previous lighting power.

Visible System Components



Pico wireless control



Radio Powr Savr wireless, corner-mount vacancy sensor

Control Functionality

Occupant Enters:

Lights do not automatically turn on when an occupant enters the space; lights must be turned on manually.

When Occupied:

Manual: Occupant uses wall switches to turn on and off general and white-board lighting.

Occupant Exits:

All lights automatically turn off 15 minutes after all occupants exit.

Control Strategies

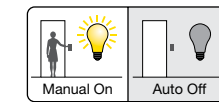

Occupancy/Vacancy

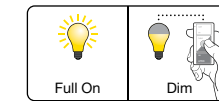

Dimming

Lighting Energy Savings*

45%

* Go to lutron.com/references for more information.

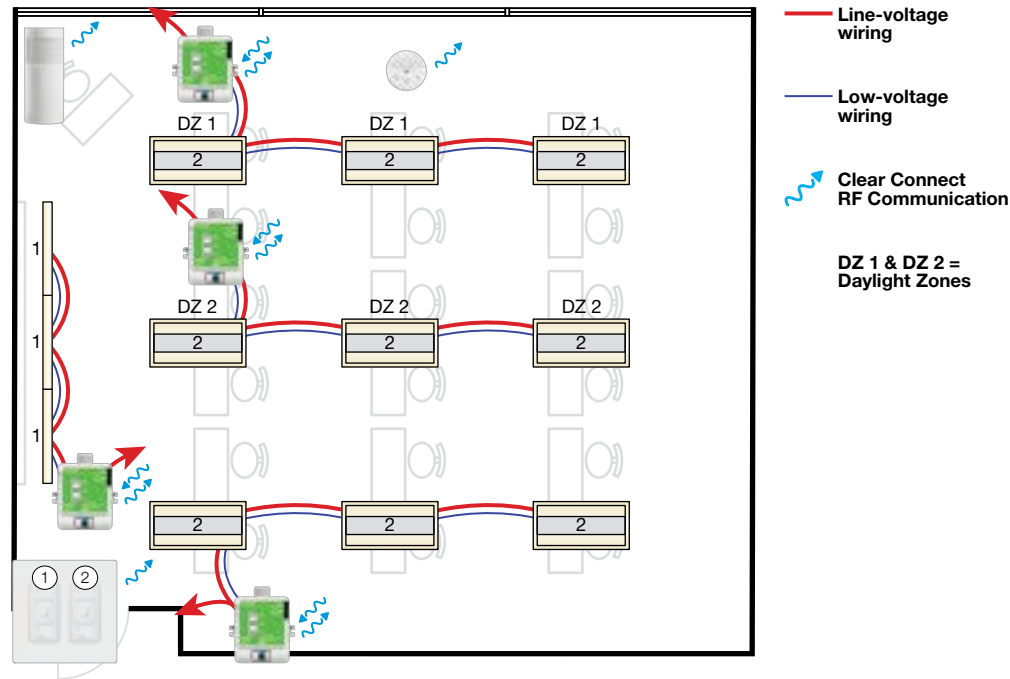

Symbol	Model Number	Description	Qty	List Price Each
	RMJS-8T-DV-B	PowPak dimming module with 0-10V	4	\$ 180.00
	LRF2-DCRB-WH	Radio Powr Savr wireless daylight sensor	1	\$ 150.00
	LRF2-OKLB-P-WH	Radio Powr Savr wireless, corner-mount occupancy sensor	1	\$ 105.00
	PJ2-3BRL-GWH-L01	Pico wireless, 3-button with raise/lower control	2	\$ 27.00
	PICO-WBX-ADAPT	Pico wallbox adapter	2	\$ 9.50
	HJS-1-FM	Vive wireless hub	Shared	Consult your local rep for hub pricing and service options.

Code Notes: For non-daylit classrooms, all general lighting can be connected to a single 0-10V dimming module. Go to lutron.com/vive for complete compatibility and design details. This solution requires 0-10V enabled ballasts and drivers by others.

Visible System Components



Pico wireless control



Radio Powr Savr wireless, corner-mount occupancy sensor and daylight sensor

Control Functionality

Occupant Enters:

All lights automatically turn on to 50% light level. Occupant turns on lights to maximum level manually. Maximum light level is set to 80%.

When Occupied:

Automatic: Overhead lights dim/brighten based on daylight availability. There are two perimeter daylight zones.

Manual: Occupant uses wall dimmers to set desired light levels for both general and white-board lights.

Occupant Exits:

All lights automatically turn off 15 minutes after all occupants exit.

System Events:

Demand Response: All lights automatically dim 20% during demand events.

Control Strategies

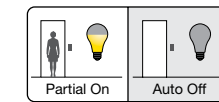

Occupancy/Vacancy

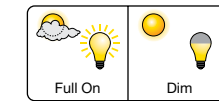

Daylight Harvesting

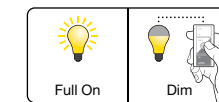

Dimming

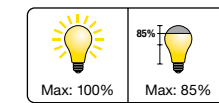

High-end Trim/Tuning

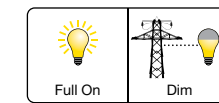

Demand Response

Lighting Energy Savings*

60%

* Go to lutron.com/references for more information.

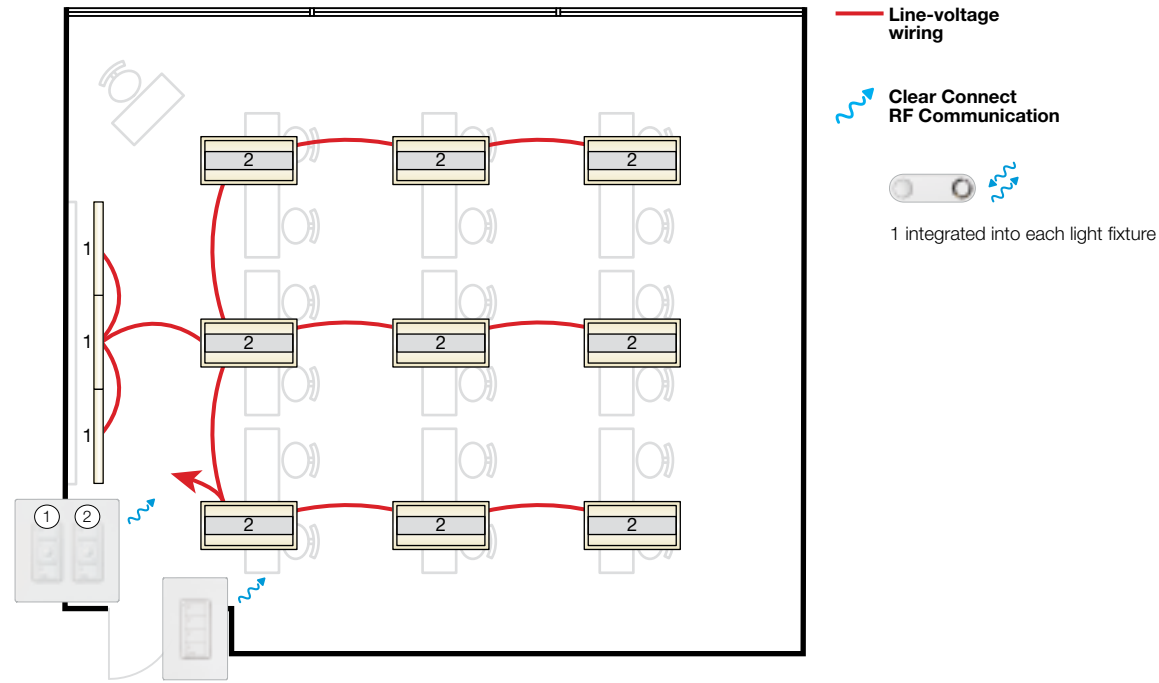

Symbol	Model Number	Description	Qty	List Price Each
	Integral to fixture ¹	Integral fixture control with sensor	12	\$ 78.00 ²
	PJ2-4B-GWH-L31	Pico wireless, 4-button scene control	1	\$ 45.00
	PJ2-3BRL-GWH-L01	Pico wireless, 3-button with raise/lower control	2	\$ 27.00
	PICO-WBX-ADAPT	Pico wallbox adapter	3	\$ 9.50
	HJS-1-FM	Vive wireless hub	Shared	Consult your local rep for hub pricing and service options.

¹ Fixture control comes pre-installed in fixture. Look for the Clear Connect Wireless symbol for fixtures containing this module. Go to lutron.com/findafixture for a complete list of compatible fixtures and drivers.
² Fixture adder for the control module may vary.



This solution requires digitally enabled ballasts and drivers by others.

Visible System Components



Pico wireless control



Pico wireless 4-button scene control



Integral fixture control with sensor

Control Functionality

Occupant Enters:

All lights automatically turn on to 50% light level. Occupant turns on lights to maximum level manually. Maximum light level is set to 80%.

When Occupied:

Automatic: Overhead lights dim/brighten based on daylight availability. There are two perimeter daylight zones.

Manual: Occupant selects scenes or uses dimmers to set desired light levels for all lights. Entry scene controller has 3 user-preferred presets and 1 all-off button.

Occupant Exits:

All lights automatically turn off 15 minutes after all occupants exit.

System Events:

Demand Response: All lights automatically dim 20% during demand events.

Control Strategies

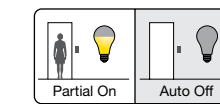

Occupancy/Vacancy

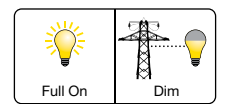

Demand Response

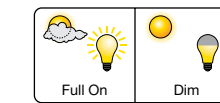

Daylight Harvesting

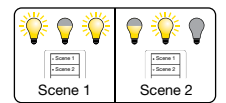

Scene Control

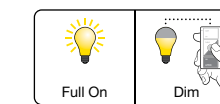

Dimming

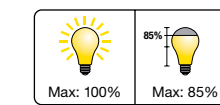





High-end Trim/Tuning

Lighting Energy Savings*

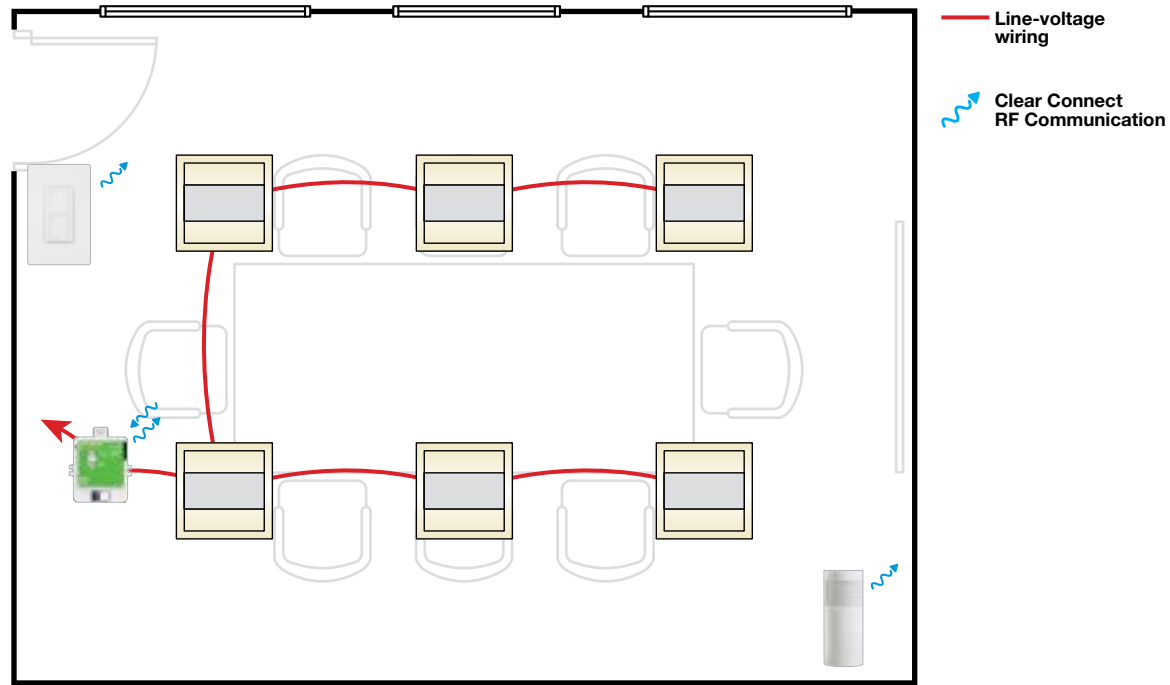
60%

* Go to lutron.com/references for more information.



Symbol	Model Number	Description	Qty	List Price Each
	RMJS-16R-DV-B	PowPak switching module	1	\$ 155.00
	LRF2-VKLB-P-WH	Radio Powr Savr wireless, corner-mount vacancy sensor	1	\$ 105.00
	PJ2-2B-GWH-L01	Pico wireless 2-button control	1	\$ 27.00
	PICO-WBX-ADAPT	Pico wallbox adapter	1	\$ 9.50

Code Notes: Retrofit requirements indicated are for lighting alterations which replace more than 10% of the number of luminaires in the space, and use less than 80% of the maximum allowed lighting power. Or, one-for-one luminaire replacements for buildings or tenant spaces less than 5,000 ft² when new lighting power is 40% lower than previous lighting power. Want to add a Vive wireless hub for more features? Go to lutron.com/vive for complete compatibility and design details.

Visible System Components



Pico wireless control



Radio Powr Savr wireless, corner-mount vacancy sensor

Control Functionality

Occupant Enters: Lights do not automatically turn on when an occupant enters the space; lights must be turned on manually.

When Occupied: Manual: Occupant uses wall switch to turn all lights off.

Occupant Exits: All lights automatically turn off 15 minutes after all occupants exit.

Control Strategies

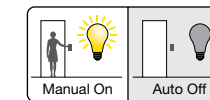

Occupancy/Vacancy

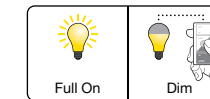

Dimming

Lighting Energy Savings*

40%

* Go to lutron.com/references for more information.



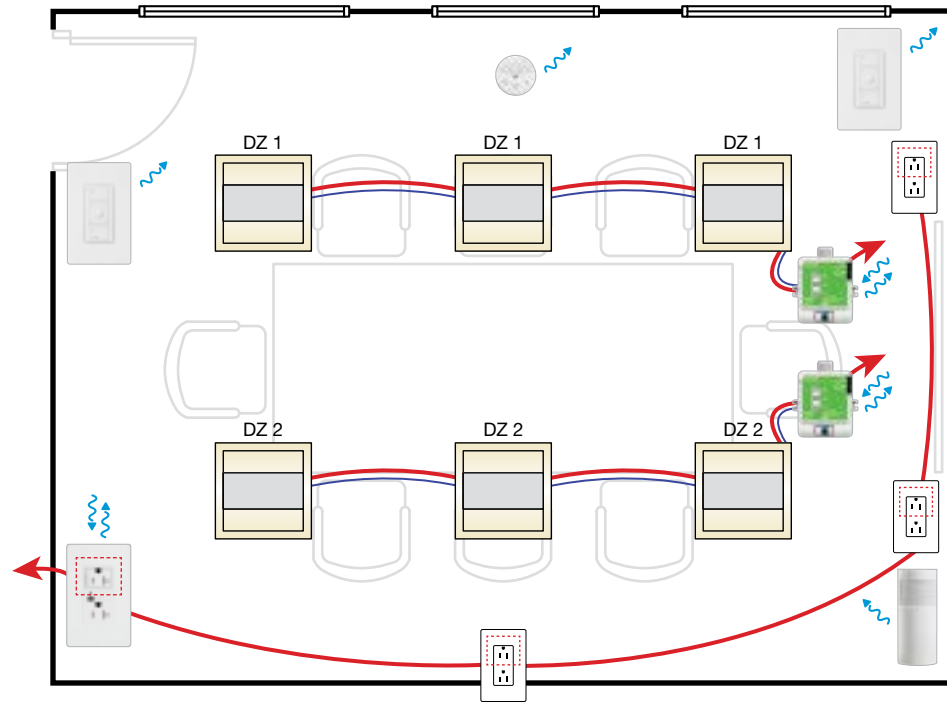

- Line-voltage wiring
- Low-voltage wiring
- ~ Clear Connect RF Communication
- DZ 1 & DZ 2 = Daylight Zones**

Symbol	Model Number	Description	Qty	List Price Each
	RMJS-8T-DV-B	PowPak dimming module with 0-10V	2	\$ 180.00
	CAR2S-20-STR-WH	Vive wireless receptacle	1	\$ 230.00
	LRF2-DCRB-WH	Radio Powr Savr wireless daylight sensor	1	\$ 150.00
	LRF2-VKLB-P-WH	Radio Powr Savr wireless, corner-mount vacancy sensor	1	\$ 105.00
	PJ2-3BRL-GWH-L01	Pico wireless, 3-button with raise/lower control	2	\$ 27.00
	PICO-WBX-ADAPT	Pico wallbox adapter	2	\$ 9.50
	HJS-1-FM	Vive wireless hub	Shared	Consult your local rep for hub pricing and service options.

Code Notes: For non-daylit conference rooms, all general lighting can be connected to a single 0-10V dimming module. Want to add a Vive wireless hub for more features? Go to lutron.com/vive for complete compatibility and design details. This solution requires 0-10V enabled ballasts and drivers by others.

Visible System Components



Pico wireless control
 Vive wireless receptacle
 Radio Powr Savr wireless, corner-mount vacancy sensor and daylight sensor

Control Functionality

Occupant Enters: Lights do not automatically turn on when an occupant enters the space; lights must be turned on manually. Maximum light level is set to 80%.

Controlled receptacles automatically regain power when occupant enters.

When Occupied: Automatic: Overhead lights dim/brighten based on daylight availability. There are two perimeter daylight zones.

Manual: Occupant uses wall dimmer to set desired light levels for all lights.

Occupant Exits: All lights automatically turn off 15 minutes after all occupants exit.

50% of all receptacles automatically turn off 15 minutes after all occupants exit.

System Events: Demand Response: All lights automatically dim 20% during demand events.

Control Strategies

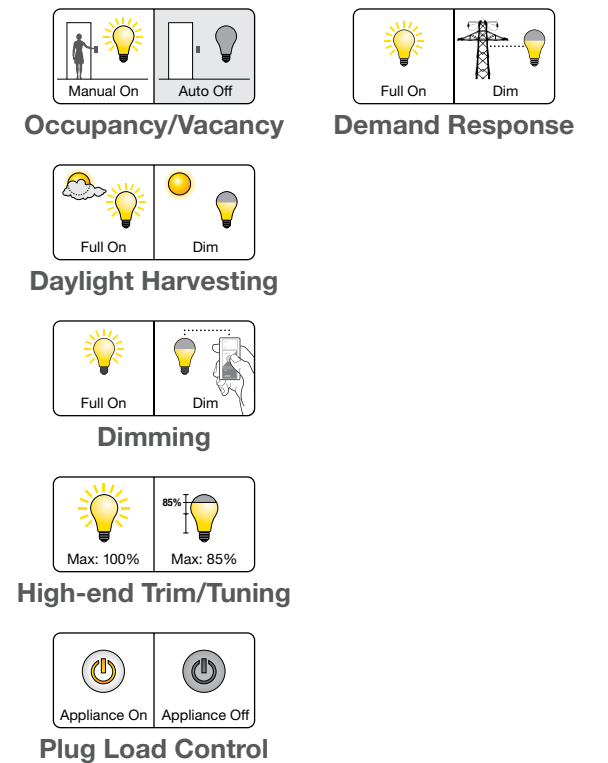

Lighting Energy Savings*

60%

* Go to lutron.com/references for more information.

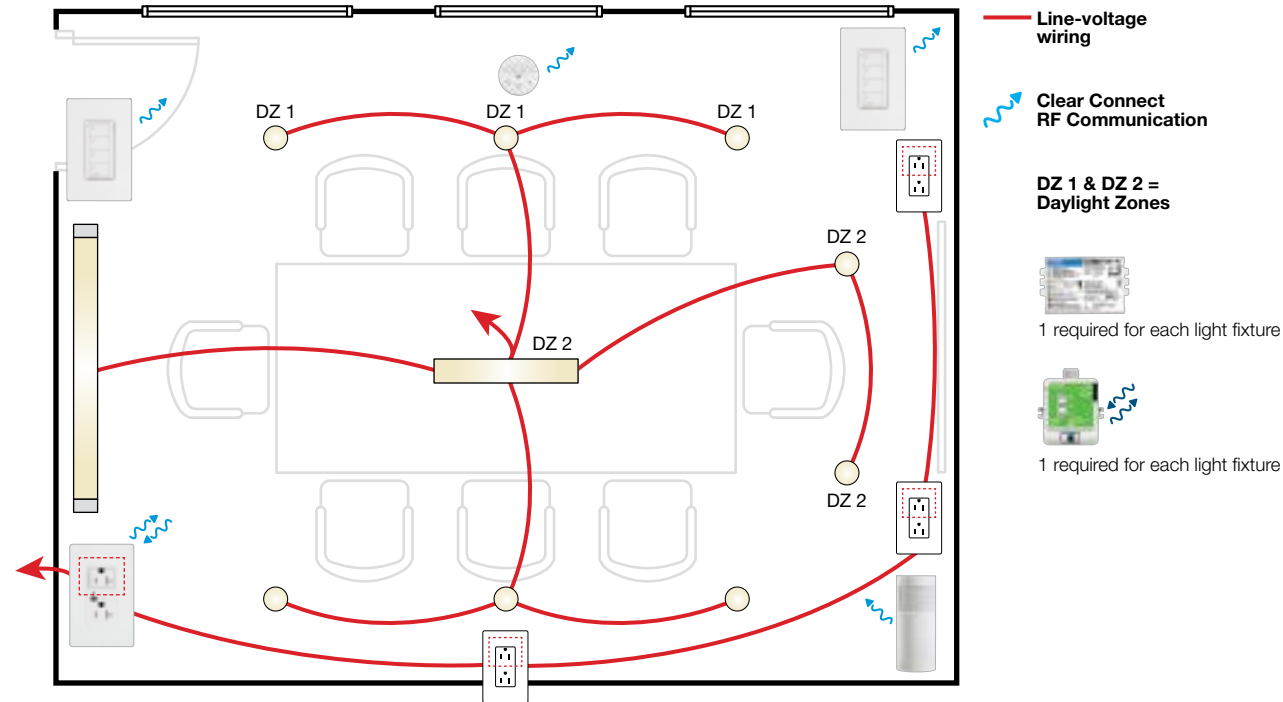

Symbol	Model Number	Description	Qty	List Price Each
	Multiple	EcoSystem-enabled Hi-lume Soft-on, Fade-to-Black series ballasts/drivers	10	Consult your local rep for in-fixture pricing.
	FCJS-ECO	Wireless fixture control with EcoSystem	10	\$ 91.00
	CAR2S-20-STR-WH	Vive wireless receptacle	1	\$ 230.00
	LRF2-DCRB-WH	Radio Powr Savr wireless daylight sensor	1	\$ 150.00
	LRF2-VKLB-P-WH	Radio Powr Savr wireless, corner-mount vacancy sensor	1	\$ 105.00
	PJ2-4B-GWH-L31	Pico wireless, 4-button scene control	2	\$ 45.00
	PICO-WBX-ADAPT	Pico wallbox adapter	2	\$ 9.50
	HJS-1-FM	Vive wireless hub	Shared	Consult your local rep for hub pricing and service options.

Visible System Components

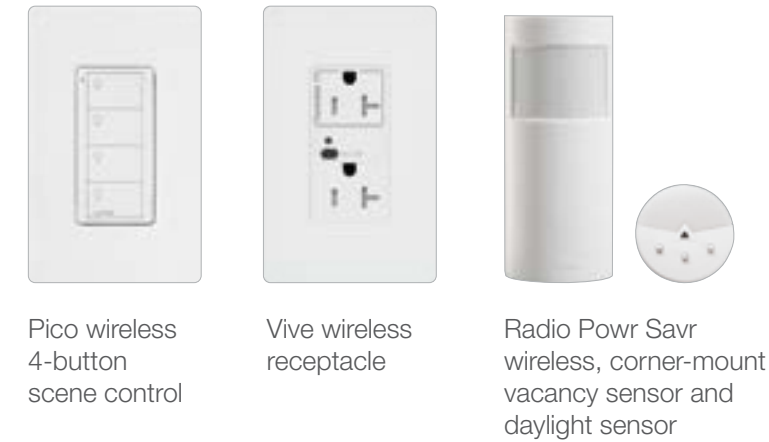

Control Functionality

Occupant Enters:
Lights do not automatically turn on when an occupant enters the space; lights must be turned on manually. Maximum light level is set to 80%.

Controlled receptacles automatically regain power when occupant enters.

When Occupied:
Automatic: Overhead lights dim/brighten based on daylight availability. There is one perimeter daylight zone.

Manual: Occupant selects scenes to set desired light levels for all lights. Entry scene controller has 3 user-preferred presets and 1 all-off button.

Occupant Exits:
All lights automatically turn off 15 minutes after all occupants exit.

50% of all receptacles automatically turn off 15 minutes after all occupants exit.

System Events:
Demand Response: All lights automatically dim 20% during demand events.

Control Strategies

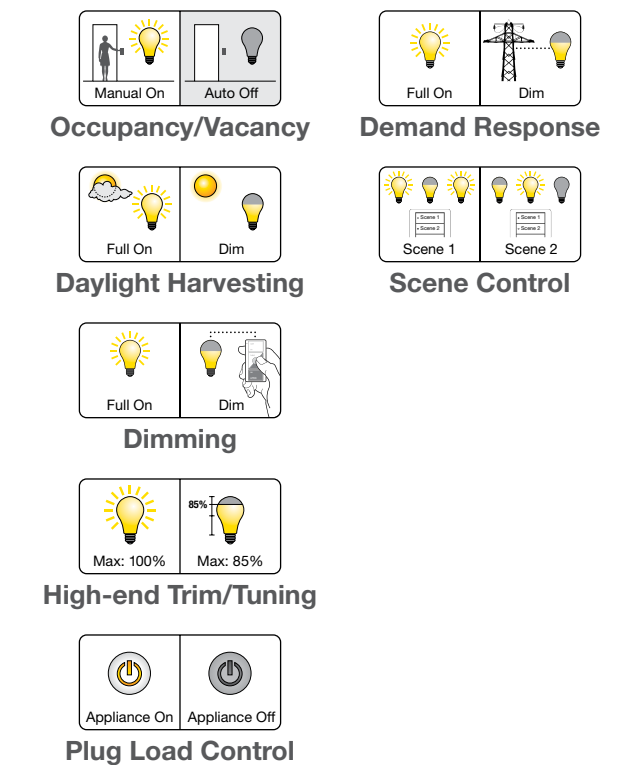

Lighting Energy Savings*

60%

* Go to lutron.com/references for more information.

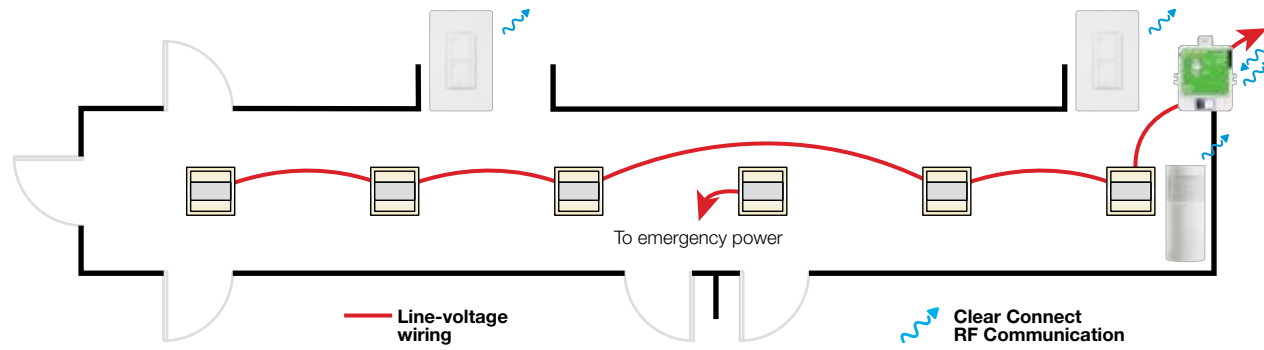

Visible System Components



Pico wireless control



Radio Powr Savr wireless, hallway occupancy sensor



Control Functionality

Occupant Enters:

All lights automatically turn on to maximum light level.

When Occupied:

Manual: Occupant uses wall switch to turn all non-emergency lights off.



Occupant Exits:

All non-emergency lights automatically turn off 15 minutes after all occupants exit.

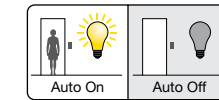
Control Strategies



Occupancy/Vacancy

Symbol	Model Number	Description	Qty	List Price Each
	RMJS-16R-DV-B	PowPak switching module	1	\$ 155.00
	LRF2-OHLB-P-WH	Radio Powr Savr wireless, hallway occupancy sensor	1	\$ 105.00
	PJ2-2B-GWH-L01	Pico wireless 2-button control	2	\$ 27.00
	PICO-WBX-ADAPT	Pico wallbox adapter	2	\$ 9.50

Code Notes: Retrofit requirements indicated are for lighting alterations which replace more than 10% of the number of luminaries in the space, and use less than 80% of the maximum allowed lighting power. Or, one-for-one luminaire replacements for buildings or tenant spaces less than 5,000 ft² when new lighting power is 40% lower than previous lighting power. Up to 0.2 W may be continuously illuminated for means of egress illumination. Local control may be not accessible to unauthorized personnel.

Want to add a Vive wireless hub for more features? Go to lutron.com/vive for complete compatibility and design details.

Lighting Energy Savings*

40%

* Go to lutron.com/references for more information.

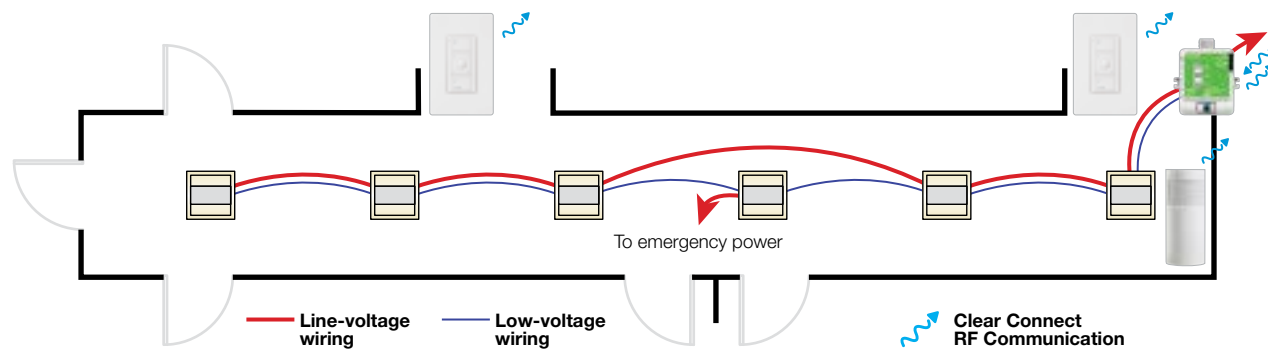

Symbol	Model Number	Description	Qty	List Price Each
	RMJS-8T-DV-B	PowPak dimming module with 0-10V	1	\$ 180.00
	LRF2-OHLB-P-WH	Radio Powr Savr wireless, hallway occupancy sensor	1	\$ 105.00
	PJ2-3BRL-GWH-L01	Pico wireless, 3-button with raise/lower control	2	\$ 27.00
	PICO-WBX-ADAPT	Pico wallbox adapter	2	\$ 9.50
	HJS-1-FM	Vive wireless hub	Shared	Consult your local rep for hub pricing and service options.

Code Notes: Verify that the egress fixtures go to full output upon loss of control signal. For projects that require UL 924 compliance, provide an automatic load control relay (ALCR) per load controller connected to emergency fixtures. Add a daylight sensor for corridors with daylight zones. Want to add a Vive wireless hub for more features? Go to lutron.com/vive for complete compatibility and design details. This solution requires 0-10V enabled ballasts and drivers by others. Up to 0.1 W per sq. ft. may be continuously illuminated for means of egress illumination. Local control may be not accessible to unauthorized personnel.

Visible System Components



Pico wireless control



Radio Powr Savr wireless, hallway occupancy sensor

Control Functionality

Occupant Enters:

All lights automatically turn on to maximum light level. Maximum light level is set to 80%.

When Occupied:

Manual: Occupant uses wall dimmer to set desired light levels for all lights. Manual control cannot fully shut off the lights. Minimum light level is set to 10%.

Occupant Exits:

All lights automatically go to minimum light level 15 minutes after all occupants exit.

Emergency Mode:

Lighting connected to emergency power turns on to full output.

System Events:

Demand Response: All lights automatically dim 20% during demand response event. Demand response cannot shut off the lights.

Control Strategies

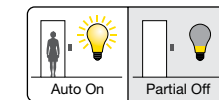

Occupancy/Vacancy

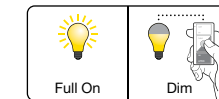

Dimming

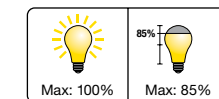

High-end Trim/Tuning

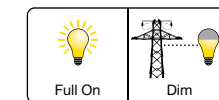

Demand Response

Lighting Energy Savings*

60%

* Go to lutron.com/references for more information.

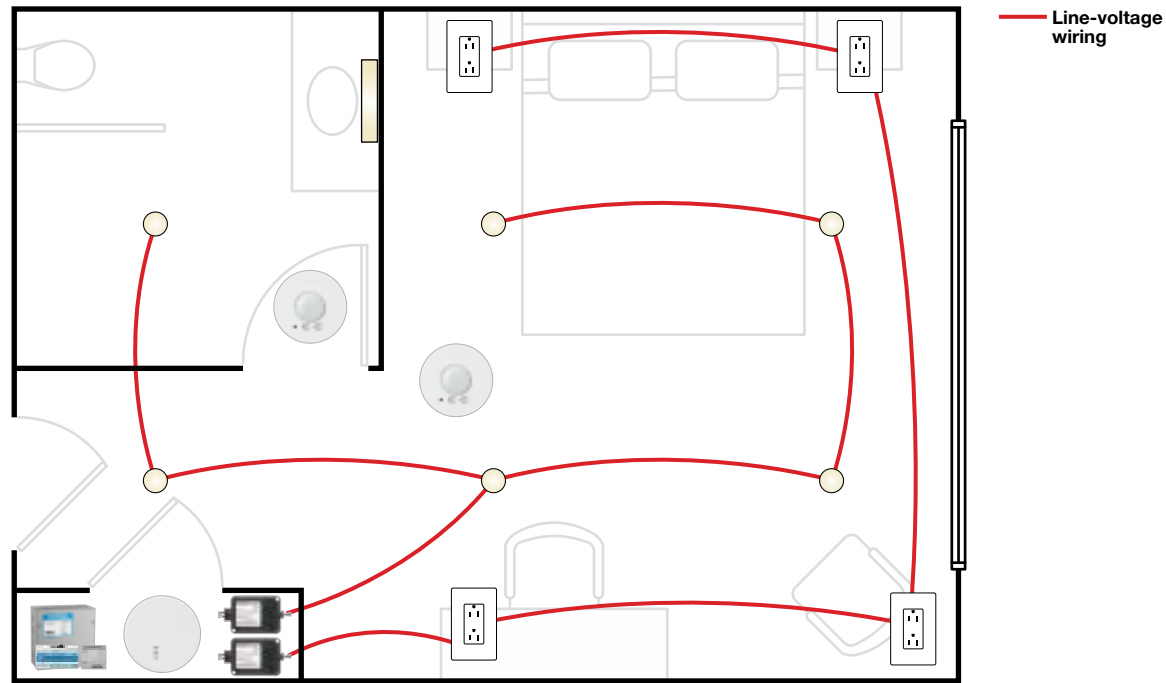

Symbol	Model Number	Description	Voltage	Qty	List Price Each
	CCGS-NA-2	Two-circuit Guestroom Package; includes all products listed below	N/A	1	\$ 1,120.00
	LUT-8X8-ENC with MQSE-2S1-D and MQSPS-DH-1-30	Lutron-provided enclosure, switching load controller, myRoom power supply	120V	1	N/A
	QSM2-XW-C	QS sensor module	120V	1	N/A
	PP-DV	Relay power pack (lighting)	120V	1	N/A
	CU300HD-CPN6814	Relay power pack (receptacles)	120V	1	N/A
	LRF2-OCR2B-P-WH	Radio Powr Savr wireless, ceiling-mount occupancy sensor	N/A	2	N/A

Visible System Components



Radio Powr Savr wireless, ceiling-mount occupancy sensor

Control Functionality

Occupant Enters:
Controlled receptacles turn on and all lights will return to previous levels from when the room was vacated.

When Occupied:
Manual: Occupant uses wall dimmer to set desired light levels for all lights.

Occupant Exits:
All lights and controlled receptacles go off 15 minutes after all occupants exit.

Control Strategies

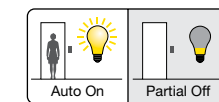

Occupancy/Vacancy

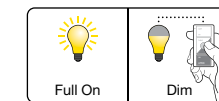

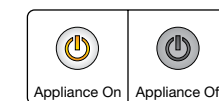

Dimming

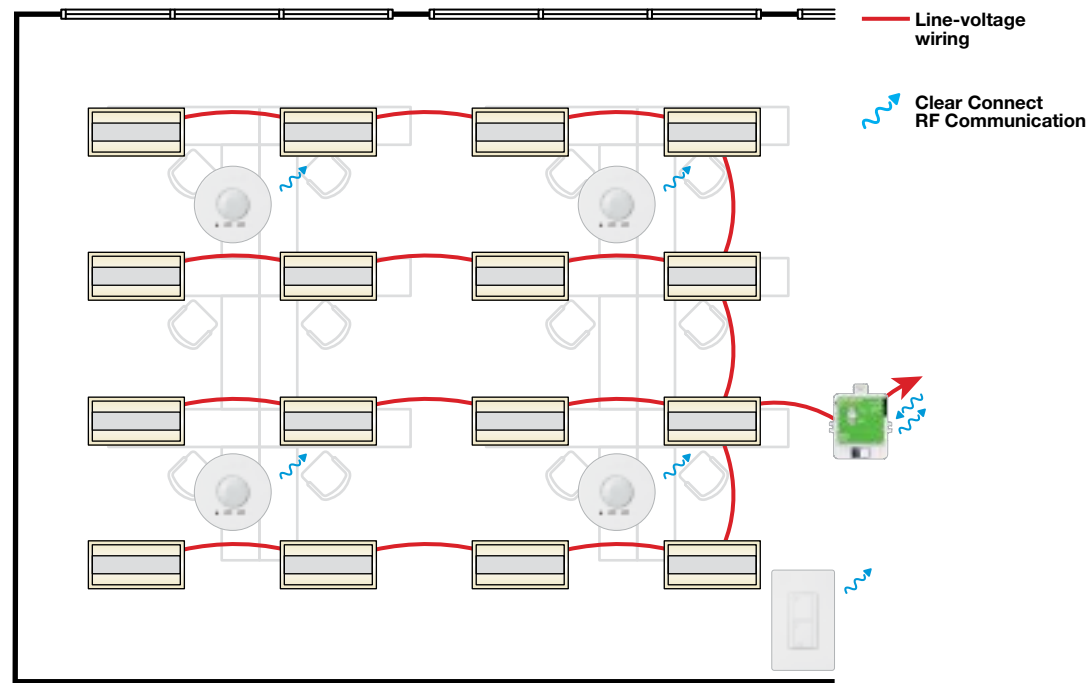

Plug Load Control



Symbol	Model Number	Description	Qty	List Price Each
	RMJS-16R-DV-B	PowPak switching module	1	\$ 155.00
	LRF2-OCR2B-P-WH	Radio Powr Savr wireless, ceiling-mount occupancy sensor	4	\$ 105.00
	PJ2-2B-GWH-L01	Pico wireless 2-button control	1	\$ 27.00
	PICO-WBX-ADAPT	Pico wallbox adapter	1	\$ 9.50

Code Notes: Retrofit requirements indicated are for lighting alterations which replace more than 10% of the number of luminaries in the space, and use less than 80% of the maximum allowed lighting power. Or one-for-one luminaire replacements for buildings or tenant spaces less than 5,000 ft² when new lighting power is 40% lower than previous lighting power. Want to add a Vive wireless hub for more features? Go to lutron.com/vive for complete compatibility and design details.

Visible System Components



Pico wireless control



Radio Powr Savr wireless, ceiling-mount occupancy sensor

Control Functionality

Occupant Enters:
All lights automatically turn on to maximum light level.

When Occupied:
Manual: Occupant uses wall switch to turn all lights off.

Occupant Exits:
All lights automatically turn off 15 minutes after all occupants exit.

Control Strategies

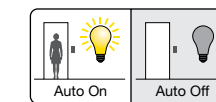

Occupancy/Vacancy

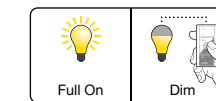

Dimming

Lighting Energy Savings*

35%

* Go to lutron.com/references for more information.

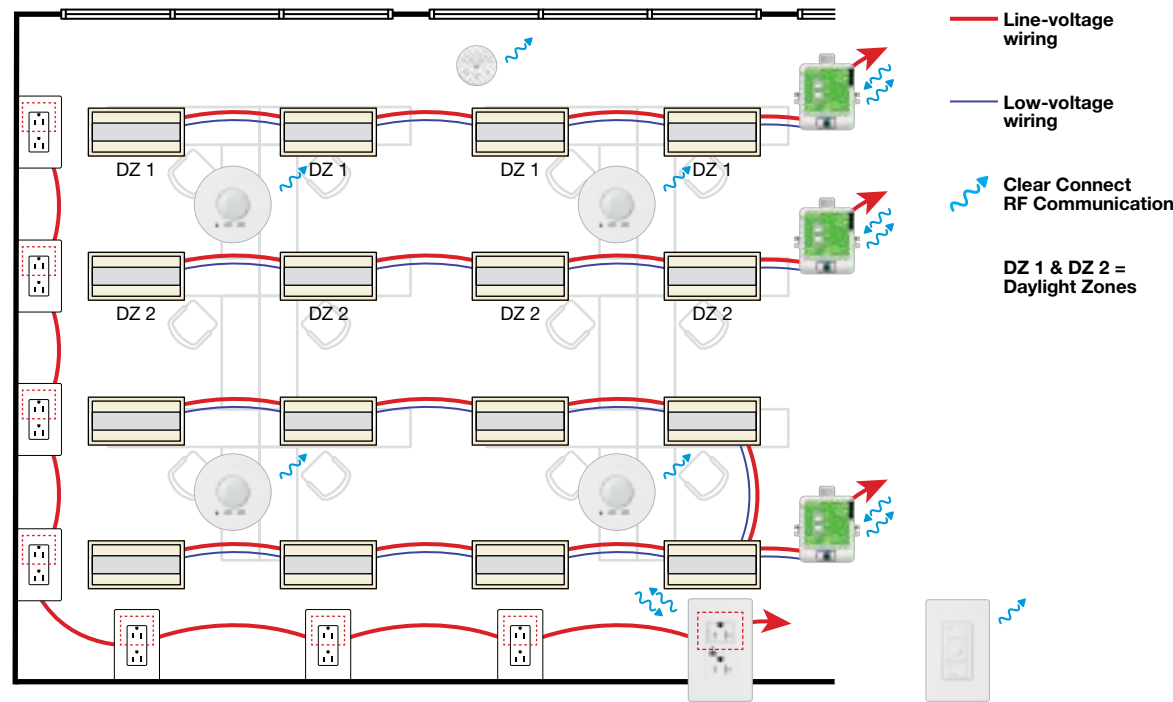

Symbol	Model Number	Description	Qty	List Price Each
	RMJS-8T-DV-B	PowPak dimming module with 0-10V	3	\$ 180.00
	CAR2S-20-STR-WH	Vive wireless receptacle	1	\$ 230.00
	LRF2-DCRB-WH	Radio Powr Savr wireless daylight sensor	1	\$ 150.00
	LRF2-OCR2B-P-WH	Radio Powr Savr wireless, ceiling-mount occupancy sensor	4	\$ 105.00
	PJ2-3BRL-GWH-L01	Pico wireless, 3-button with raise/lower control	1	\$ 27.00
	PICO-WBX-ADAPT	Pico wallbox adapter	1	\$ 9.50
	HJS-1-FM	Vive wireless hub	Shared	Consult your local rep for hub pricing and service options.

Code Notes: For non-daylit open offices, all general lighting can be connected to a single 0-10V dimming module. Go to lutron.com/vive for complete compatibility and design details. This solution requires 0-10V enabled ballasts and drivers by others.

Visible System Components



Control Functionality

Occupant Enters:
All lights automatically turn on to maximum light level. Maximum light level is set to 80%.

Controlled receptacles automatically regain power when occupant enters.

When Occupied:
Automatic: Overhead lights dim/brighten based on daylight availability. There are two perimeter daylight zones.

Manual: Occupant uses wall dimmers to set desired light levels for all lights.

Occupant Exits:
All lights automatically turn off 15 minutes after all occupants exit the controlled zone.

50% of all receptacles automatically turn off 15 minutes after all occupants exit.

System Events:
Demand Response: All lights automatically dim 20% during demand response event.

Control Strategies

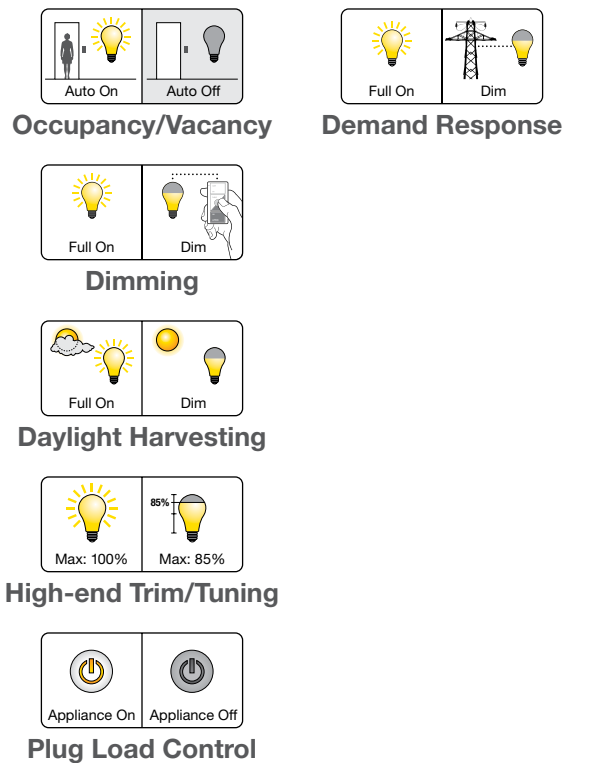

Lighting Energy Savings*

55%

* Go to lutron.com/references for more information.

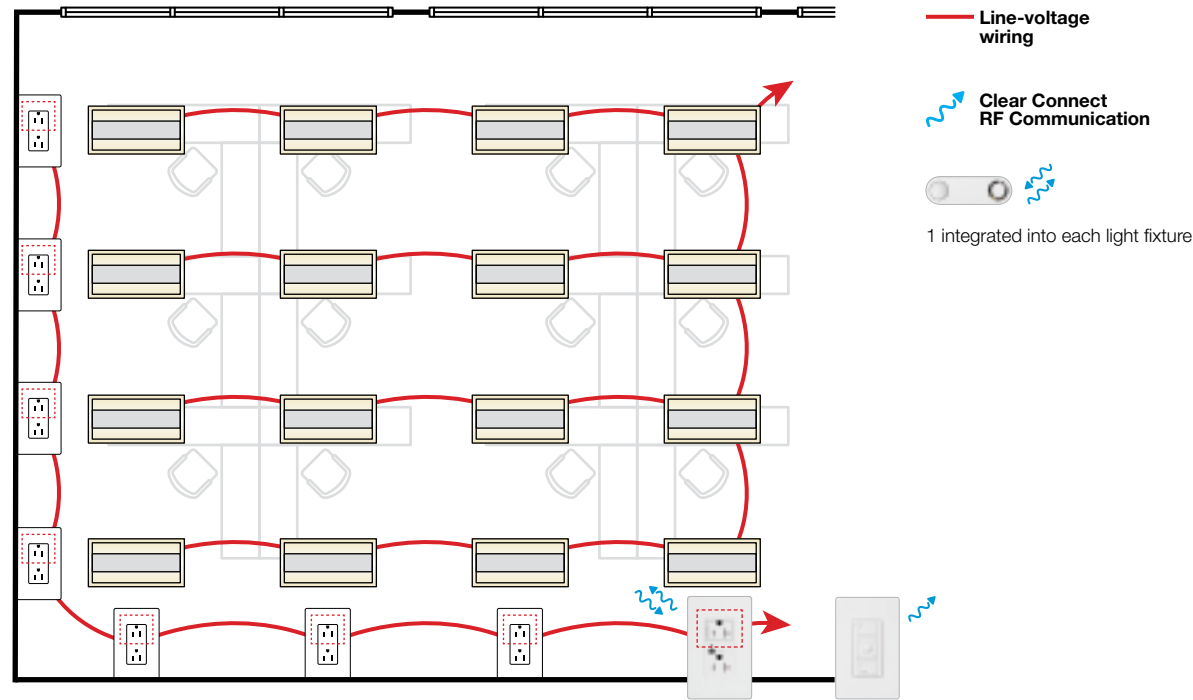

Symbol	Model Number	Description	Qty	List Price Each
	Integral to fixture ¹	Integral fixture control with sensor	16	\$ 78.00 ²
	CAR2S-20-STR-WH	Vive wireless receptacle	1	\$ 230.00
	PJ2-3BRL-GWH-L01	Pico wireless, 3-button with raise/lower control	1	\$ 27.00
	PICO-WBX-ADAPT	Pico wallbox adapter	1	\$ 9.50
	HJS-1-FM	Vive wireless hub	Shared	Consult your local rep for hub pricing and service options.

1 Fixture control comes pre-installed in fixture. Look for the Clear Connect Wireless symbol for fixtures containing this module. Go to lutron.com/findafixture for a complete list of compatible fixtures and drivers.
2 Fixture adder for the control module may vary.



This solution requires digitally enabled ballasts and drivers by others.

Visible System Components

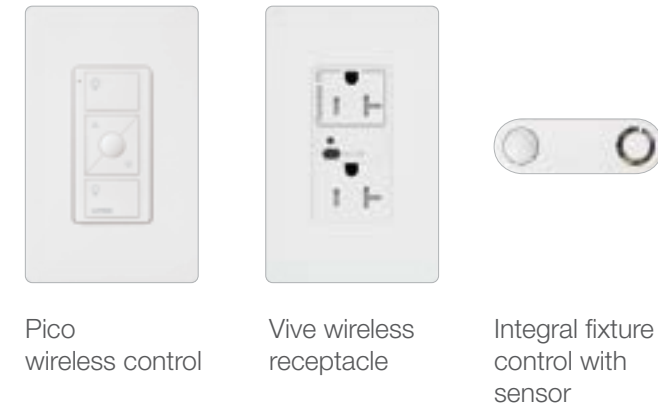

Control Functionality

Occupant Enters: Each individual light automatically turns on to 50% light level as occupant approaches fixture proximity.

Controlled receptacles automatically regain power when occupant enters.

When Occupied: Automatic: Each individual overhead light dims/brightens based on local daylight availability.

Manual: Occupant uses wall dimmer to set desired light levels for all lights. Maximum light level is set to 80%.

Occupant Exits: Each individual light automatically turns off 15 minutes after all occupants exit fixture proximity.

50% of all receptacles automatically turn off 15 minutes after all occupants exit.

System Events: Demand Response: All lights automatically dim 20% during demand events.

Control Strategies

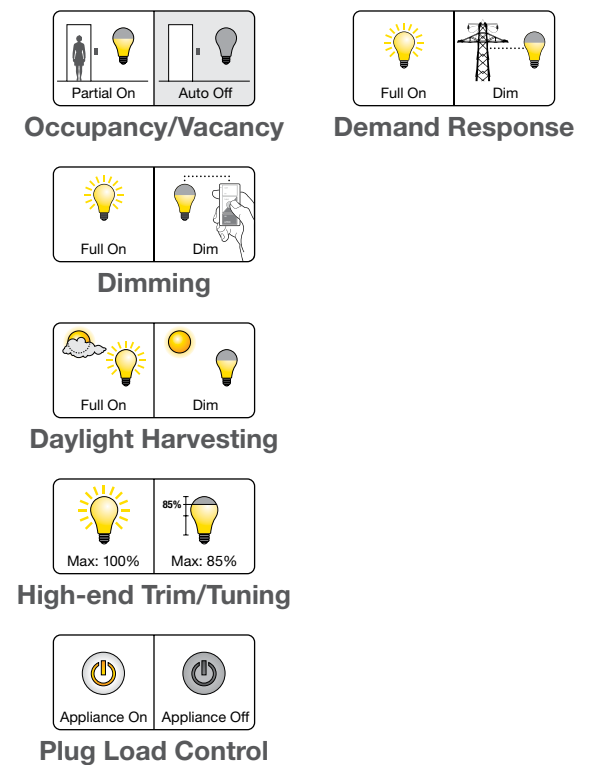



Lighting Energy Savings*

60%

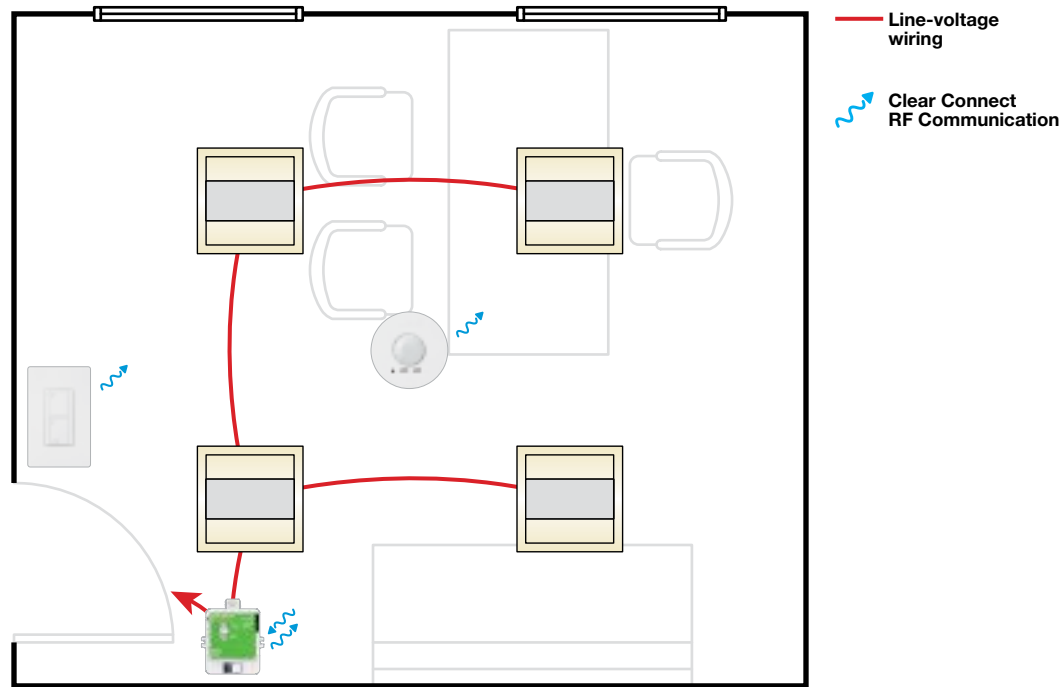
* Go to lutron.com/references for more information.



Symbol	Model Number	Description	Qty	List Price Each
	RMJS-16R-DV-B	PowPak switching module	1	\$ 155.00
	LRF2-VCR2B-P-WH	Radio Powr Savr wireless, ceiling-mount vacancy sensor	1	\$ 105.00
	PJ2-2B-GWH-L01	Pico wireless 2-button control	1	\$ 27.00
	PICO-WBX-ADAPT	Pico wallbox adapter	1	\$ 9.50

Code Notes: Retrofit requirements indicated are for lighting alterations which replace more than 10% of the number of luminaires in the space, and use less than 80% of the maximum allowed lighting power. Or, one-for-one luminaire replacements for buildings or tenant spaces less than 5,000 ft² when new lighting power is 40% lower than previous lighting power. Want to add a Vive wireless hub for more features? Go to lutron.com/vive for complete compatibility and design details.

Visible System Components



Pico wireless control



Radio Powr Savr wireless, ceiling-mount vacancy sensor

Control Functionality

Occupant Enters:

Lights do not automatically turn on when an occupant enters the space; lights must be turned on manually.

When Occupied:

Manual: Occupant uses wall switch to turn all lights off.

Occupant Exits:

All lights automatically turn off 15 minutes after all occupants exit.

Control Strategies

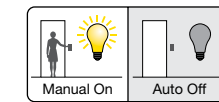

Occupancy/Vacancy

Lighting Energy Savings*

30%

* Go to lutron.com/references for more information.



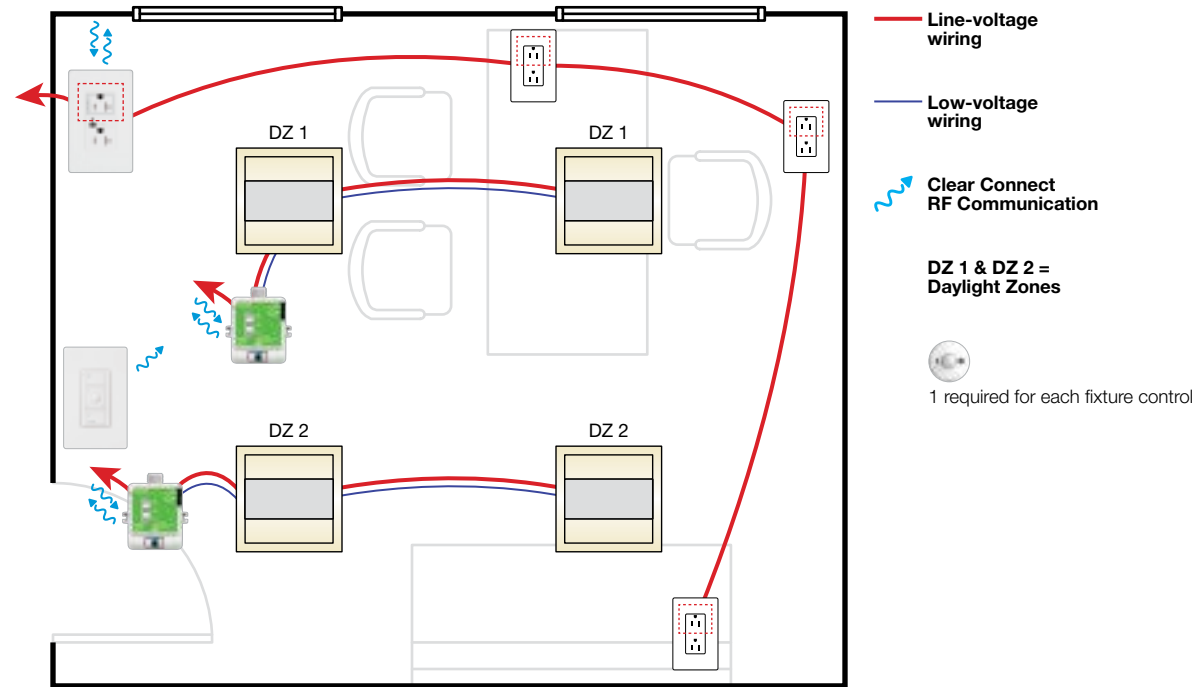

Symbol	Model Number	Description	Qty	List Price Each
	FCJS-010	Wireless fixture control with 0-10V	2	\$ 91.00
	CAR2S-20-STR-WH	Vive wireless receptacle	1	\$ 230.00
	FC-SENSOR	PowPak fixture sensor	2	\$ 40.50
	PJ2-3BRL-GWH-L01	Pico wireless, 3-button with raise/lower control	1	\$ 27.00
	PICO-WBX-ADAPT	Pico wallbox adapter	1	\$ 9.50
	HJS-1-FM	Vive wireless hub	Shared	Consult your local rep for hub pricing and service options.

FCJS models are capable of controlling up to 3 ballasts or drivers. Review the "Vive PowPak Fixture Controls" submittal document for more design details. Want to add a Vive wireless hub for more features? Go to lutron.com/vive for complete compatibility and design details. This solution requires 0-10V enabled ballasts and drivers by others.

Visible System Components

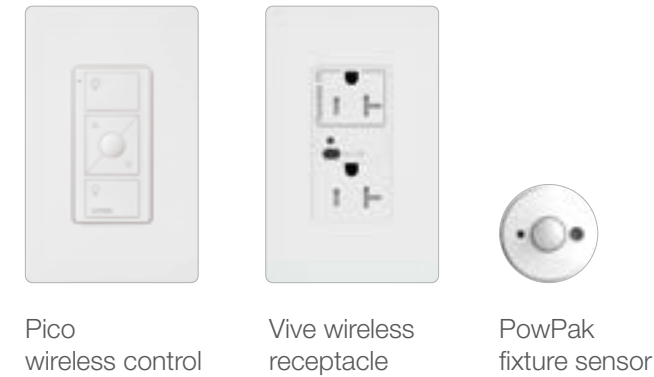

Control Functionality

Occupant Enters: Lights do not automatically turn on when an occupant enters the space; lights must be turned on manually. Maximum light level is set to 80%.

Controlled receptacles automatically regain power when occupant enters.

When Occupied: Automatic: Overhead lights dim/brighten based on daylight availability. There are two perimeter daylight zones.

Manual: Occupant uses wall dimmer to set desired light levels for all lights.

Occupant Exits: All lights automatically turn off 15 minutes after all occupants exit.

50% of all receptacles automatically turn off 15 minutes after all occupants exit.

System Events: Demand Response: All lights automatically dim 20% during demand events.



Control Strategies

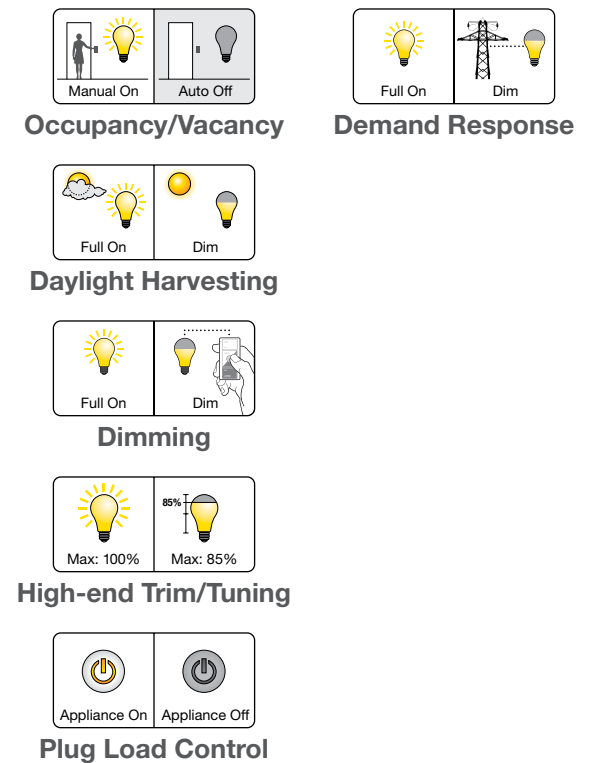

Lighting Energy Savings*

60%

* Go to lutron.com/references for more information.

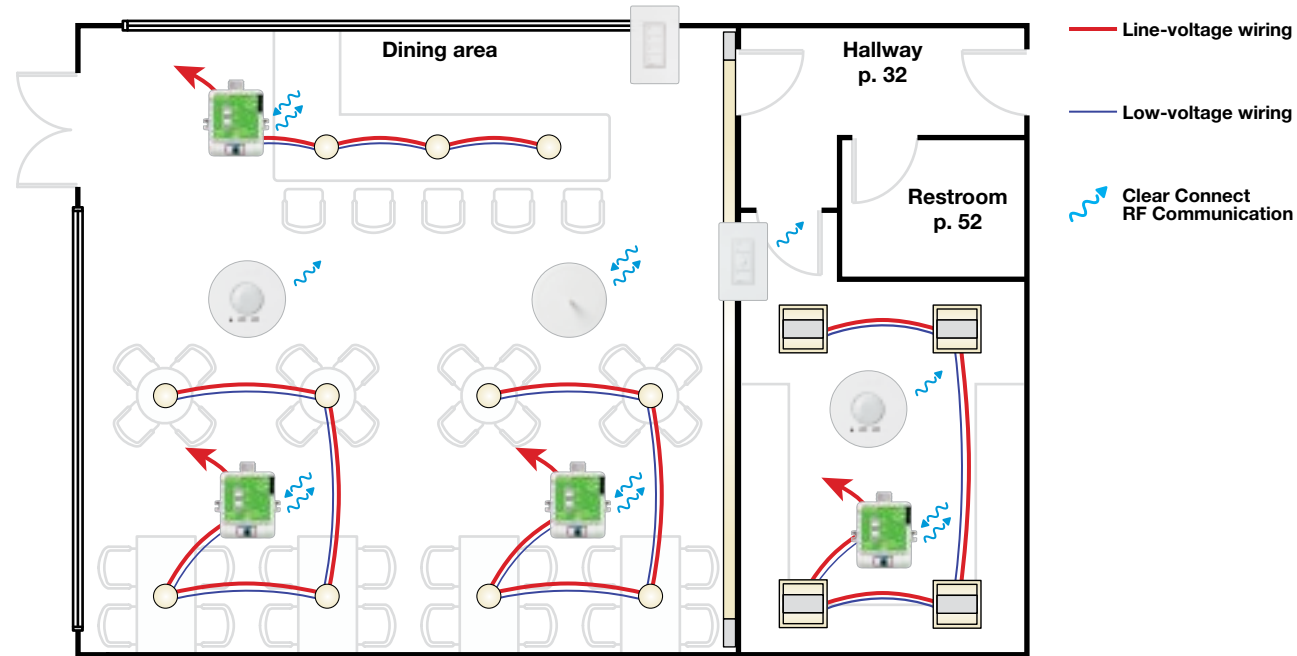

Symbol	Model Number	Description	Voltage	Qty	List Price Each
	RMJS-8T-DV-B	PowPak dimming module with 0-10V	120V/ 277V	4	\$ 180.00
	LRF2-OCR2B-P-WH	Radio Powr Savr wireless, ceiling-mount occupancy sensor	N/A	2	\$ 105.00
	PJ2-3BRL-GWH-L01	Pico wireless, 3-button with raise/lower control	N/A	1	\$ 27.00
	PICO-WBX-ADAPT	Pico wallbox adapter	N/A	1	\$ 9.50
	PJ2-4B-GWH-L31	Pico wireless, 4-button scene control	N/A	1	\$ 45.00
	PICO-WBX-ADAPT	Pico wallbox adapter	N/A	1	\$ 9.50
	HJS-0-FM	Vive wireless hub	N/A	Shared	Consult your local rep for hub pricing and service options.

Code Notes: Add a daylight sensor for restrooms with daylight zones. Go to lutron.com/vive for complete compatibility and design details. This solution requires 0-10V enabled ballasts and drivers by others.

Visible System Components



Pico wireless control



Radio Powr Savr wireless, ceiling-mount occupancy sensor



Vive wireless hub

Control Functionality

Prior to Business Opening:

Lights scheduled to automatically turn on in dining area prior to employee arrival.

Occupant Enters:

Lighting automatically turns on to at least 50% of full power in employee-only area. Remaining lighting must be turned on manually.

When Occupied:

Automatic: Lighting in dining area changes to different scenes for breakfast, lunch, and dinner.

Manual: Employees can use wall dimmers to adjust lighting as needed.

Occupant Exits:

All lights automatically turn off 15 minutes after all occupants exit the employee-only area.

After Business Closing:

All lighting in dining area is scheduled to automatically turn off after business operations conclude.

Control Strategies

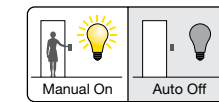

Occupancy/Vacancy

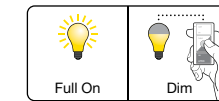

Dimming

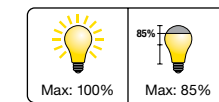

High-end Trim/Tuning

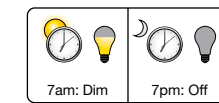

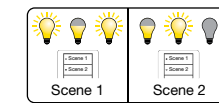

Scheduling

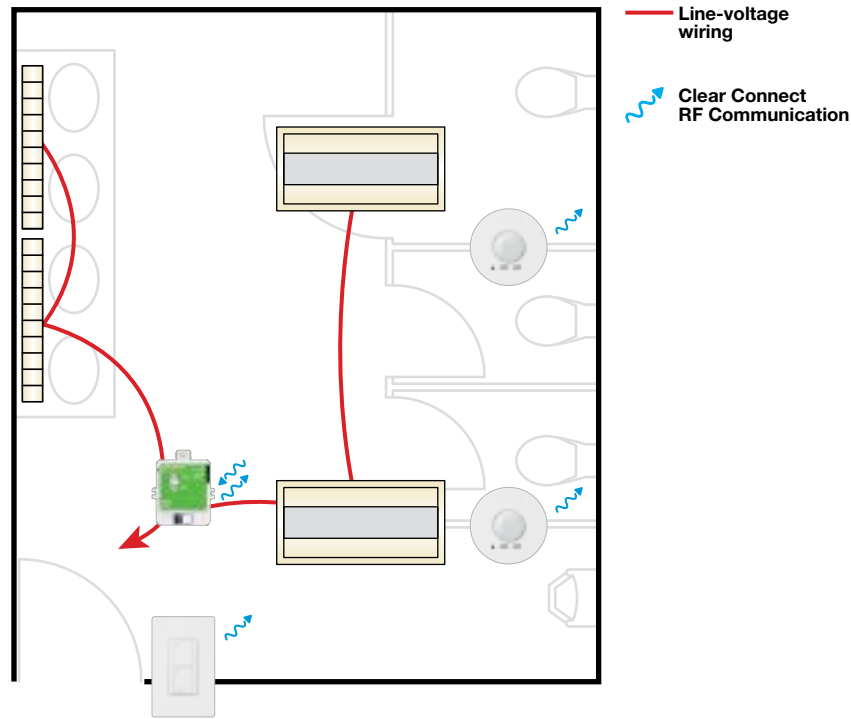

Scene Control



Symbol	Model Number	Description	Qty	List Price Each
	RMJS-16R-DV-B	PowPak switching module	1	\$ 155.00
	LRF2-OCR2B-P-WH	Radio Powr Savr wireless, ceiling-mount occupancy sensor	2	\$ 105.00
	PJ2-2B-GWH-L01	Pico wireless 2-button control	1	\$ 27.00
	PICO-WBX-ADAPT	Pico wallbox adapter	1	\$ 9.50

Code Notes: Retrofit requirements indicated are for lighting alterations which replace more than 10% of the number of luminaries in the space, and use less than 80% of the maximum allowed lighting power. Or one-for-one luminaire replacements for buildings or tenant spaces less than 5,000 ft² when new lighting power is 40% lower than previous lighting power. Local control may be not accessible to unauthorized personnel. Want to add a Vive wireless hub for more features? Go to lutron.com/vive for complete compatibility and design details.

Visible System Components



Pico wireless control



Radio Powr Savr wireless, ceiling-mount occupancy sensor

Control Functionality

Occupant Enters:

All lights automatically turn on to maximum light level.

When Occupied:

Manual: Occupant uses wall switch to turn all lights off.

Occupant Exits:

All lights automatically turn off 15 minutes after all occupants exit.

Control Strategies

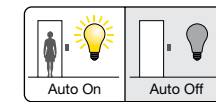

Occupancy/Vacancy

Lighting Energy Savings*

50%

* Go to lutron.com/references for more information.

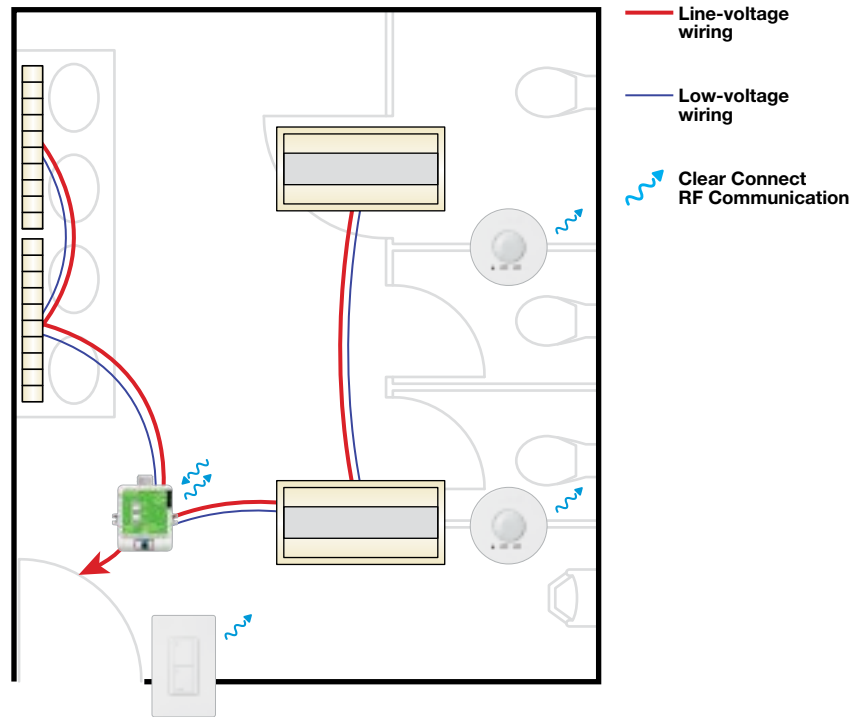

Symbol	Model Number	Description	Qty	List Price Each
	LRF2-OCR2B-P-WH	Radio Powr Savr wireless, ceiling-mount occupancy sensor	2	\$ 105.00
	PJ2-2B-GWH-L01	Pico wireless 2-button	1	\$ 27.00
	PICO-WBX-ADAPT	Pico wallbox adapter	1	\$ 9.50
	HJS-1-FM	Vive wireless hub	Shared	Consult your local rep for hub pricing and service options.

Code Notes: Add a daylight sensor for restrooms with daylight zones. Go to lutron.com/vive for complete compatibility and design details. This solution requires 0-10V enabled ballasts and drivers by others. Local control may be not accessible to unauthorized personnel.

Visible System Components



Pico wireless control



Radio Powr Savr wireless, ceiling-mount occupancy sensor

Control Functionality

Occupant Enters:

All lights automatically turn on to maximum light level. Maximum light level is set to 80%.

When Occupied:

Manual: Occupant uses wall switch to turn all lights off.

Occupant Exits:

All lights automatically turn off 15 minutes after all occupants exit.

System Events:

Demand Response: All lights automatically dim 20% during demand events.

Control Strategies

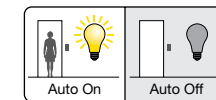

Occupancy/Vacancy

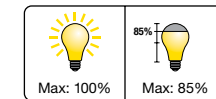

High-end Trim/Tuning

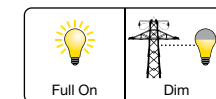

Demand Response

Lighting Energy Savings*

60%

* Go to lutron.com/references for more information.

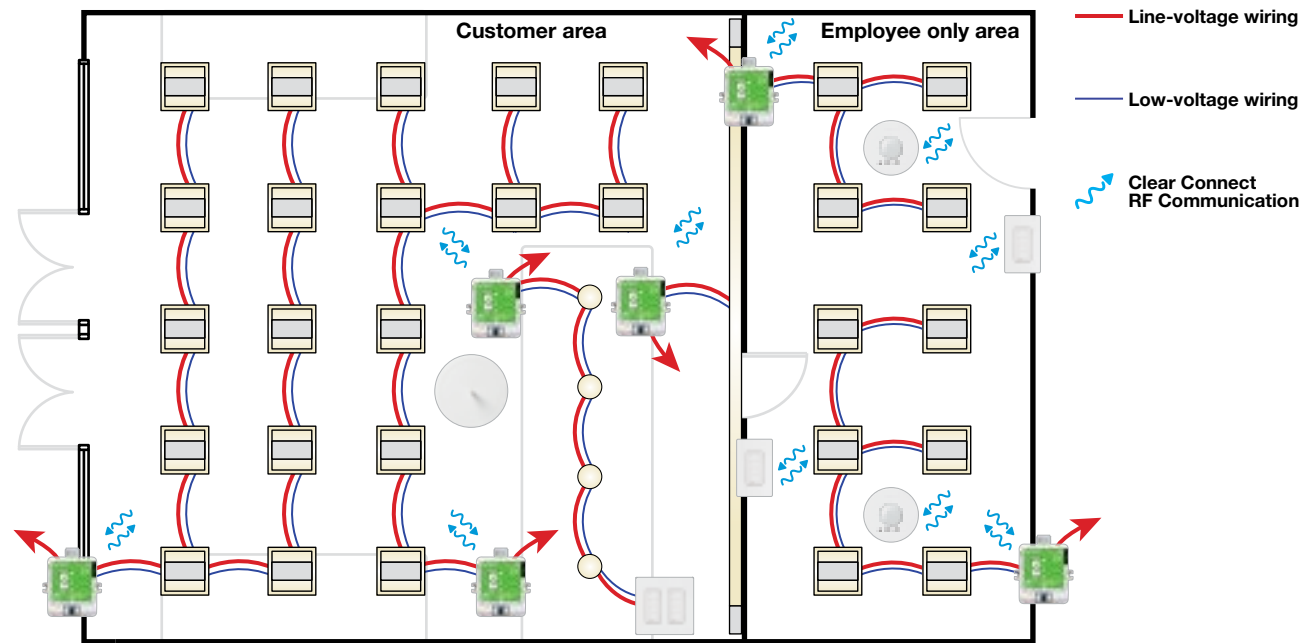

Symbol	Model Number	Description	Voltage	Qty	List Price Each
	RMJS-8T-DV-B	PowPak dimming module with 0-10V	120V/ 277V	6	\$ 180.00
	LRF2-OCR2B-P-WH	Radio Powr Savr wireless, ceiling-mount occupancy sensor	BATT	2	\$ 105.00
	PJ2-4B-GWH-L31	Pico wireless, 4-button scene control	N/A	4	\$ 45.00
	PICO-WBX-ADAPT	Pico wallbox adapter	N/A	4	\$ 9.50
	HJS-0-FM	Vive wireless hub	N/A	Shared	Consult your local rep for hub pricing and service options.

Code Notes: This solution requires 0-10V enabled ballasts and drivers by others. Go to lutron.com/vive for complete compatibility and design details.

Visible System Components



Pico wireless control



Radio Powr Savr wireless, ceiling-mount occupancy sensor



Vive wireless hub

Control Functionality

Prior to Business Opening:

Lights scheduled to automatically turn on in customer area prior to employee arrival.

Occupant Enters:

Lighting automatically turns on in employee-only area to at least 50% of full power. Remaining lighting must be turned on manually.

When Occupied:

Employee uses wall dimmer to set desired light levels for all lights.

Occupant Exits:

All lights automatically turn off 15 minutes after all occupants exit the employee-only area.

After Business Closing:

All lighting is scheduled to automatically turn off after business operations conclude.

Control Strategies

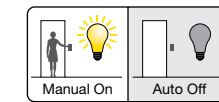

Occupancy/Vacancy

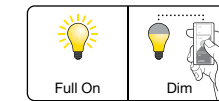

Dimming

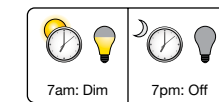

Scheduling

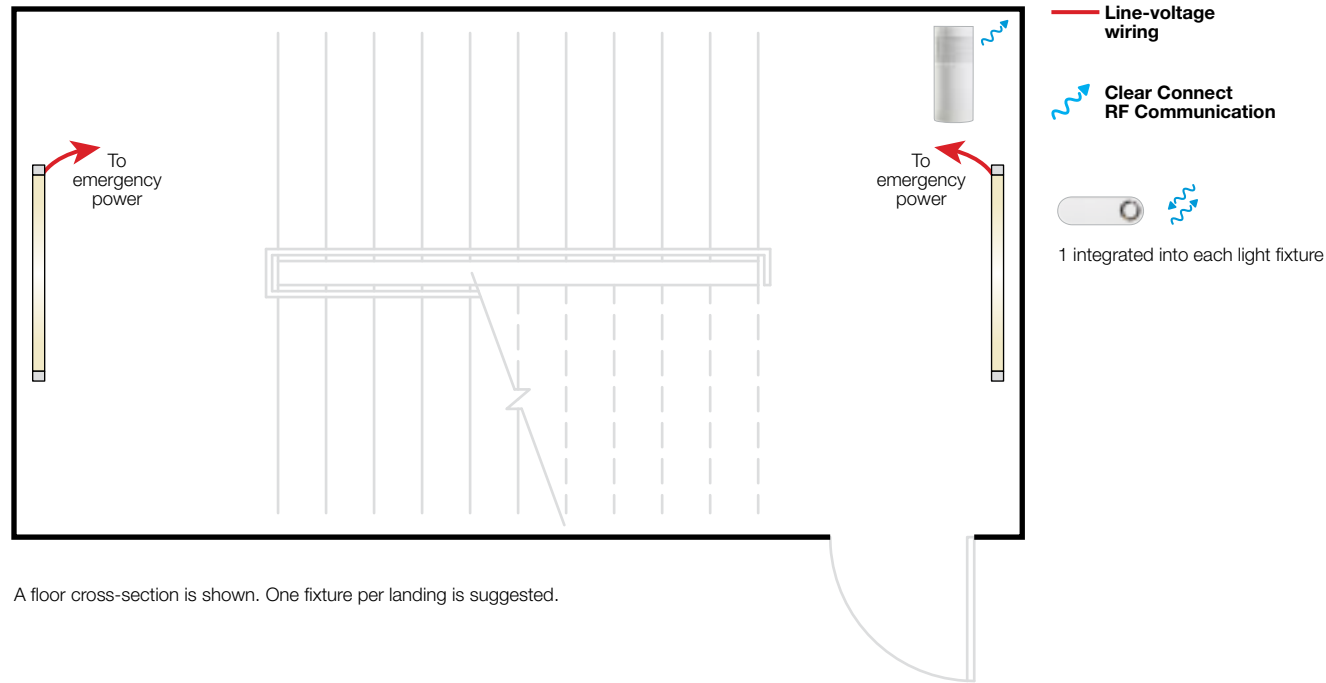

A floor cross-section is shown. One fixture per landing is suggested.

Symbol	Model Number	Description	Qty	List Price Each
	Integral to fixture ¹	Integral fixture control	2 (per floor)	\$ 67.00 ²
	LRF2-OKLB-P-WH	Radio Powr Savr wireless, corner-mount occupancy sensor	1 (per floor)	\$ 105.00
	HJS-1-FM	Vive wireless hub	Shared	Consult your local rep for hub pricing and service options.

1. Fixture control comes pre-installed in fixture. Look for the Clear Connect Wireless symbol for fixtures containing this module. Go to lutron.com/findafixture for a complete list of compatible fixtures and drivers.
2. Fixture adder for the control module may vary.



Visible System Components



Radio Powr Savr wireless, corner-mount occupancy sensor



Integral fixture control

Control Functionality

Occupant Enters:

All lights automatically turn on to maximum light level. Maximum light level is set to 80%.

Occupant Exits:

All lights dim to minimum light level 15 minutes after all occupants exit. Minimum light level is set to 10%.

Emergency Mode:

Lighting connected to emergency power turns on to full output.

System Events:

Demand Response: All lights automatically dim 20% during demand response event. Demand response cannot shut off the lights.

Control Strategies

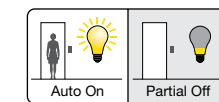

Occupancy/Vacancy

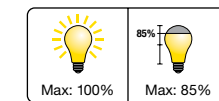

High-end Trim/Tuning

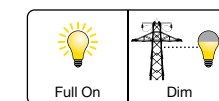

Demand Response

Lighting Energy Savings*

80%

* Go to lutron.com/references for more information.

Code Notes: Verify that the egress fixtures go to full output upon loss of control signal. For projects that require UL 924 compliance, provide an automatic load control relay (ALCR) per load controller connected to emergency fixtures. Add a daylight sensor for stairwells with daylight zones. This solution requires digitally enabled ballasts and drivers by others. Go to lutron.com/vive for the latest compatibility details. Up to 0.1 W per sq. ft. may be continuously illuminated for means of egress illumination. Local control may be not accessible to unauthorized personnel.

Code Notes: For non-egress stairwells, set the minimum light level to full off.

Lutron, the Lutron logo, Clear Connect, EcoSystem, Energi Savr Node, Hi-lume, Maestro, Pico, PowPak, Quantum, Radio Powr Savr, and Vive are trademarks or registered trademarks of Lutron Electronics Co., Inc., in the U.S. and/or other countries.

lutron.com

Lutron Electronics Co., Inc., 7200 Suter Road, Coopersburg, PA 18036-1299

Customer Assistance

Online: lutron.com/help

Email: support@lutron.com

Phone: 1.844.LUTRON1 (588.7661) — includes 24/7 technical support

© 08/2022 Lutron Electronics Co., Inc. | P/N 368-6165 REV A

