



# 2022

## SINGLE-FAMILY RESIDENTIAL COMPLIANCE MANUAL

FOR THE 2022 BUILDING ENERGY  
EFFICIENCY STANDARDS

TITLE 24, PART 6, AND  
ASSOCIATED ADMINISTRATIVE  
REGULATIONS IN PART 1



Published: MAY 2022

Revised: MAY 2023  
CEC-400-2022-006-CMF-REV

CALIFORNIA ENERGY COMMISSION  
Gavin Newsom, Governor

# CALIFORNIA ENERGY COMMISSION

David Hochschild

**Chair**

Siva Gunda

**Vice Chair**

J. Andrew McAllister, Ph.D.

Patty Monahan

Kourtney Vaccaro

**Commissioners**

Bach Tsan, P.E.

Payam Bozorgchami, P.E.

**Project Managers**

Will Vicent

**Manager**

**BUILDING STANDARDS OFFICE**

Michael J. Sokol

**Deputy Director**

**EFFICIENCY DIVISION**

Drew Bohan

**Executive Director**

## DISCLAIMER

**Staff members of the California Energy Commission (CEC) prepared this report manual, which is intended to provide guidance on how to comply with the 2022 Building Energy Efficiency Standards. However, use of or compliance with the guidance does not assure compliance with the 2022 Building Energy Efficiency Standards and it is the responsibility of the user of this document to ensure compliance with the 2022 Building Energy Efficiency Standards and all other applicable laws and regulations. The CEC, the State of California, its employees, contractors, and subcontractors make no warrant, express or implied, and assume no legal liability regarding the use of this manual; nor does any party represent that the uses of this information will not infringe upon privately owned rights. This report has not been approved or**

**disapproved by the CEC nor has the Commission passed upon the accuracy or adequacy of the information in this report.. As such, it does not necessarily represent the views of the California Energy Commission, its employees, or the State of California. The California Energy Commission, the State of California, its employees, contractors, and subcontractors make no warrant, express or implied, and assume no legal liability for the information in this report; nor does any party represent that the uses of this information will not infringe upon privately owned rights. This report has not been approved or disapproved by the California Energy Commission nor has the Commission passed upon the accuracy or adequacy of the information in this report.**

## **ACKNOWLEDGMENTS**

The Building Energy Efficiency Standards (Energy Standards) were adopted and put into effect in 1978, and have been updated periodically in the intervening years. The Energy Standards are a unique California asset that have placed the state on the forefront of energy efficiency, sustainability, energy independence, and climate change issues. These standards also have provided a template for national standards within the United States, as well as for other countries around the globe. They have benefitted from the conscientious involvement and enduring commitment to the public good of many persons and organizations along the way. The 2022 Energy Standards development and adoption process continues a longstanding practice of maintaining the standards with technical rigor, challenging but achievable design and construction practices, public engagement, and full consideration of the views of stakeholders.

The 2022 Energy Standards revision and the supporting documents were conceptualized, evaluated, and justified through the excellent work of California Energy Commission (CEC) staff and consultants working under contract to the CEC, supported by the utility-organized Codes and Standards Enhancement (CASE) Initiative, and shaped by the participation of more than 150 stakeholders and the contribution of more than 1,300 formal public comments.

The authors would like to acknowledge the following staff and leaders:

**Leadership** — Commissioner Andrew McAllister and his advisor, Bill Pennington, for unwavering leadership throughout the standards development process; Payam Bozorgchami, P.E., senior engineer and overall project manager; Maziar Shirakh, P.E., senior engineer and building decarbonization lead; Haile Bucaneg, senior engineer and lead for mechanical measures; Javier Perez, senior specialist and lead for multifamily measures; Peter Strait, supervisor of the Standards Development Unit and interim acting manager of the Building Standards Office; Che Geiser, supervisor of the

Standards Tools Unit; Chris Olvera, supervisor of the Outreach and Education Unit; and Will Vicent, manager of the Building Standards Office.

**Legal Counsel** — Under the leadership of the chief counsel, Linda Barrera, the following staff provided legal counsel: James Qaqundah, Matt Chalmers, Michael Murza, Josephine Crosby, Justin Delacruz, and Chester Hong.

**Efficiency Division staff** — In the Building Standards Office: Thao Chau, P.E.; Cheng Moua, P.E.; Simon Lee, P.E.; Jeff Miller, P.E.; Ronald Balneg; Danuta Drozdowicz, Michael Shewmaker; Danny Tam; RJ Wichert; Haider Alhabibi; Muhammed Saeed; Amie Brousseau; Erik Jensen, Gagandeep Randhawa, and Allen Wong. In the Standards Compliance Office: Lorraine White, Charles Opferman, Ronnie Raxter, Samuel Cantrell, Javier Flores, Joe Loyer; Matthew Haro, P.E.; Armando Ramirez; Judy Roberson; and Daniel Wong, P.E. The following staff provided administrative support and editing: Christine Collopy; Corrine Fishman; Amber Beck; Hilary Fiese, Michi Mason; and Tajanee Ford-Whelan.

**Energy Commission Consultants** — Key consultants include NORESKO, Bruce Wilcox, the California Statewide Codes and Standards Program – which is funded by California utility customers and administered by Pacific Gas and Electric Company, Southern California Edison Company, San Diego Gas & Electric Company, Los Angeles Department of Water and Power, and Sacramento Municipal Utility District, under the auspices of the California Public Utilities Commission – and their consultants. The authors would also like to acknowledge the California Energy Alliance for the submission of its code change proposal relating to lighting in existing buildings. Key CEC and CASE consultants included NORESKO, Bruce Wilcox, Frontier Energy, McHugh Energy, Energy Solutions. The CASE Initiative is supported by a consortium of California utility providers that includes the Pacific Gas and Electric Company, Southern California Edison Company, San Diego Gas & Electric Company, the Sacramento Municipal Utility District, and the Los Angeles Department of Water and Power.

## ABSTRACT

California's Building Energy Efficiency Standards were adopted in 1976 and have been updated periodically as directed by statute. In 1975, the Department of Housing and Community Development adopted rudimentary energy conservation standards under State Housing Law authority that were a precursor to the first generation of the standards. However, the Warren-Alquist Act<sup>1</sup> was passed one year earlier with explicit direction to the California Energy Commission (CEC), formally titled the State Energy Resources Conservation and Development Commission, to adopt and implement the standards. The CEC's statute created separate authority and specific direction regarding what the standards are to address, what criteria are to be met in developing the Standards, and what implementation tools, aids, and technical assistance are provided.

The standards contain energy and water efficiency requirements (and indoor air quality requirements) for newly constructed buildings, additions to existing buildings, and alterations to existing buildings. Public Resources Code Sections 25402 subdivisions (a)-(b) and 25402.1 emphasize the importance of building design and construction flexibility by requiring the CEC to establish performance standards, in the form of an "energy budget" in terms of the energy consumption per square foot of floor space.

Public Resources Code Section 25402.1 requires the CEC to support the performance standards with compliance tools for builders and building designers. The Alternative Calculation Method (ACM) Approval Manual adopted by regulation as an appendix of the Standards establishes requirements for input, output and calculational uniformity in the computer programs used to demonstrate compliance with the Standards. The CEC develops and makes publicly available free, public domain building modeling software to enable compliance based on modeling of building efficiency and performance. The ACM Approval Manual also includes provisions for private firms seeking to develop compliance software for approval by the CEC, which further encourages flexibility and innovation.

---

<sup>1</sup> [Warren-Alquist Act 2022 Edition](#)

**Keywords:**

California Energy Commission	mandatory	envelope insulation
California Building Code	prescriptive	HVAC
California Building Energy Efficiency Standards	performance time-dependent	building commissioning process load
Title 24, Part 6	valuation	refrigeration
2022 Building Energy Efficiency Standards	TDV ducts in conditioned spaces	data center exhaust
Residential	high-performance attics	compressed air
Nonresidential	high-performance walls	acceptance testing
newly constructed	high-efficacy lighting	data collection
additions and alterations to existing buildings	water heating windows	cool roof on-site renewable

# LINKS TO CHAPTERS

## Links to Chapters

Chapter 1 .....	Introduction
Chapter 2 .....	Compliance and Enforcement
Chapter 3 .....	Building Envelope
Chapter 4 .....	Building HVAC
Chapter 5 .....	Water Heating
Chapter 6 .....	Lighting
Chapter 7 .....	PV, Battery Storage, and Solar Ready
Chapter 8 .....	Performance Method
Chapter 9 .....	Additions, Alterations, and Repairs
Chapter 10.....	Electric Ready
Appendix A .....	Compliance Documents
Appendix B .....	Climate Zones
Appendix C .....	Reserved
Appendix D .....	Eligibility Criteria for Radiant Barriers
Appendix E .....	Natural Gas Appliance Testing Standards
Appendix F .....	Field Verified Zonally Controlled Systems
Appendix G .....	Verification of Existing Home Features
Appendix H .....	Demand Responsive Controls

## **EXECUTIVE SUMMARY**

The Compliance Manuals are intended to help plans examiners, inspectors, owners, designers, builders, and energy consultants comply with and enforce California's *2022 Building Energy Efficiency Standards*. These manuals contain information supplemental to the code regulations themselves and contain copies of compliance documents ("forms") used to demonstrate compliance. There are two compliance manuals: one for single-family homes and a second one for nonresidential building and multifamily homes.



## Table of Contents

Introduction	1
1.1 Related Documents	1
1.2 The Technical Chapters	2
1.3 Why California Needs Building Energy Efficiency Standards	3
1.3.1 Energy Savings	3
1.3.2 Electricity Reliability and Demand	4
1.3.3 Comfort	4
1.3.4 Economics	4
1.3.5 Environment	4
1.3.6 Global Warming	4
1.3.7 Building Decarbonization	5
1.3.8 The Warren-Alquist Act	6
1.4 What’s New for 2022	6
1.4.1 Summary of Changes for Residential Buildings Include:	6
1.5 Scope and Application	9
1.5.1 Building Types	9
1.5.2 Explanation of Terms	12
1.5.3 Building Orientation	13
1.5.4 Historical Buildings	13
1.5.5 Buildings Not Required to Meet Prescriptive and Performance Standards	15
1.5.6 Building Systems Covered	16
1.5.7 Additions, Alterations, and Repairs	16
1.6 Compliance Approaches and Mandatory Requirements	20
1.6.1 Approaches	20
1.6.2 Mandatory Requirements	21
1.6.3 Prescriptive Approach	21
1.6.4 Performance Approach	22
1.7 Climate Zones	22
1.7.1 Building Location Data	24
1.8 Conditioned Floor Area	25

1.9	Where to Get Help	26
1.9.1	Energy Commission Publications and Support	26
1.9.2	Telephone Hotline	26
1.9.3	Training Opportunities	28
1.9.4	Energy Consultants	28
1.9.5	Online Videos	29
1.9.6	HERS Raters and Providers	29

# Introduction

This compliance manual is intended to help plans examiners, inspectors, owners, designers, builders, and energy consultants comply with and enforce California’s 2022 Building Energy Efficiency Standards (Energy Code) for single-family residential buildings. The lighting, domestic hot water, and indoor air quality requirements in this compliance manual also apply to low-rise multifamily buildings, three stories or less. The manual is written as a reference and instructional guide and can be helpful for anyone that is directly or indirectly involved in the design and construction of energy-efficient single-family residential buildings.

The compliance manual has 10 chapters:

**Chapter 1** introduces the Energy Code and discusses the application and scope of the standards for single-family residences.

**Chapter 2** analyzes the compliance and enforcement process, including design and preparation of compliance documentation through field verification and diagnostic testing.

**Chapter 3** details the building envelope.

**Chapter 4** discusses heating, ventilation, and air-conditioning (HVAC) systems.

**Chapter 5** outlines water-heating systems requirements, including the requirements for swimming pool systems.

**Chapter 6** looks at requirements for hardwired interior lighting and for outdoor lighting permanently attached to the building.

**Chapter 7** examines photovoltaics, battery storage systems, and shared solar electric systems or community-shared battery system compliance option and solar-ready requirements for single-family residential buildings.

**Chapter 8** outlines the performance approach to compliance.

**Chapter 9** goes over additions, alterations, and repairs.

**Chapter 10** covers the mandatory electric readiness requirements for mixed-fuel single-family buildings.

---

## 1.1 Related Documents

This compliance manual supplements four other related documents that are available from the California Energy Commission. These are:

- A. *The 2022 Building Energy Efficiency Standards, Title 24, Part 6* (Energy Code). This compliance manual supplements and explains and clarifies California’s energy efficiency standards for buildings; it does not replace them. Readers should have a copy of the Energy Code to refer to while reading this manual, as well as a copy of the *2022 Reference Appendices*.

- B. 2022 Reference Appendices — The reference appendices have three main subsections: Reference Joint Appendices, Reference Residential Appendices, and Reference Nonresidential Appendices:
1. *The 2022 Reference Joint Appendices* contain information common to single-family residential, nonresidential, and multifamily buildings including, but not limited to, definitions, climate zone information, weather data, assembly properties, qualification requirements for high-efficacy light sources, compliance documentation registration procedures, qualification requirements for photovoltaic systems, and qualification requirements for battery storage systems.
  2. The *2022 Reference Residential Appendices* contain information for single-family residential and low-rise multifamily buildings. The Reference Residential Appendices contain Home Energy Rating System (HERS) field verification and diagnostic testing procedures for HVAC equipment, air distribution ducts, and quality insulation installation.
  3. The *2022 Reference Nonresidential Appendices* contain information for both nonresidential and high-rise multifamily buildings. The reference nonresidential appendices contain HERS field verification and diagnostic testing procedures for HVAC equipment and air distribution ducts, acceptance testing procedures, and luminaire power default values.
- C. The 2022 Residential Alternative Calculation Method (ACMs or Compliance Software) Approval Manual. The 2022 Residential ACM Approval Manual describes the process for certifying and decertifying the compliance software programs.
- D. *The 2022 Residential Alternative Calculation Method Reference Manual* lays out the technical rules for implementing the 2022 performance compliance path in software programs.

Material from related documents is not repeated in this compliance manual; rather, it is referenced. If you are using the electronic version of this compliance manual, there are hyperlinks throughout the manual that will take you directly to the document that is referenced.

---

## 1.2 The Technical Chapters

Each of the technical chapters (Chapters 3 through 10) begins with an overview, followed by a presentation of a specific topic in each subsection. For the building envelope, subsections include fenestration, opaque surfaces (walls, floors, and roofs), air leakage and infiltration, radiant barriers, cool roofs, and quality insulation installation (QII) verification. For HVAC, the subsections include heating equipment, cooling equipment, air distribution and fans, controls, indoor air quality, alternative systems, refrigerant charge, and verification. For water heating, subsections include equipment efficiencies and distribution systems. Lighting subsections include high-

efficacy lighting, light-emitting diode (LED) lighting, switching devices and controls, and recessed luminaires. Mandatory requirements and prescriptive requirements (defined in Section 1.6 of this chapter) are described within each subsection or component. For photovoltaics (PV), the subsections include qualification requirements for photovoltaic systems, battery storage systems, shared solar electric system, or community-shared battery system compliance option and solar-ready requirements for low-rise residential buildings. Chapter 8 describes the computer performance approach. Chapter 9 covers requirements for additions and alterations. Chapter 10 outlines the mandatory electric readiness requirements for single-family buildings when mixed-fuel space heating, water heating, cooking and clothes drying is used. Chapter 2, although not a technical chapter, covers important compliance and enforcement topics.

Each technical chapter or subsection also has a compliance options section. The compliance options section includes information on how to design a building that goes beyond the prescriptive energy efficiency requirements and mandatory energy efficiency requirements. Compliance options are used for compliance credit through the performance approach. There are also design recommendations for which no compliance credit is offered. However, following the recommendations will significantly impact building energy use or peak demand.

**Table 1-1: Compliance Options vs. Design Recommendations**

<b>Compliance Options</b>	<b>Design Recommendations, such as interior fenestration shading devices</b>
Credit offered through the performance approach	No credit but may still affect energy or demand.

Source: California Energy Commission

## **1.3 Why California Needs Building Energy Efficiency Standards**

Energy efficiency reduces energy costs, increases reliability and availability of electricity, improves building occupant comfort, and reduces impacts to the environment, making the Energy Code important and necessary for California’s energy future.

### **1.3.1 Energy Savings**

Reducing energy use benefits everyone. Homeowners save money, Californians have a more secure and healthy economy, the environment is less negatively impacted, and the state electrical system can operate in a more stable manner. The 2022 Energy Code (for residential and nonresidential buildings) are expected to reduce the growth in electricity use and natural gas use.

### **1.3.2 Electricity Reliability and Demand**

Buildings are one of the major contributors to electricity demand. During the 2000–2001 California electricity crisis and the East Coast blackout in the summer of 2003, California Energy Commission (CEC) staff learned that the electric distribution network is fragile and system overloads caused by excessive demand from buildings can create unstable conditions. Furthermore, resulting blackouts can seriously disrupt business and cost the economy billions of dollars.

Since the California electricity crisis, the CEC has placed increasing emphasis on demand reduction.

### **1.3.3 Comfort**

Comfort is an important benefit of energy-efficient homes. Energy-efficient houses are well-insulated, are less drafty, and use high-performance windows or shading or both to reduce solar gains and heat loss. Poorly designed building envelopes result in less comfortable homes. Even with oversized heating and cooling systems, comfort cannot be achieved in older, poorly insulated, and leaky homes.

### **1.3.4 Economics**

For the homeowner, energy efficiency helps ensure that a home is affordable now and into the future. Banks and other financial institutions recognize the effect of energy efficiency through energy-efficient mortgages; they look at the total cost of owning the home, including paying the utility bills. If the utility bills are lower, lenders can qualify borrowers for a larger loan.

From a larger perspective, the less California depends on depletable fossil resources such as natural gas, coal, and oil, the stronger and more stable the economy will remain in the face of energy cost increases. A cost-effective investment in energy efficiency helps everyone. In many ways, it is far more cost-effective for the people of California to invest in saving energy than it is to invest in building new power plants.

### **1.3.5 Environment**

In many parts of the world, energy use has led to oil spills, acid rain, smog, and other forms of environmental pollution that have ruined the natural beauty people seek to enjoy. California is not immune to these problems, but appliance standards, building standards, and utility programs that promote efficiency and conservation help maintain environmental quality. Other benefits include reduced destruction of natural habitats, which helps protect animals, plants, and natural systems.

### **1.3.6 Global Warming**

Burning fossil fuels contributes greatly to global warming; carbon dioxide is being added to an atmosphere already containing 35 percent more than it did two centuries ago. Carbon dioxide and other greenhouse gases create an insulating layer around the Earth that leads to global climate change. CEC research shows that most

sectors of the state economy face significant risk from climate change, including water resources (from reduced snowpack), agriculture, forests, and the natural habitats of several indigenous plants and animals.

Scientists recommend that actions be taken to reduce emissions of carbon dioxide and other greenhouse gases. While adding scrubbers to power plants and catalytic converters to cars reduces other emissions, they do not limit the carbon dioxide emitted into the atmosphere. Using energy efficiently is a far-reaching strategy that can make an important contribution to reducing greenhouse gases.

The National Academy of Sciences has urged the United States to follow California's lead on such efforts, saying that conservation and efficiency should be the chief element in energy and global warming policy. Its first efficiency recommendation was simple: Adopt nationwide energy-efficient building codes. Energy conservation will not only increase comfort levels and save homeowners money, but it will also play a vital role in creating and maintaining a healthy environment.

The Energy Code is expected to have a significant impact on reducing greenhouse gas and other air emissions. Carbon dioxide (CO<sub>2</sub>), one of the more prevalent greenhouse gases, would be reduced.

### **1.3.7 Building Decarbonization**

California has nearly 14 million homes and 7.5 million square feet of commercial buildings. These buildings produce a quarter of the state's greenhouse gas (GHG) emissions, making homes and businesses a major factor in climate change. Reducing these emissions, also referred to as building decarbonization, is a key part of California's climate strategy.<sup>1</sup> Of the many tools in the state's building decarbonization toolbox, the Building Energy Efficiency Standards stand out as a proven solution of significance.

In August 2021, the CEC adopted the 2022 Energy Code for newly constructed and renovated buildings. This code blazes a trail for states and governments seeking to decarbonize the building sector aggressively, feasibly and cost-effectively. This update encourages efficient electric heat pumps, establishes electric-ready requirements for new homes, and strengthens ventilation standards. For the first time in the nation, this update also requires solar photovoltaic systems plus battery systems as the performance standards baseline for select nonresidential building types. Over the next 30 years, this code is estimated to provide the state with \$1.5 billion in environmental benefits; equivalent to taking nearly 2.2 million cars off the road for a year. The development of this code was a multiyear effort led by the CEC through a robust public process and with support from an

---

<sup>1</sup> AB3232, <https://www.energy.ca.gov/media/5968>

expansive network of key market partners such as California's largest utilities, the building community, and environmental advocates.<sup>2</sup>

### 1.3.8 The Warren-Alquist Act

#### *Section 25402 of the Public Resources Code*

Section 25402 of the California Public Resources Code (the code) authorizes the CEC to develop and maintain the Energy Code for new buildings. This section of the code, commonly referred to as the Warren-Alquist Act (the act), is direction from the Legislature on the development of the Energy Code in California.

The act created the CEC in 1974 and gave it authority to develop and maintain building energy efficiency standards for new buildings. The act directs the CEC to "prescribe, by regulation, lighting, insulation, climate control system, and other building design and construction standards which increase the efficiency in the use of energy for new residential and new nonresidential buildings." Additionally the act states that the "standards shall be performance standards and shall be promulgated in terms of energy consumption per gross square foot of floorspace, but may also include devices, systems, and techniques required to conserve energy and water."

The act also requires that the Energy Code be cost-effective "when taken in their entirety and amortized over the economic life of the structure," and it requires that the CEC periodically update the standards and develop manuals to support them. The act directs local building permit jurisdictions to withhold permits until the building satisfies the Energy Code.

---

## 1.4 What's New for 2022

The most significant change in the *2022 Building Energy Efficiency Standards* affecting single-family residential buildings is the change to a single fuel baseline with heat pump being prescriptively required for either water heating or space heating, depending on the climate zone. A new Energy Design Rating (EDR) metric, EDR1, was added that is based on hourly source energy. There are numerous new requirements for additions and alterations. There are also significant changes in requirements related to indoor air quality.

### 1.4.1 Summary of Changes for Residential Buildings Include:

#### A. Mandatory Requirements:

1. Mandatory roof deck insulation in newly constructed attic systems in Climate Zones 4 and 8–16 to meet an area-weighted average U-factor no greater than 0.184 (§150.0[a]1).

---

<sup>2</sup> 2022 code adoption script, <https://www.energy.ca.gov/event/meeting/2021-08/energy-commission-business-meeting>



2. Ducts in conditioned space can be uninsulated if specific conditions are met as explained in Section 4.4.1 (§150.0[m]1B).
  3. Electric readiness is now required for space heating, cooking, and clothes dryers when gas equipment is installed. Electrical infrastructure must be provided to the equipment location for the future installation of electrical appliances. (§150.0[t]-[v]).
  4. The electric-ready requirements for gas water heaters have been revised (§150.0[n]).
  5. Updated mechanical ventilation requirements based on the 2019 version of ASHRAE 62.2 (§150.0[o]).
  6. New requirements for central fan integrated ventilation systems requiring a motorized controlled damper (§150.0[o]1B).
  7. Updated local exhaust requirements for kitchen range hoods. Gas ranges require higher ventilation rates or capture efficiencies than electric ranges. (§150.0[o]1G).
  8. Simplify the hot water piping language and align with the Plumbing Code (§150.0[j]).
  9. Updated HPWH-ready requirements for gas water heater installations that include providing a designated space for a future HPWH installation. (See Electric Readiness — Chapter 10.)
  10. New battery storage-ready infrastructure requirements. (§150.0[s]).
- B. Prescriptive Compliance:
1. Under the prescriptive compliance approach, the heating equipment is required to be a heat pump in Climate Zones 3, 4, 13, and 14. In other climate zones, it can be either a heat pump or a gas heating system (§150.1[c]6).
  2. Under the prescriptive compliance approach, water heating equipment is required to be a heat pump water heater or a solar water heating system with electric backup and minimum 70 percent solar fraction. In Climate Zones 3, 4, 13, and 14 a gas instantaneous water heater is allowed (§150.1[c]8).
- C. Performance Compliance:
1. All compliance software programs approved by the CEC use the same compliance engine as the public domain software. The technical details and information about how the energy budget is determined are included in the 2022 Single-Family Residential Buildings Alternative Compliance Manual (ACM) Reference Manual.
  2. A new Energy Design Rating (EDR) metric, EDR1, was added that is based

on hourly source energy. What was referred to as just "Efficiency EDR" in the 2019 code is now efficiency EDR2.

D. Compliance requires meeting three components of an Energy Design Rating (EDR): (1) EDR (source), (2) Efficiency EDR2, and (3) Total EDR2 (§150.1(b)1). For more information, see Chapter 8.

E. Additions and Alterations:

1. An exception was added that not require junior accessory dwelling units (JADUs) that are classified as additions to an existing building to meet the whole-building mechanical ventilation requirements. JADUs are dwelling units that are no more than 500 square feet and contained entirely within an existing single-family building,
2. New language clarifying when mechanical ventilation requirements apply to alterations.
3. Ceiling insulation in additions 700 square feet or less must meet R-38 in Climate Zones 1, 2, 4, and 8–16 and R-30 in Climate Zones 3 and 5–7.
4. Expand the cool roof requirements for steep-sloped roof replacements to Climate Zones 4 and 8–9. The allowable exceptions were also revised.
5. Expand the cool roof requirements for low-sloped roof replacements to Climate Zones 4, 6–12, and 14. The allowable exceptions were also revised.
6. Add a new requirement for roof deck insulation for low-sloped roof replacements in Climate Zones 1, 2, 4, and 8–16. R-14 continuous roof deck insulation or and equivalent assembly roof assembly U-factor of 0.039 is required. Various exceptions to this requirement are allowed.
7. New language modifying when replacement electric resistance space heating equipment is allowed.
8. Reduce the duct sealing target for altered duct- and space-conditioning systems from 15 percent to 10 percent of total duct leakage in all climate zones.
9. Increase the prescriptive duct insulation from R-6 to R-8 in Climate Zones 1–2, 4, 8–10, and 12-13.
10. Reduce the 40-foot trigger for prescriptive duct sealing and insulation to 25 feet for altered systems. Eliminate the minimum length requirement for additions and require duct sealing whenever an existing duct system is extended to serve an addition.
11. Add a prescriptive requirement for insulation and sealing in vented attics for altered ceilings or when an entirely new or complete replacement duct system is installed in a vented attic. The requirements apply in all climate

zones except 5 and 7. Various exceptions to this requirement are allowed.

12. New doors that result in an increase in exterior door area must meet the newly constructed building requirements of a maximum U-factor of 0.20.

---

## 1.5 Scope and Application

### 1.5.1 Building Types

Though the Energy Code applies to nonresidential and residential buildings, this compliance manual addresses only the requirements for single-family residential buildings. A companion compliance manual addresses the requirements for nonresidential buildings, including hotels, motels, and multifamily buildings.

- A. **Mixed Low-Rise Residential and Nonresidential Occupancies.** When a building includes both low-rise residential and nonresidential occupancies, the requirements are different depending upon the percentages of the conditioned floor that is occupied by each occupancy type:
  1. **Minor Occupancy** (Exception 1 to §100.0[f]). When a residential occupancy occurs in the same building as a nonresidential occupancy, and if one of the occupancies is less than 20 percent of the total conditioned floor area, the smaller occupancy is considered a “minor” occupancy. Under this scenario, optionally, the entire building may be treated as if it is the major occupancy for envelope, HVAC, and water heating. Lighting requirements in §140.6 through §140.8 or §150.0(k) must be met for each occupancy separately. The mandatory requirements applicable to the minor occupancy, if different from the major occupancy, would still apply.
  2. **Mixed Occupancy.** When residential occupancy is mixed with a nonresidential occupancy, and if neither occupancy is less than 20 percent of the total conditioned floor area, these occupancies fall under different sets of standards and must be considered separately. Two compliance submittals must be prepared, each using the calculations and forms of the respective standards. Separate compliance for each occupancy, to the respective standards, is an option when one of the occupancies is a minor occupancy, as discussed in the paragraph above.
- B. The definition of **a habitable story** in the California Building Code (CBC) is used with the Energy Code. Mezzanines are not counted as separate habitable stories, nor are minor conditioned spaces, such as an enclosed entry stair that leads to an apartment or dwelling unit on the next floor. A habitable story is one that contains space in which people may live or work in reasonable comfort and that has at least 50 percent of the associated volume above grade.
- C. **Live/work buildings** are a special case since they combine residential and nonresidential uses within units. Such newly constructed buildings are common in San Francisco and other urban areas of the state. Even though live/workspaces may be used for an office or a studio, they are typically heated

or cooled or both like a residential building. For this reason, the residential standards are more suitable, and the CEC has made this determination: Either the low-rise or high-rise residential standards apply, depending on the number of habitable stories.

However, lighting in designated workspaces in live/work lofts must comply with the nonresidential prescriptive lighting requirements. See Chapter 5 of the *Nonresidential Compliance Manual* and §140.6 for more information.

**Table 1-2: Building Types Covered by the Low-Rise Residential and Nonresidential Energy Code**

<b>Low-Rise Residential Energy Code (covered in this compliance manual)</b>	<b>Nonresidential Energy Code (covered by Nonresidential Compliance Manual)</b>
All low-rise residential occupancies including single-family homes, duplexes, garden apartments, and other housing types with three or fewer habitable stories.	All nonresidential CBC occupancies (Group A, B, E, F, H, I, M, S, or U), as well as high-rise residential (Groups R-1 and R-2 with four or more habitable stories), and all hotel and motel occupancies.
<p><b>Includes:</b></p> <p>All single-family dwellings of any number of stories (Group R-3)</p> <p>All duplex (two-dwelling) buildings of any number of stories (Group R-3)</p> <p>All multifamily buildings with three or fewer habitable stories (Groups R-1 and R-2)</p> <p>Additions and alterations to all of the above buildings.</p> <p>Lighting requirements for living quarters in high-rise multifamily buildings (more than three stories) and water-heating requirements for high-rise multifamily buildings (more than three stories)</p> <p>Ventilation and filtration (indoor air quality) requirements are similar for single-family and all nontransient multifamily occupancies.</p>	<p><b>Includes:</b></p> <p>Offices</p> <p>Retail and wholesale stores</p> <p>Grocery stores</p> <p>Restaurants</p> <p>Assembly and conference areas</p> <p>Industrial work buildings</p> <p>Commercial or industrial storage</p> <p>Schools and churches</p> <p>Theaters</p> <p>Hotels and motels</p> <p>Healthcare facilities</p> <p>Apartment and multifamily buildings with four or more habitable stories (envelope and HVAC requirements)</p> <p>Long-term care facilities (group R-2) with four or more habitable stories</p> <p>Dormitories or other congregate residences, or any building with dormitory-style sleeping quarters, with four or more habitable stories</p> <p>Private garages, carports, sheds, and agricultural buildings.</p>

### 1.5.2 Explanation of Terms

The term *building type* refers to the classification of buildings defined by the CBC and applicable to the requirements of the *Building Energy Efficiency Standards*. This manual is concerned with the Energy Code that applies to all low-rise residential buildings. The multifamily building is under the scope of the nonresidential requirements, but the dwelling units must meet the lighting, water-heating, and setback thermostat requirements for low-rise residential buildings. A multifamily building contains multiple dwelling units that share common walls (single-family attached) and may also share common floors or ceilings (apartments).

All residential buildings not in the above low-rise category are covered in the 2022 edition of the Energy Commission's *Nonresidential Compliance Manual*. (See Parts 1.1 and 1.2.)

A. A **Single-Family Building** is any of the following:

- A residential building of Occupancy Group R-3 with two or less dwelling units,
- A building of Occupancy Group R-3, other than a multifamily building or hotel/motel building,
- A townhouse,
- A building of Occupancy Group R-3.1, or
- A building of Occupancy Group U when located on a residential site.

B. A **Multifamily Building** is any of the following:

- A building of Occupancy Group R-2, other than a hotel/motel building or timeshare property,
- A building of Occupancy Group R-3 that is a nontransient congregate residence, other than boarding houses of more than 6 guests and alcohol or drug abuse recovery homes of more than 6 guests,
- or A building of Occupancy Group R-4.

C. An **addition** to an existing building increase both the conditioned floor area and volume of a building, which can be new construction or added space conditioning to an existing unconditioned space. See Chapter 9 for more information on energy compliance of additions.

D. An **existing building** is "... a building erected prior to the adoption of [the current] code, or one for which a legal building permit has been issued." (CBC, Part 2)

### 1.5.3 Building Orientation

Building orientation can affect the energy use of a building, particularly in cooling-dominated climate zones with a high amount of west-facing glass. Some prescriptive requirements and performance modeling inputs for compliance with the Energy Code require a description of the building orientation.

#### A. East-Facing

"East-facing is oriented to within 45 degrees of true east, including 45°0'0" south of east (SE), but excluding 45°0'0" north of east (NE)." (§100.1)

#### B. North-Facing

"North-facing is oriented to within 45 degrees of true north, including 45°0'0" east of north (NE), but excluding 45°0'0" west of north (NW)." (§100.1)

#### C. South-Facing

"South-facing is oriented to within 45 degrees of true south, including 45°0'0" west of south (SW), but excluding 45°0'0" east of south (SE)." (§100.1)

#### D. West-Facing

"West-facing is oriented to within 45 degrees of true west, including 45°0'0" due north of west (NW) but excluding 45°0'0" south of west (SW)." (§100.1)

### 1.5.4 Historical Buildings

#### *Exception 1 to §100.0(a)*

Exception 1 to §100.0(a) states that qualified historic buildings, as regulated in the California Historical Building Code (Title 24, Part 8) or California Building Code, Title 24, Part 2, Volume I, Chapter 34, Division II, are not covered by the *Building Energy Efficiency Standards*. Section 140.6(a)3 clarifies that lighting systems in qualified historic buildings are exempt from the lighting power allowances only if they consist solely of historical lighting components or replicas of historical lighting components. If lighting systems in qualified historic buildings contain some historical lighting components or replicas of historical components, combined with other lighting components, only those historical or historical replica components are exempt. All other lighting systems in qualified historic buildings must comply with the *Building Energy Efficiency Standards*.

The California Historical Building Code (CHBC) Section 8-102.1.1 specifies that all nonhistorical additions must comply with the regular code, including the *Building Energy Efficiency Standards*. CHBC Section 8-901.5 specifies that when new or replacement mechanical, plumbing, and electrical (including lighting) equipment or appliances are added to historic buildings, they should comply with the *Building Energy Efficiency Standards*, including the *Appliance Efficiency Regulations*.

The California State Historical Building Safety Board has final authority in interpreting the requirements of the CHBC and determining to what extent the requirements of the *Building Energy Efficiency Standards* apply to new and replacement equipment and other alterations to qualified historic buildings. In enacting the State Historical Building Code legislation, one of the intents of the Legislature was to encourage energy conservation in alterations to historic buildings (Health and Safety Code Section 18951).

Additional information about the CHBC can be found at

<https://www.dgs.ca.gov/DSA/Resources/Page-Content/Resources-List-Folder/SHBSB>

Or contact the SHBSB at (916) 445-7627.

---

### Example 1-1

#### **Question**

Are additions to historic buildings also exempt?



#### **Answer**

If the addition adjoins the qualified historic building, then the enforcement agency at its discretion may exempt those requirements that they determine could damage the historical value of the building. However, “additions which are structurally separated” from the historic building are not exempt from the Energy Code and must comply with building codes, including the Historical Building Code, Title 24, Part 8, Section 8-704.

### Example 1-2

#### **Question**

A sunroom addition is designed with no mechanical heating or cooling and a glass sliding door separating it from all existing conditioned space. Under what conditions will the Energy Code not apply to this addition?





**Source: CEC Photographer: Andersen Windows**

### **Answer**

The mechanical and envelope requirements of the Energy Code do not apply if a building inspector determines that the space is unconditioned. Whether conditioned or unconditioned, per §100.0(c)2, the sunroom must still comply with the applicable lighting requirements of §150.0(k). The sunroom is unconditioned if one of the following apply:

- The new space is not provided with heating or cooling (or supply ducts).
- The new space can be closed off from the existing house with weather-stripped doors.
- The addition is not indirectly conditioned space.

A building official has the discretion to determine whether a sunroom like this qualifies as conditioned space based on the regulatory criteria above. If the building official determines the sunroom is conditioned space, the Energy Code would apply.

---

### **1.5.5 Buildings Not Required to Meet Prescriptive and Performance Standards**

The following building types are not required to meet the prescriptive and performance standards:

- A. Seasonally occupied agricultural housing limited by state or federal agency contract to occupancy not more than 180 days in any calendar year (Exception 1 to §100.0[e]2D); however, these buildings must comply with the applicable mandatory requirements.
- B. Based on discretion of building officials, temporary buildings, temporary outdoor lighting or temporary lighting in an unconditioned building, or

structures erected in response to a natural disaster (Exception 2 to §100.0[a]). These buildings may also may not be required to meet the mandatory and prescriptive requirements of the Energy Code.

### 1.5.6 Building Systems Covered

The single-family residential standards affect the design of the building envelope; the heating, ventilation and air-conditioning (HVAC) system; the water-heating system; and the lighting system. The Energy Code does not apply to residential appliances (*Appliance Efficiency Regulations* may apply), elevators or dumbwaiters, or portable lighting systems that are plugged into a wall outlet. Only hardwired lighting is regulated, which includes lighting that is a permanent part of the building.

### 1.5.7 Additions, Alterations, and Repairs

§100.1(b)

§150.2(a)

§150.2(b)

Additions, alterations, and repairs are common construction projects for California homeowners. The Energy Code applies to both additions and alterations, but not to repairs. See Chapter 9 for details.

- A. **Additions** are changes to an existing building that increase both conditioned floor area and volume.

Chapter 9 includes detailed guidance on showing compliance for accessory dwelling units and converting an existing space to conditioned space.

- B. **Alterations** that are not additions are changes to the envelope, space-conditioning system, water-heating system. or lighting system of a building.
- C. **Repairs** are the reconstruction or renewal of any part of an existing building for maintenance purposes and are not under the scope of the standards. Replacement of any component systems (such as reroofing) or equipment for which there are requirements in the Energy Code is considered an alteration and not a repair.

---

#### Example 1-3

##### Question

The Energy Code does not specify whether buildings damaged by natural disasters can be reconstructed to the original energy performance specifications. What requirements apply under these circumstances?

##### Answer

Buildings destroyed or damaged by natural disasters must comply with the energy code requirements in effect when the builder or owner applies for a permit for those portions of the building that are being rebuilt.

Example 1-4

### Question

Does the Energy Code apply to an addition to a manufactured (“mobile”) home?



Source: CEC Photographer: Brian Vahey

### Answer

No. Title 25 requirements, not Title 24, govern manufactured homes, including additions to the unit. Jurisdiction in a mobile home park comes under the authority of the Department of Housing and Community Development. Jurisdiction of a mobile home on private property may come under the authority of the local building department.

Example 1-5

### Question

Three stories of residential dwelling units are planned over a first story that includes retail and restaurant occupancies. Do the residential apartments need to comply with the residential standards?

### Answer

Yes and No. The building envelope and HVAC equipment must comply with the nonresidential (high-rise residential) standards since the structure contains four habitable stories and, as a whole structure, is a high-rise building. The dwelling units, however, must comply with the lighting and water-heating requirements for low-rise residences.

Example 1-6

### Question

Does a four-story townhouse need to comply with the low-rise residential standards or the high-rise residential standards?

**Answer**

It depends on how the townhouse is classified by the enforcement agency. If the enforcement agency classifies the townhouse as a group R-3 occupancy, the low-rise residential standards will apply. If the townhouse is classified by the enforcement agency as another group R occupancy (i.e., group R-2) and all four stories are habitable, the high-rise residential standards will apply. If the enforcement agency classifies the townhouse as a group R-2 occupancy but three or less of the stories are habitable, the low-rise residential standards will apply.

Example 1-7

**Question**

A 2,100 ft<sup>2</sup> manager's residence is being constructed as part of a new 14,000 ft<sup>2</sup> conditioned warehouse building. Which Energy Code applies?

**Answer**

The whole building can comply with the nonresidential standards, and the residential unit is not required to comply separately since it is a subordinate occupancy containing less than 20 percent of the total conditioned floor area. However, the residential dwelling unit must meet all single-family residential mandatory requirements, as well as the lighting and water-heating requirements.

Example 1-8

**Question**

Assume the same scenario as in the previous example, except that the dwelling unit is new, and the remainder of the building is existing. Do the residential standards apply?

**Answer**

Yes. Since 100 percent of the addition being permitted is a single-family residential occupancy, compliance under the residential standards is required.

Example 1-9

**Question**

A residence is being moved to a different location. What are the applicable compliance requirements?

**Answer**

Because this is an existing conditioned space, the requirements applicable to alterations would apply to any alterations being made. The building does not need to show compliance with the current Energy Code applicable to new buildings or additions.

Example 1-10

**Question**

A previously conditioned retail space is remodeled to become a residential dwelling. What are the applicable compliance requirements?

**Answer**

The remodeled dwelling is treated as if it were previously a residential occupancy. In this case, the rules that apply to residential alterations are applied.

Example 1-11

**Question**

A 10,000 ft<sup>2</sup>, 16-unit motel is constructed with an attached 1,950 ft<sup>2</sup> manager's residence. What are the applicable compliance requirements?



Source: <http://www2.sjsu.edu/faculty/wooda/calpark.jpeg>

**Answer**

The manager's unit is less than 20 percent of the total floor area, so compliance of the whole building as the predominant motel occupancy would satisfy the requirements of the Energy Code. Either the entire building must comply with the nonresidential and hotel/motel standards, or the manager's residence must comply with the single-family residential standards, and the motel occupancy portion of the building must comply with the nonresidential standards.

Example 1-12

**Question**

A subdivision of detached homes includes several unit types, each of which may be constructed in any orientation. What are the applicable compliance requirements?

**Answer**

The single-family residential standards are applied to each building type. All four cardinal orientations may be shown to comply, or each unit in the planned orientation must comply.

Example 1-13

**Question**

A four-story apartment building has three stories of apartments and a garage on the first floor. What are the applicable compliance requirements?

**Answer**

For compliance with the Energy Code, the low-rise residential standards apply since the building has fewer than four habitable stories. However, for other non-energy codes and standards, this may be considered a four-story building.

Example 1-14

**Question**

If, in Example 1-13 above, there was a small air-conditioned elevator lobby at the garage floor, what would be the applicable compliance requirements?

**Answer**

Section 100.1 defines a habitable story as a story that contains space for living, sleeping, eating, or cooking, excluding bathrooms, toilets, hallways, storage areas, closets, utility rooms, and similar areas, and that has at least 50 percent of the volume therein above grade. The small elevator lobby does not meet this definition for habitable story; therefore, the building contains fewer than four habitable stories, and the low-rise residential standards still apply.

Example 1-15

**Question**

If, in Example 1-13 above, there was a receptionist station in the conditioned elevator lobby at the garage floor. what would be the applicable compliance requirements?

**Answer**

In this case, the lobby with the receptionist meets the habitable story definition of §100.1; therefore, the building contains four or more habitable stories and must be considered a high-rise residential occupancy. The building envelope and HVAC equipment must comply with the nonresidential (high-rise residential) standards, and the dwelling units must comply with the lighting and water-heating requirements for low-rise residential buildings.

---

## 1.6 Compliance Approaches and Mandatory Requirements

In addition to the mandatory requirements (Section 1.6.2), the Energy Code provides two basic methods for complying with low-rise residential energy budgets: the prescriptive approach and the performance approach. The mandatory requirements must be installed with either of these approaches, but mandatory requirements may be superseded by more stringent requirements under either approach.

### 1.6.1 Approaches

A. The **prescriptive approach**, composed of a climate zone-dependent

prescriptive package (Section 1.6.3), is less flexible but simpler than the performance approach. Each energy component of the proposed building must meet a prescribed minimum efficiency. The prescriptive approach offers relatively little design flexibility but is easy to use. There is some flexibility for building envelope components. For example, if a portion of a wall does not meet the prescriptive insulation requirement, an area-weighted average of all walls can be used to meet the prescriptive requirement.

- B. The **performance approach** (Section 1.6.4) is more complicated but offers considerable design flexibility. The performance approach uses an approved software program to model a proposed building and compare it to a calculated energy budget. Performance compliance is based on window efficiency and orientation, shading from overhangs, space-conditioning equipment and water-heating system efficiencies, and house configuration. This approach is popular with production builders because it's flexibility and it provides a way to find the most cost-effective solution for complying with the Energy Code.

For additions and alterations, see Chapter 9 for details of compliance approaches that are available.

## 1.6.2 Mandatory Requirements

With either prescriptive or performance compliance, there are mandatory requirements that must always be met. Some deal with infiltration control and lighting; others require minimum insulation levels or equipment efficiencies. New for the *2022 Building Energy Efficiency Standards* are mandatory requirements that require R-20 insulation values for 2' x 6' wood-framed walls, air-filtration devices on most ducted mechanical systems, and kitchen range hoods meeting airflow and sound ratings specified in ASHRAE 62.2. For detailed information on these changes, see applicable sections within this manual.

Minimum mandatory levels are sometimes superseded by more stringent prescriptive or performance approach requirements. For example, if mandatory requirements specify R-22 ceiling insulation and the prescriptive approach is used, then R-38 ceiling insulation (depending on climate zone) must be installed. Conversely, the mandatory requirements may be of a higher efficiency than permitted under the performance approach; in these instances, the higher mandatory levels must be installed. For example, a building may comply using the performance computer modeling only R-7 insulation in a raised floor, but R-19 must be installed because that is the mandatory minimum.

## 1.6.3 Prescriptive Approach

*§150.1(c)*

The prescriptive requirements are represented in Table 150.1-A for single-family . The prescriptive approach is the simplest but least flexible compliance path. The

2019 Energy Code instituted the requirement for a PV system. See Chapter 7 for more information on solar generation, community solar, and battery storage.

The prescriptive approach is a set of predefined performance levels for various building components. Each component meets or exceeds the minimum efficiency level specified in Table 150.1-A and related footnotes in the Energy Code. In some climate zones, these prescriptive requirements specify that many cooling system types are HERS-tested to verify that they have the correct refrigerant charge.

#### **1.6.4 Performance Approach**

The performance approach, also known as the *computer compliance method*, requires that the building comply with the Hourly Source Energy Design Rating (EDR1), Efficiency Energy Design Rating (Efficiency EDR2), and Total Energy Design Rating (Total EDR2). (Additions and alterations continue to meet a time-dependent valuation [TDV] energy budget.) EDR1 is a dimensionless metric. EDR1 is based on hourly source energy; the hourly values for EDR 1 are similar in magnitude to the marginal greenhouse gas emissions of the electricity system. The proposed design EDR1 must be equal to or less than the standard design EDR1. The efficiency EDR2 is the efficiency of the building excluding the benefits from any solar generation. The total EDR2 includes the building plus any solar electric generation. The Energy Design Rating is described in more detail in the *2022 Single-Family Residential Buildings Alternative Calculation Method Reference Manual*.

Annual Time-Dependent Valuation (TDV) energy shall be calculated for the proposed building and compared to the standard TDV energy budget. TDV energy is the “currency” for the performance approach. TDV energy not only considers the type of energy that is used (electricity, gas, or propane), but when it is used. The two independent EDR metrics are based on hourly source energy and TDV, respectively. Energy saved during periods when California is likely to have a statewide system peak is worth more than energy saved at times when supply exceeds demand. Reference Joint Appendix JA3 has more information on TDV energy.

The use of Energy Commission-approved software represents the most detailed and sophisticated method of compliance. While this approach requires the most effort, it also provides the greatest flexibility. The programs automatically calculate the energy budget for space conditioning and water heating, and the minimum required PV size to receive credit toward meeting the efficiency EDR. The budget is determined from the standard design, a computer model of the building using prescriptive requirements. The computer software allows manipulation of the proposed building’s energy features to achieve compliance. See Chapter 8 of this manual for more information on the performance method.

---

## **1.7 Climate Zones**

To standardize calculations and provide a basis for presenting the prescriptive requirements, the Energy Commission has established a set of standard climate data for each of the 16 climate zones. More information is provided in *Reference Joint*



*Appendix JA2* (also included in Appendix B of this document), including a listing of climate zones for all California ZIP codes. *Reference Joint Appendix JA2* gives other climate information, such as design temperatures for sizing HVAC equipment. The climate zone definitions and data are the same for single-family residential, multifamily, and nonresidential standards.

**Figure 1-1: California Climate Zones**

### 1.7.1 Building Location Data

Building location data refer to specific outdoor design conditions used in calculating heating and cooling loads. Different from the climate zone used for compliance (see *Climate Zones* above), design data include the typically warmest and coolest outdoor temperatures that a building is likely to experience in an average year in a particular location.

Temperatures are from the ASHRAE publication, *SPCDX, Climatic Data for Region X - Arizona, California, Hawaii, Nevada*, May 1982 edition. (See Appendix E.) For heating, the outdoor design temperature is the Winter Median of Extremes. A higher temperature is permitted but no lower than this value. For cooling, the outdoor design temperatures must be the 1.0 percent Summer Design Dry Bulb and the 1.0 percent Wet Bulb columns.

If a building location is not listed, the local enforcement agency may determine the location for which data are available that is closest in its design characteristics to the actual building site.

## 1.8 Conditioned Floor Area

**Conditioned floor area (CFA)** is the total floor area (in square feet) of enclosed conditioned space on all floors of a building, as measured at the floor level of the exterior surfaces of exterior walls enclosing the conditioned space (§100.1). This term is also referred to in the Energy Code simply as the *floor area*.

This is an important value for compliance since annual energy use is divided by this value to obtain the energy budget. In the prescriptive package, the maximum fenestration and west-facing fenestration area requirements are expressed as a percentage of this value.

CFA is calculated from the plan dimensions of the building, including the floor area of all conditioned and indirectly conditioned space on all floors. It includes lofts and mezzanines but does not include covered walkways, open roofed-over areas, porches, pipe trenches, exterior terraces or steps, chimneys, roof overhangs, or parking garages. Unheated basements or closets for central gas-forced air furnaces are also not included, unless shown to be indirectly conditioned.

The floor area of an interior stairway is determined as the CFA beneath the stairs and the tread area of the stairs themselves. See Figure 1-2 below for an example of how CFA is calculated.

**Figure 1-2: Total Conditioned Floor Area**

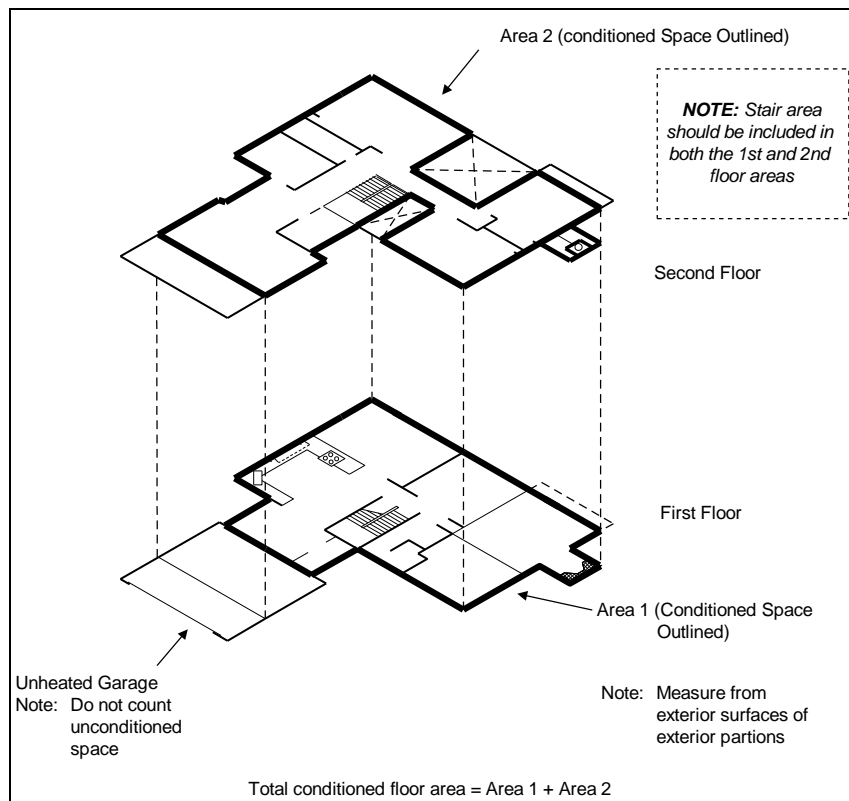

---

## 1.9 Where to Get Help

The Energy Commission has several resources to help designers, builders, homeowners, and others understand and apply the Energy Code.

### 1.9.1 Energy Commission Publications and Support

### 1.9.2 Telephone Hotline

If the information contained in the Energy Code or this compliance manual are not sufficient to answer a specific question concerning compliance or enforcement, technical assistance is available from the Energy Code Hotline.

You can reach the Energy Code Hotline on weekdays from 8 a.m. – noon and 1 p.m. – 4:30 p.m.:

(800) 772-3300

(916) 654-5106

#### A. Publications

Publications, including the 2022 Building Energy Efficiency Standards, the *2022 Reference Appendices*, and the *2022 Residential ACM Approval and Reference Manuals*, and others, are available from the Energy Commission's website at <http://www.energy.ca.gov/title24>. Paper copies may also be ordered from:

Publications Unit

California Energy Commission

715 P Street, MS-5Sacramento, CA 95814

(916) 654-5200

#### B. Blueprint

The Energy Commission publishes the *Blueprint*, a newsletter that answers questions and addresses issues related to enforcement and compliance. The *Blueprint* also provides updated information on technical assistance and computer compliance programs and lists training opportunities offered throughout the state.

The *Blueprint* is available online at

<https://www.energy.ca.gov/newsSroom/blueprint-newsletter>.

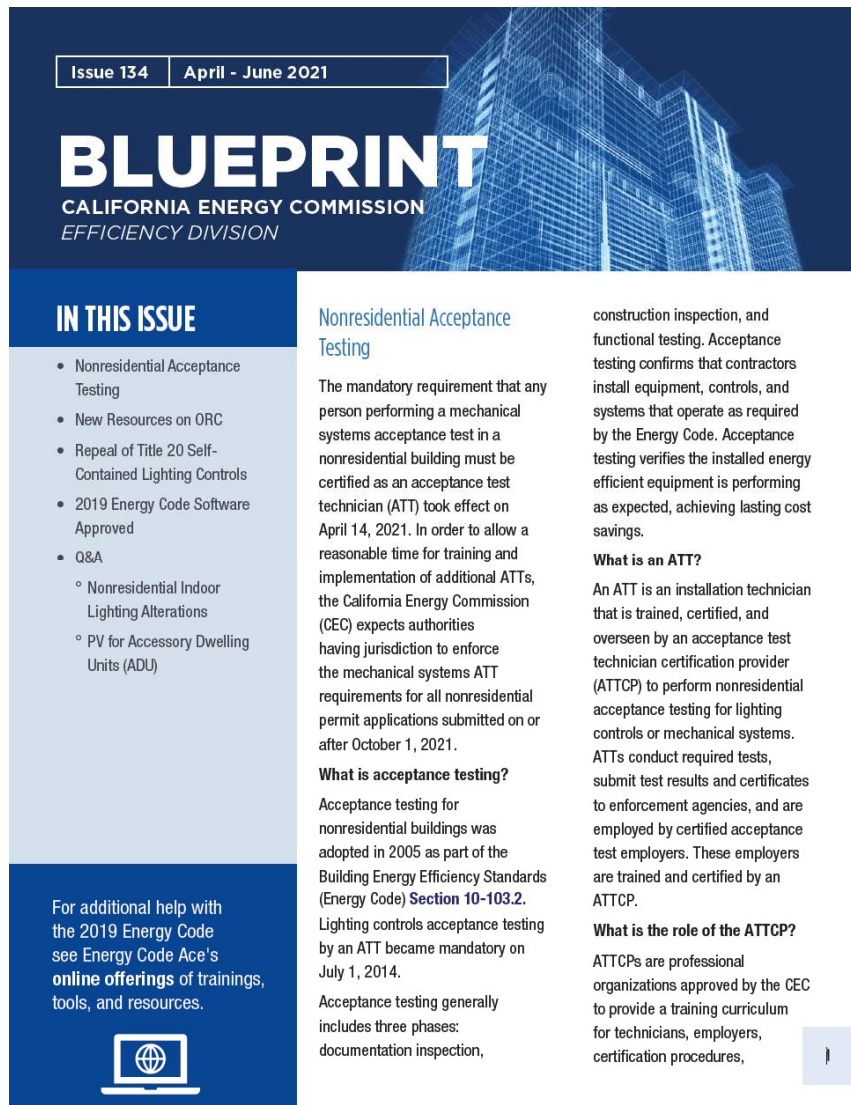
**Figure 1-3: Energy Commission Blueprint Newsletter**

Source: California Energy Commission

### C. Appliance Standards

Appliances, as defined by the CEC, include everything from dishwashers and refrigerators to air conditioners and boilers. The performance of some appliances, such as air conditioners, water heaters, and furnaces, is critical to the *Building Energy Efficiency Standards*. The energy efficiency of other appliances, such as refrigerators, dishwashers, and clothes dryers, is important to homeowners but does not affect the *Building Energy Efficiency Standards* since these are considered home furnishings.

The CEC has comprehensive standards that affect the performance of many appliances. [Appliance Standards information](https://www.energy.ca.gov/rules-and-regulations/appliance-efficiency-regulations-) is available from the CEC website at <https://www.energy.ca.gov/rules-and-regulations/appliance-efficiency-regulations->

[title-20](#).

#### D. Appliance Directories

The CEC publishes information on the energy efficiency of appliances. CEC-approved directories can be used to determine if appliances meet the mandatory requirements or the prescriptive requirements or both. Data may also be used in performance calculations. The Energy Code Hotline can verify certification of appliances and provide information on appropriate directories.

The [complete appliance database](#) (including manufacturer, brand codes, rated efficiencies, and so forth) can be searched from the Energy Commission's website at

<http://www.appliances.energy.ca.gov/cacertappliances.energy.ca.gov/Pages/ApplianceSearch.aspx>.

#### E. Directory of Certified Insulation Materials

Manufacturers whose insulating materials are certified for sale in California are listed in the Department of Consumer Affairs' *Consumer Guide and Directory of Certified Insulation Material*. Each building department receives a copy of this directory. If an insulating product is not listed in the directory, or if you want to purchase a directory, contact the Department of Consumer Affairs, Bureau of Household Goods and Services (BHGS), at (916) 999-2041 or visit <https://bhgs.dca.ca.gov/>

### 1.9.3 Training Opportunities

California utilities, organizations of energy consultants, building industry, trade associations, and organizations that serve building officials often sponsor or conduct classes on compliance and enforcement of the Energy Code. These classes are linked on the [CEC's Online Resource Center](#) at <http://www.energy.ca.gov/title24/orc>.

[Energy Code Ace](#) offers free tools, training, and resources to help identify the compliance documents, installation techniques, and standards relevant to building projects in California. Energy Code Ace resources provide fact sheets, trigger sheets, and checklists to help readers understand when Title 24, Part 6 is "triggered" and how to correctly comply when it is.

This program is funded by California utility customers under the auspices of the California Public Utilities Commission and in support of the Energy Commission.

<http://energycodeace.com/>

### 1.9.4 Energy Consultants

The [California Association of Building Energy Consultants \(CABEC\)](#) maintains a directory of consultants who provide compliance assistance. The listing is available at <http://www.cabec.org>.

### **1.9.5 Online Videos**

The CEC has a series of streaming videos that explain energy efficiency concepts and the application of the Energy Code. These videos cover topics including lighting, and HVAC. They can be viewed at <https://www.energy.ca.gov/title24/orc/>.

### **1.9.6 HERS Raters and Providers**

To comply with the Energy Code, some buildings require third-party diagnostic testing or field verification of energy-efficient systems or devices. HERS Raters are required to be hired by the builder or building owner to perform this work. Installing contractors may hire the HERS Rater for HVAC changeouts only if the homeowner agrees that the installing contractor may do so on his or her behalf. The CEC approves HERS providers who train, certify, and monitor HERS Raters. For a list of the current HERS providers, please go the Energy Commission website at <http://www.energy.ca.gov/HERS/>. To find a Rater, go to the website of the approved HERS provider available on the Energy Commission's website at the link above, or contact the Energy Code Hotline at (800) 772-3300 (for calls within California) or (916) 654-5106 for assistance.

**TABLE OF CONTENTS**

2. Compliance and Enforcement..... 1

2.1. Overview ..... 1

2.1.1 Manufacturer Certification for Equipment, Products, and Devices ..... 2

2.1.2 HERS Program Compliance Document Registration ..... 3

2.2. Compliance Phases ..... 4

2.2.1 Compliance Documentation ..... 4

2.2.2 Design Phase ..... 5

2.2.3 Permit Application..... 6

2.2.4 Plan Check ..... 6

2.2.5 Building Permit..... 8

2.2.6 Construction Phase ..... 9

2.2.7 Enforcement Agency Field Inspection ..... 10

2.2.8 Field Verification and Diagnostic Testing ..... 11

2.2.9 Approval for Occupancy ..... 13

2.2.10 Occupancy ..... 13

2.3. Compliance Documentation ..... 13

2.3.1 Building Permit Phase Documentation ..... 15

2.3.2 Certificate of Compliance (CF1R)..... 15

2.3.3 Construction Phase Documentation (CF2R) ..... 16

2.3.4 Field Verification and Diagnostic Testing Documentation (CF3R)..... 17

2.3.5 Compliance, Operating, Maintenance, and Ventilation Information to Be  
Provided by Builder ..... 18

2.4. Roles and Responsibilities..... 20

2.4.1 Designer ..... 20

2.4.2 Documentation Author ..... 21

2.4.3 Builder or General Contractor..... 21

2.4.4 Specialty Subcontractors ..... 23

2.4.5 Enforcement Agency ..... 23

2.4.6 HERS Provider ..... 27



---

2.4.7	HERS Rater .....	28
2.4.8	Third Party Quality Control Program .....	31
2.4.9	Owner.....	32
2.5.	HERS Field Verification and Diagnostic Testing .....	33
2.5.1	Measures Requiring HERS Field Verification and Diagnostic Testing.....	33
2.5.2	Verification, Testing, and Sampling.....	35
2.5.3	Initial HERS Testing for Subdivision Projects.....	35
2.5.4	Group Sample HERS Testing for Subdivisions .....	36
2.5.5	Resampling, Full Testing, and Corrective Action.....	38
2.5.6	Installer Requirements and HERS Procedures for Alterations.....	38
2.5.7	For More Information .....	39

## 2. Compliance and Enforcement

### 2.1. Overview

The California Energy Commission (CEC) does not directly enforce the Building Energy Efficiency Standards (Energy Code), Title 24, Part 6 of the California Code of Regulations. Authorities having jurisdiction (AHJ) have the responsibility of issuing building permits for newly constructed buildings or additions and alterations to existing buildings and enforcing the California Building Code (CBC), Title 24 of the California Code of Regulations in totality, including the Energy Code. Most AHJs are local enforcement agencies, typically associated with a city or county government, but can also include other agencies such as the Division of the State Architect (for schools). This chapter of the Single-Family Compliance Manual will show how compliance and enforcement of the Energy Code is achieved in the typical single-family residential building project permitting process used by most AHJs, which follow some version of the permitting process prescribed by the International Code Council (ICC). Figure 2.1-1 shows an idealized version of the ICC permitting process.

**Figure 2.1-1: Idealized International Code Council Permitting Process for Building Permit Applications**

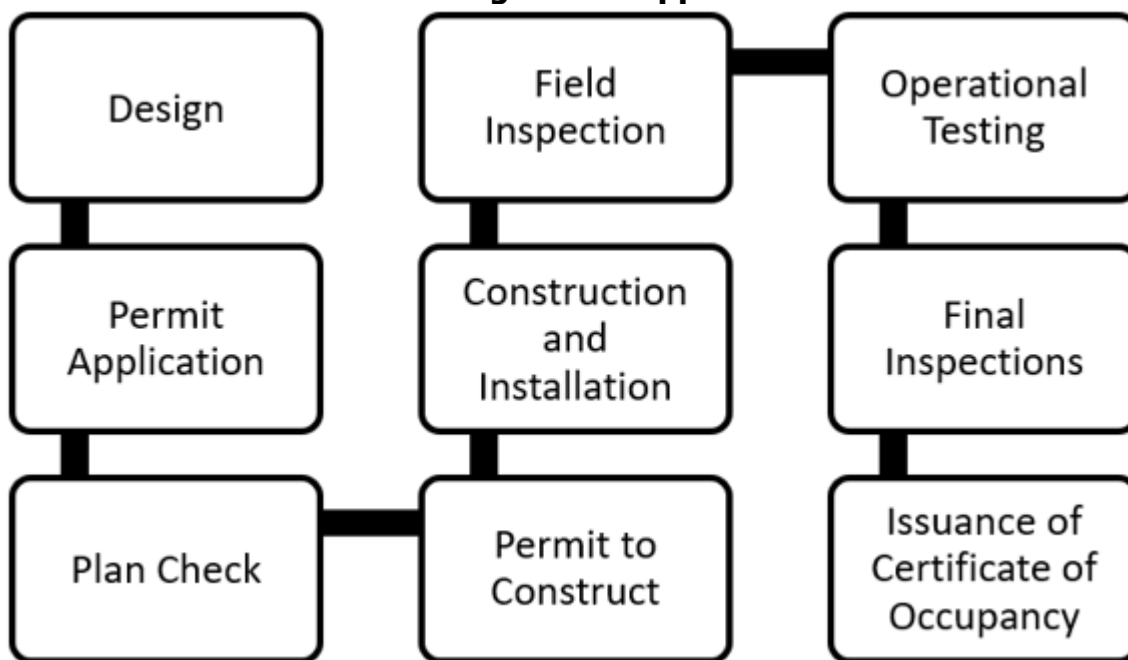

Source: California Energy Commission staff

To assist the enforcement agency, the CEC created three categories of compliance documents for single-family construction projects used to demonstrate compliance with the Energy Code:

- Certificate of compliance documents (CF1R) are completed by the project proponent and submitted to the enforcement agency during the plan review phase (§10-103[a]1).
- Certificates of installation (CF2R) are completed by the installing technician or contractor during construction and submitted to the enforcement agency during inspections throughout the construction phase (§10-103[a]3).
- Certificates of verification (CF3R) are completed by HERS Rater certified by a CEC-approved HERS Provider and submitted to the enforcement agency during the final inspection phase and prior to the enforcement agency issuing the certificate of occupancy (§10-103[a]5).

HERS Raters are independent, third-party agents, made available through the CEC's Home Energy Rating System (HERS) program. The HERS program consists of HERS Providers, approved by the CEC to train, certify, and oversee HERS Raters, who perform verification and diagnostic testing as required for compliance with the Energy Code.

HERS verification ensures the proposed HERS measures are installed and meet code compliance. The compliance and enforcement process requires participation from the architect, building designer, engineers, energy consultants, contractors, the owner, HERS Raters, and others. This chapter describes the overall compliance and enforcement process and responsibilities throughout the permit process.

### **2.1.1 Manufacturer Certification for Equipment, Products, and Devices**

During the permit application development phase, certain equipment, products, and devices must be selected for installation or use that are certified to be compliant with the Energy Code. These items are identified on the CF1Rs and are verified during inspection by the enforcement agency. The equipment, products, and devices must be certified to the CEC by the manufacturer that it meets requirements under the Energy Code. The CEC makes no claim that the listed equipment, products, or devices meet the indicated requirements or, if tested, will confirm the indicated results. Inclusion on these lists only confirms only that a manufacturer certification has been submitted to and accepted by the CEC. [Additional information](#) about the required information for manufacturers to certify products and for lists of certified products may be found at [http://www.energy.ca.gov/title24/equipment\\_cert/](http://www.energy.ca.gov/title24/equipment_cert/).

In single-family buildings, the following must be certified by the manufacturer:

- Air economizers
- Airflow measurement apparatus — forced air systems
- Airflow measurement apparatus — ventilation systems
- Airflow measurement apparatus — whole house fan systems
- Battery and energy storage systems

- Central heat pump water heater performance map
- Demand responsive lighting control systems
- Drain water heat recovery
- Ducted variable-capacity heat pump
- Economizer fault detection and diagnostics
- Intermittent mechanical ventilation systems
- JA13 heat pump water heater demand management system
- Low leakage air-handling unit
- Occupant-controlled smart thermostats
- Residential fault indicator display

### **2.1.2 HERS Program Compliance Document Registration**

*§10-103;  
Reference Residential Appendix RA2;  
Reference Joint Appendix JA7*

The CEC developed the HERS program in part to help ensure compliance with the Energy Code for residential projects that require field verification and diagnostic tests (HERS Verification). Registration of compliance documentation (CF1Rs, CF2Rs, and CF3Rs) is required for any residential construction project for which a CF3R is required. (Not all residential construction projects require a CF3R.) Reference Residential Appendix RA2 *and Reference Joint Appendix JA7* provide detailed descriptions of procedures and responsibilities for the registration of CF1R, CF2R, and CF3R.

Compliance document registration is required for all newly constructed homes, most additions, and many alterations. When registration is required, compliance documents must be electronically submitted to a CEC-approved HERS Provider. The HERS Provider services include a HERS data registry (HERS registry) for the registration and retention of compliance documents.

All compliance documents (CF1Rs, CF2Rs, and CF3Rs) submitted to the registry must be certified and signed by the applicable responsible person (§10-103) as well as any other required signatories. The registry will assign a unique registration number to each document when completed, and certification (by an electronic signature) is provided by all signatories. The registry will retain the unique registered documents, which are available via secure Internet access to authorized users. This allows authorized users download unalterable electronic certificates or to make paper copies of the registered documents for purposes such as submittal to the enforcement agency, posting in the field for inspections, or sharing with the building owner. (See Section 2.2.9 of this manual.)

Types of registry users include energy consultants, builders, building owners, construction contractors and installers, HERS Raters, enforcement agencies, and the CEC. Document authors are typically employed by the person responsible for the document, with specific exceptions. Authorized users are granted access rights to the electronic data associated with the projects under their direct control.

---

## **2.2. Compliance Phases**

### **2.2.1 Compliance Documentation**

Complying with and enforcing the Energy Code in residential buildings involves many parties. Those involved may include the architect or designer, builder/developer, purchasing agent, general contractor, subcontractor/installer, energy consultant, plan examiner, inspector, Realtor®, and owner/first occupant. All these parties must communicate and cooperate for the compliance and enforcement process to run efficiently.

The Energy Code specifies detailed reporting requirements intended to provide design, construction, and enforcement parties with the information to ensure that the energy features are properly installed. Each party is accountable to ensure that the features that it is responsible for are correctly installed. This section outlines each phase of the process, responsibilities, and requirements.

The energy compliance documentation has been revised and reorganized. Prescriptive (Chapter 1.6) versions of the certificate of compliance (CF1R) have been designed to be used specifically with:

1. Single-family residential newly constructed buildings (CF1R-NCB-01).
2. Single-family residential additions (CF1R-ADD-01).
3. Single-family residential alterations (CF1R-ALT-01).
4. Single-family residential HVAC changeouts (CF1R-ALT-02).
5. Solar water heating worksheet (CF1R-STH-01).

The certificate of installation (CF2R) is separated into:

1. Envelope (CF2R-ENV).
2. Lighting (CF2R-LTG).
3. Mechanical (CF2R-MCH).
4. Plumbing (CF2R-PLB).
5. Photovoltaic and battery storage, solar-ready zone area, and solar thermal water heating (CF2R- PVB, SRA, and STH, respectively).

These categories and most compliance measures have a separate CF2R form that is specific to a particular installation. CF2R forms also incorporate references to applicable mandatory requirements. The HERS certificate of verification (CF3R) forms are categorized and organized in the same way as the CF2R forms. Refer to

Appendix A of this manual for more information about the forms and to view samples of the forms. Additional information about the compliance documents will be provided throughout this manual.

When HERS Verification is required for compliance, the Energy Code requires all residential energy compliance documents to be registered with a HERS data registry. This registration accomplishes retention of a completed and signed copy of the submitted energy compliance documentation. To simplify the permit process for HVAC changeouts, §10-103 of the Energy Code allows the registered CF1R-ALT-02 document to be submitted to an enforcement agency at final inspection and not before obtaining a permit. More details are in Chapter 9 of this manual. Document retention is vital to compliance and enforcement follow-up and other quality assurance follow-up processes that ensure energy savings from installed energy features. Reference Residential Appendix RA2 and Reference Joint Appendix JA7 has more details about document registration procedures building energy code compliance and enforcement process.

### 2.2.2 Design Phase

#### §10-103(a)2

This phase sets the stage for the construction project, whether it be a newly constructed building, an addition, or an alteration to an existing home. In addition to issues concerning zoning, lot orientation, property line easements, and infrastructure (such as utility hookups), the overall design and energy features of the building are described in the construction documents and specifications. The project owner must ensure that the building complies with the Energy Code and that the significant features required for compliance are documented on the plans and specifications and are consistent with the CF1Rs.

During the design process, an energy consultant or other professional may assist the building designer by providing energy compliance documentation services that determine the effect of building features being proposed for the design. These services help ensure that the final building design plans and specifications submitted to the enforcement agency will comply with the Energy Code. Throughout this phase, energy consultants or the documentation author may suggest recommendations or alternatives to help the designer achieve compliance.

The building design plans submitted to the enforcement agency must include the specifications for the building energy features needed to achieve compliance. The building features are insulation levels, window performance, equipment performance, lighting fixture types and controls, exhaust fan performance, envelope sealing, weather-stripping requirements, and any other feature that was used for compliance or is mandatory. The building design plans and specifications must be consistent with respect to the energy efficiency features information on the CF1R submitted to the enforcement agency. Any change in the building plans or specifications, during any phase of design or construction, that changes the energy

feature specifications for the design may require recalculation of the building energy compliance. A revised CF1R that is consistent with the updated plans and specifications for the proposed building may need to be submitted to the enforcement agency for approval. If recalculation indicates that the building no longer complies, alternate building features must be selected so that it complies with the Energy Code.

### 2.2.3 Permit Application

*§10-103(a)2*  
*§10-103(a)1C*

When the design is complete, the construction documents are prepared (CF1Rs), and other approvals (planning department, water, and so forth) are secured, the owner or contractor applies for a building permit with the enforcement agency. This application is the last step in the planning and design process.

To help the enforcement agency verify that the proposed building complies with the Energy Code, compliance documents are submitted with the building permit application. These documents consist of a CF1R, which is required by the Energy Code. (See §10-103.) The length and complexity of the documentation vary depending on the scope of the project. For example, the number and type of components being replaced (windows, space conditioning equipment, roof replacement, ceiling insulation, and so forth), the number of buildings being constructed, the size of an addition, whether an orientation-independent permit is being requested, and whether the performance approach or the prescriptive approach is being used. An energy consultant who understands the code and is able to help the builder or owner comply with the standards often prepares the CF1R.

The administrative regulations in §10-103(a)2 require that documentation be submitted with permit applications that will enable the plans examiner to verify compliance. The forms used to demonstrate compliance must be readily legible and shall conform to a format and informational order and content approved by the CEC. If registration is required, the CF1R that is submitted to the enforcement agency must be a registered copy from an approved HERS registry.

### 2.2.4 Plan Check

The registration process requires the builder or designer to submit the certificate of compliance information and an electronic signature to an approved HERS registry to produce a completed, signed, and dated electronic CF1R that is retained by the registry. Copies of the registered CF1R are available to authorized users of the HERS registry for use in making electronic or paper copies of the registered document(s) for submitting to the enforcement agency as described in Section 10-103.

Local enforcement agencies check plans to ensure that the building design conforms to the Energy Code. This check focuses primarily on the fire, life, and safety requirements of the CBC and secondarily on the building energy efficiency

requirements. Vague, missing, or incorrect information on the construction documents are identified by the plans examiner. The permit applicant is required to make corrections or clarifications then resubmit revised plans and specifications. Submitting complete and accurate plans and specifications provides the plans examiner with the information needed to complete the plan check review quickly.

The plans examiner verifies that the information on the construction documents is consistent with the requirements specified on the CF1R. Examples of how the plans examiner will verify that the features detailed on the CF1R are specified in the respective sections of the building plans include:

1. Verifying the window and skylight U-factor and solar heat gain coefficient (SHGC) values from the CF1R on the structural/architecture plans in a window/skylight schedule, window/skylight legend for the floor plan.
2. Verifying the HVAC equipment and distribution information from the CF1R is clearly documented on the plans, such as SEER, EER, AFUE, mandatory, prescriptive, and elective HERS measures, and other values necessary to verify compliance.

The plans examiner compares the data on the CF1Rs against the rest of the plans and documents submitted for the permit applications, including all the following subject areas:

- Envelope (walls, ceiling, floors)
  - Windows, skylights, and doors solar heat gain coefficients
  - Insulation and air sealing
  - Advanced wall and ceiling construction and insulation
- Roofing materials and construction
  - Roof-deck insulation
  - E-barrier
  - Ventilation or sealed attic
  - Cool roof reflectivity requirements
- Heating, ventilating, and air conditioning (HVAC)
  - SEER, EER and AFUE (if applicable) for HVAC equipment
  - Ducting design and register placement
  - Ventilation and indoor air quality requirements
  - Duct insulation and placement (in or outside conditioned space)
  - Thermostat requirements
  - Manufacturer certification check
- Lighting requirements
  - Luminaire efficacy requirements



- Switching and control devices
- Outdoor lighting and controls
- Domestic hot water
  - Manufacturer certification check
  - Water piping design and insulation

The enforcement agency should clearly articulate to the builder/designer the acceptable methods of specifying energy features on the building plans for approval.

Since those buying building materials and the construction staff may rely solely on a copy of the approved plans and specifications, it is important that the building design represented on the approved plans and specifications complies with the Energy Code as specified on the CF1R.

The enforcement agency's plans examiner must also verify that the CF1R does not contain errors. Newly constructed buildings using the performance approach are required to use CEC-approved computer software; additions and alterations generally use the prescriptive method, with the option of using performance modeling software. When the CF1R is produced by CEC-approved computer software applications, there is less chance that there will be computational errors. The plans examiner must still verify that the design on the plans is consistent with the energy features on the certificate of compliance documents (CF1Rs). A list of CEC-approved energy code compliance software applications is available online at the [CEC Compliance Software](https://www.energy.ca.gov/programs-and-topics/programs/building-energy-efficiency-standards/online-resource-center/compliance) website (<https://www.energy.ca.gov/programs-and-topics/programs/building-energy-efficiency-standards/online-resource-center/compliance>).

The Building Energy Efficiency Standards Hotline at 1-800-772-3300 can assist with locating and installing this software.

With production homes, where a builder may be constructing several identical houses at roughly the same time, the compliance documentation may be prepared in such a way that a house or model can be constructed in any orientation. The plans examiner will verify that the home complies facing all four main compass points (north, south, east, and west) on the CF1R form.

### **2.2.5 Building Permit**

After the plans examiner has approved the plans and specifications for the project, the enforcement agency may issue the building permit at the builder's request. Issuing the building permit is the first significant milestone in the compliance and enforcement process. The building permit is the green light for the contractor to begin the work. In some cases, the building permits are issued in phases. Sometimes, there is a permit for site work and grading before the permit for actual building construction.

## 2.2.6 Construction Phase

Upon receiving a building permit from the enforcement agency, the contractor begins construction. The permit requires the contractor to follow the plans and specifications, but often there are variations. Some variations are formalized through change orders. When change orders are issued, the permit applicant and the AHJ are responsible for verifying that the changes do not compromise compliance with the code. It is clear in some cases such as when a single-glazed, metal-frame window is substituted for a high-performance double-pane, vinyl-frame window. It may be difficult to determine compliance with changes such as orientation of the house or the location of a window. Field changes that result in noncompliance require enforcement agency approval of revised plans and revised energy compliance documentation to confirm that the building still complies with the Energy Code.

During construction, the general contractor or specialty subcontractors are required to complete various CF2Rs. These certificates verify that the contractor is aware of the Energy Code requirements and has followed the CEC-approved procedures for installation. These certificates are to identify the energy efficiencies and features of the installed building components. The CF2Rs are a collection of energy compliance information forms that apply to each regulated energy feature that may be included in the construction. The certificates are required to be completed by each of the applicable specialty contractors when they install regulated energy features such as windows, water heater and plumbing, HVAC ducts and equipment, lighting, and insulation.

The licensed person responsible for the building construction or installation of an energy-related feature must ensure their work is done in accordance with the approved plans and specifications for the building. The person must complete and sign a certificate of installation to certify that the installed features, materials, components, or manufactured devices for which they are responsible conform to the plans and specifications and the certificate of compliance documents approved by the enforcement agency for the building. A copy of the completed, signed, and dated CF2R must be posted at the building site for review by the enforcement agency in conjunction with requests for final inspection for the building. Copies of the registered CF2R forms shall be provided to the homeowner.

When any HERS verification is required for compliance, all CF2R forms must be registered with an approved HERS data registry. When registration is required, the builder or installing contractor must submit information to an approved registry to produce a completed, signed, and dated electronic CF2R that is retained by the registry for use by authorized users of the registry. After the information to complete the CF2R document is transmitted to the HERS registry and the form is electronically signed, the CF2R is assigned a registration number. Copies of the unique registered CF2R are made available to authorized users of the registry to make electronic or paper copies of the registered document(s) for submittal to the

enforcement agency as required. The builder or installing contractor must provide a copy of the completed, signed, and registered CF2R to the HERS Rater and post a copy at the building site for review by the enforcement agency in conjunction with requests for final inspection and provide copies of the registered CF2R forms to the homeowner.

More information about registering CF2R documents can be found in Reference Residential Appendix RA2 and Reference Joint Appendix JA7.

### **2.2.7 Enforcement Agency Field Inspection**

#### **§10-103(d)**

Enforcement agency representatives inspect construction projects to ensure compliance with the Energy Code. Field construction changes and noncompliant energy features require parties associated with previous phases to repeat and revise their original energy compliance documents or reinstall building components that meet the building specifications and energy compliance documents.

Enforcement agencies make several visits to a building site to verify construction. The first visit is typically made before the slab or building foundation is poured. The building inspector verifies that the proper reinforcing steel is in place and necessary wiring and plumbing that will be embedded in the slab meet the requirements of the standards. The inspector should verify features that are to be installed in or under concrete slab floors, such as slab edge insulation or hot water recirculation loops that involve piping that must be installed in the slab. The inspector should also verify the front orientation and floor assembly types (such as slab on grade, raised floor, and others) of the building during this construction phase. Details of how the inspector should verify these components are in Chapter 3 of this manual.

The second visit occurs after the walls have been framed, and the HVAC equipment and ducting, fenestration, lighting cans, electrical wiring, plumbing, and other services have been constructed or installed. This inspection should be done before insulation is installed to ensure sealing and caulking around windows is completed, and the caulking and sealing of any holes bored through the framing members for installation of hot and cold water piping and electrical wiring. During the rough frame inspection, the inspector should also verify the installation of the high-efficacy lighting so that the contractor can make any necessary corrections before the final inspection. This verification avoids having to remove drywall, insulation, and so forth to remove an incandescent can. The inspector should also verify the window/skylight U-factor and SHGC values, proper sealing/installation of HVAC ducts and duct insulation R-value, installation of exhaust fan housing and ducting in bathrooms and kitchens (ASHRAE 62.2), and installation of a radiant barrier or cool roof or a combination thereof when required. Details of how the inspector should verify these components will be discussed in the respective chapters of this manual.

The third visit is the insulation inspection, which takes place after the wall, ceiling, and floor insulation have been installed. This inspection occurs before the drywall is

installed to verify that the insulation R-value matches the CF1R form, and the insulation has been properly installed without compressions, voids, or gaps. The inspector should verify that insulation is installed correctly around and behind piping and all exterior walls are insulated (especially behind obstructing objects like a bathtub). Details of how the inspector should verify these components are in Chapter 3.

The next visit is a drywall inspection, where the inspector verifies that the drywall is installed properly to limit infiltration and exfiltration, especially at locations surrounding lighting cans, HVAC registers and vents, and electrical sockets.

The final inspection is conducted after the walls have been closed and the final electrical and plumbing fixtures are in place. The inspector should verify HVAC efficiency values, water heating efficiency values, exhaust fan and other ventilation system noise level ratings in bathrooms and kitchens (ASHRAE 62.2), filter MERV rating and thickness, exterior lighting and controls, and weatherstripping on exterior/demising doors. The inspector will also verify that all required CF2R and CF3R forms have been completed, signed, and registered. Copies of these forms should be provided to the building owner. Details of how the inspector should verify these components will be discussed in this manual.

The typical enforcement agency inspection sequence can vary from jurisdiction to jurisdiction. It can be difficult for the enforcement agency to verify every energy efficiency measure required to be installed in the building. For example, exterior wall insulation will likely not be installed at the time of the framing inspection. If the enforcement agency does not include the insulation inspection in its field inspection, the exterior wall insulation would be concealed from an inspector's view at the final inspection.

The CF2Rs and, when required, the CF3Rs are crucial. When inspection of an installed energy feature would be impossible because of subsequent construction, the enforcement agency may require the CF2R for the concealed feature to be posted at the site or made available to the inspector upon completion/installation of the feature. To simplify the inspection, the inspector would reference the efficiency values and building components specified on the submitted CF2R form to verify compliance with the Energy Code.

When registration is required, all certificates of installation must be registered through an approved HERS data registry. For all measures requiring field verification, a registered certificate of verification shall also be made available to the building inspector.

## **2.2.8 Field Verification and Diagnostic Testing**

Some building features require field verification and diagnostic testing completed by a HERS Rater as a condition for compliance with the Energy Code. When compliance with the Energy Code is based on energy features that require a HERS verification, a certified HERS Rater is required to perform the test according to procedures in

Reference Residential Appendix RA2 using the protocols in Reference Residential Appendix RA3.

There are mandatory requirements, prescriptive requirements, and performance credits (Chapter 1) that require HERS testing. Many requirements that require verification and testing involve air-conditioning equipment and forced-air ducts that deliver conditioned air to the dwelling. Examples of measures requiring HERS testing are refrigerant charge measurement and duct sealing. An example of an installed feature that does not require HERS testing is lighting control in spaces like a laundry room or bathroom.

The Energy Code mandates that all newly constructed homes with central HVAC systems have duct sealing (leakage testing), duct system airflow and fan watt draw (and installed HSPP/PSPP), and exhaust fans/systems (ASHRAE 62.2) verified by a HERS Rater when those systems are installed. Details about these measures are in Chapter 4 of this manual.

Additional measures requiring field verification include reduced duct surface area, increased duct R-value, high SEER and EER cooling equipment, and quality installation of insulation (QII). A full list of measures requiring field verification or diagnostic testing is in Table RA2-1 of the *2022 Reference Residential Appendices*. The requirements for field verification and diagnostic testing apply only when equipment or systems are installed. If a house has no air distribution ducts, then a HERS Rater does not have to test them.

The HERS Rater must verify the required features and transmit all required data describing the feature and the test results to an approved HERS registry. The rater must confirm that the installed energy feature being verified is consistent with the requirements for that feature as specified on registered copies of the CF1R approved by the enforcement agency for the dwelling. The HERS Rater must confirm the information on the CF2R is consistent with the CF1R. The test results reported on the CF2R by the person responsible for the installation must be consistent with the HERS verification results determined by the HERS Rater's diagnostic verification and meet the criteria for standards compliance. A copy of the registered CF2R must be posted at the building site for review by the enforcement agency and made available for applicable inspections. A copy of the registered CF2R must also be left in the dwelling for the homeowner at occupancy.

Results from the rater's field verification or diagnostic test are reported to the HERS registry with "pass" or "fail." If the results are "pass," the registry will make a registered copy of the CF3R available. A copy of the registered CF3R must be posted at the building site for review by the enforcement agency and made available for all applicable inspections. Copies must be given to the builder and left in the dwelling for the homeowner at occupancy. If results are "fail," that failure must be entered into the registry. HERS Providers shall not permit any user of the registry to print or access forms for noncompliant entries unless the CF3R form contains a watermark

with the word “FAIL” or “FAILURE.” Corrective action shall be taken by the builder or installer on the failed requirement. The rater will retest the requirement to verify that the corrective action was successful. Once the correction is made, the passing CF3R shall be entered into the registry.

### **2.2.9 Approval for Occupancy**

For newly constructed buildings and additions, the final step in the permitting process is for the enforcement agency to issue an occupancy permit so occupants can move in. Single-family homes and duplexes are often approved for occupancy without an occupancy permit being issued. Often a signed-off final inspection serves as an approval for occupancy, but this depends on the enforcement agency. When HERS verification is required before occupancy approval, the HERS Rater must post paper copies of the registered CF3Rs for site review by the building owner, installers, and inspectors.

For alterations to existing buildings, the signed-off final inspection is all that is required. Since the project is in a building with an existing occupancy permit, the enforcement agency is not required to issue a new occupancy permit. It should be noted that the extent of the alteration is limited by the Energy Code and, typically, the local codes and standards. If an alteration is too extensive, it can be considered a newly constructed building. For example, removing all wallboards, insulation, and exterior walls from a building could be considered a newly constructed building and not an alteration by the enforcement agency.

### **2.2.10 Occupancy**

At the occupancy phase, the enforcement agency must require the builder to leave all compliance documentation in the building, which includes at a minimum the CF1R and all applicable CF2R forms. When HERS field verification is required, copies of the registered CF3Rs must be left on site with the compliance documentation. When registration is required, the CF1R and all required CF2R compliance documentation shall be registered copies. The builder is required to provide the homeowner with a manual that contains instructions for operating and maintaining the features of his or her building efficiently. More details are in Section 2.3.5.

---

## **2.3. Compliance Documentation**

Compliance documentation includes the forms, reports, and other information that are submitted to the enforcement agency with an application for a building permit. It also includes documentation completed by the contractor or subcontractors to verify that certain systems and equipment have been installed correctly. It may include reports and test results by HERS Raters. The compliance documentation (CF1R, CF2R, and CF3R) is included with a homeowner’s manual so that the end user knows what energy features are installed in the house.

Compliance documentation is completed at the building permit phase, the construction phase, the field verification and diagnostic testing phase, and the final

inspection phase. The required forms and documents are in Table 2.3-1 and described later. When registration is required, all the compliance documentation shall be registered copies from an approved HERS data registry.

**Table 2.3-1: Documentation Requirements, Prescriptive and Performance Compliance Methods**

A complete list and samples of energy compliance forms is in Appendix A.

<b>Phase</b>	<b>Method</b>	<b>Documentation Required When Applicable</b>
Building Permit	Performance	CF1R-PRF-E, Certificate of Compliance
Building Permit	Prescriptive	CF1R-NCB-01-E, Certificate of Compliance
Building Permit	Prescriptive	CF1R-ADD-01-E, Certificate of Compliance (Additions less than 1,000 ft <sup>2</sup> )
Building Permit	Prescriptive	CF1R-ALT-01-E, Certificate of Compliance (Residential Alterations)
Building Permit	Prescriptive	CF1R-ALT-02-E, Certificate of Compliance (Alterations to HVAC systems)
Building Permit	Prescriptive	CF1R-ENV-02-E, Worksheet for area weighted average
Building Permit	Prescriptive	CF1R-ENV-03-E, Worksheet for solar heat gain coefficient (SHGC)
Building Permit	Prescriptive	CF1R-ENV-04-E, Worksheet for cool roofs and SRI
Building Permit	Prescriptive	CF1R-PLB-01-E, Worksheet for hydronic heating systems
Building Permit	Prescriptive and Performance	CF1R-STH-01-E, Worksheet for OG 100 solar water heating systems
Construction	Prescriptive and Performance	CF2R-E, Certificate of Installation
Construction	Prescriptive and Performance	CF2R-H, HERS Certificate of Installation

<b>Phase</b>	<b>Method</b>	<b>Documentation Required When Applicable</b>
Field Verification and Diagnostic Testing	Prescriptive and Performance	CF3R-H, Certificate of Verification (HERS Rater)
Field Verification and Diagnostic Testing	Performance	CF3R-EXC-20-H, Certificate of Verification for Existing Conditions (HERS Rater)  Note: This document must be completed before registering the CF1R-PRF-01-E when using the performance approach for an E+A+A and verification of existing conditions.

Source: California Energy Commission

### **2.3.1 Building Permit Phase Documentation**

#### **§10-103(a)**

The compliance documentation required at the building permit phase consists of the CF1R and is based on the building plans. Depending on the compliance approach, the energy compliance documentation package may also include the area weighted average calculation worksheet (CF1R-ENV-02-E), the solar heat gain coefficient (SHGC) worksheet (CF1R-ENV-03-E), and the cool roof and SRI worksheet (CF1R-ENV-04-E). Blank copies of these worksheets are in Appendix A of this manual to use in the prescriptive compliance approach. When the performance approach is used, only the CF1R-STH worksheets are needed since the CEC-approved software performs the calculations and provides the necessary documentation contained in all other worksheets. When the performance approach is used, only the registered CF1R-PRF documents are required on the building plans.

The compliance documentation enables the plans examiner to verify that the building design shown in the plans and specifications complies with the Energy Code. It enables the field inspector to identify which building features are required for compliance and will be verified in the field.

### **2.3.2 Certificate of Compliance (CF1R)**

The Energy Code requires the CF1R to be incorporated into the plans for the building and submitted to the enforcement agency. The CF1R form identifies the minimum energy performance specifications selected by the building designer or building owner for compliance and may include the results of the heating and cooling load calculations.

To meet the requirement for filing a copy of the CF1R with the building plans for a permit application, builders/contractors should ask the enforcement agency for



information about their preferences or requirements for document submittal procedures. Most local jurisdictions may require the CF1R to be embedded in the building design computer-aided drafting (CAD) file for plotting on sheets that are the same size as the plan set sheets of the building design. Thus, the CF1R documentation would be submitted as energy compliance design sheets integral to the entire plan set for the building. Some jurisdictions may allow taping CF1R document sheets to the submitted design drawings for the building. Others may allow attaching 8½-inch x 11-inch printed CF1R document reports to the submitted design drawing package.

When the prescriptive approach is used for additions and alterations, a shorthand version of the certificate of compliance shall be submitted with the building plans or with the permit application when no plans are required. In these instances, a CF1R-ADD form is required to be submitted for additions, a CF1R-ALT-01 form is required for alterations, and a CF1R-ALT-02 form is required for HVAC changeouts. More details are in Chapter 9.

For low-rise residential buildings for which compliance requires field verification, the CF1R submitted to the enforcement agency must be a registered copy from an approved HERS data registry. More information is in the Reference Residential Appendix RA2 and Reference Joint Appendix JA7.

### 2.3.3 Construction Phase Documentation (CF2R)

#### *§10-103(a)3*

The CF2Rs are separated into envelope (CF2R-ENV), lighting (CF2R-LTG), mechanical (CF2R-MCH), plumbing (CF2R-PLB), and solar (CF2R-PVB and CF2R-STH) categories. Most compliance requirements have a separate CF2R form that is specific to a particular installation. The CF2R forms must be completed during the construction or installation phase. The documents must be completed by the applicable contractors responsible for installing regulated energy features such as windows (fenestration), the air distribution ducts and the HVAC equipment, the exhaust fans/ventilation system, the measures that affect building envelope tightness, the lighting system, and the insulation. The CF2Rs must be posted at the job site in compliance with instructions from the enforcement agency. Most typically, these forms will be with the building permit folder in a window or other accessible location.

When HERS verification of a feature is required for compliance (as shown in the HERS required certification section of the CF1R), the builder or the builder's subcontractor must perform the initial field verification or diagnostic testing of the installation to confirm and document the applicable CF2R compliance with the standards using the applicable procedures specified in Reference Residential Appendix RA3. The builder, the builder's subcontractor, or authorized representative must submit the CF2R information to an approved registry. All CF2R information submittals must be done electronically when HERS verification/testing is required.

### **2.3.4 Field Verification and Diagnostic Testing Documentation (CF3R)**

#### **§10-103(a)5**

Within the Energy Code, some mandatory requirements, some prescriptive requirements, and some requirements that may be used for compliance credit in the performance approach may require field verification or diagnostic testing or both. This testing must be performed by a HERS Rater who is specially trained and independent from the builder or general contractor.

When HERS verification is required, the HERS Rater must complete, register, and sign/certify the CF3R. The CF3R documents include information about the measurements, tests, and field verification results that were required to be performed. The HERS Rater must verify that the requirements for compliance have been met.

The HERS Rater chosen for the project must transmit the CF3R information to an approved HERS registry. This must be the same HERS registry through which the previous compliance documents (CF1R, CF2R) for the project were registered. The HERS Rater used for the project must be certified by the HERS provider. A registered CF3R is made available to the enforcement agency and the builder when HERS testing confirms compliance. The builder ensures that the enforcement agency has received the CF3R. The enforcement agency cannot issue the certificate of occupancy before receiving all required compliance documents, including the CF3Rs.

The HERS Rater shall provide a separate registered CF3R form for each house that the HERS Rater determines has passed the HERS verification performed for compliance. The rater shall not sign a CF3R for a house that does not have a registered CF2R that has been signed/certified by the installer. The only exception is for homes or projects within a sample group.

Sampling is a process wherein a builder or contractor may coordinate with a HERS Rater to allow the HERS verification for one home or project stand for all homes or projects within the sample group. Sample groups may include similar homes or projects from one builder, contractor, or installer for a particular HERS verification. For example, an HVAC contractor, after installing or replacing a ducted HVAC system, may request up to seven existing homes in one sample group. Working with one HERS Rater, the contractor will test only one of the seven homes for fan watt draw, duct air leakage, and refrigerant charge. If it passes, the HERS verification on this one home will stand for all seven installations in the sample group.

If the building was included in a sample group, the CF3R will identify whether the requirement passed compliance by testing or by sampling. The CF3R form for the tested home of a sample group will include the HERS test results, but the untested homes will not. CF3Rs for tested and untested homes in a sample group will still have a registration number, date, time, and watermark of the HERS provider's seal as any other CF3R that is not included in sampling. Refer to Reference Residential

Appendix RA2 for more details on HERS verification and CF3R documentation procedures.

### **2.3.5 Compliance, Operating, Maintenance, and Ventilation Information to Be Provided by Builder**

#### ***§10-103(b)***

The final documentation in the process is the information that is provided to the homeowner. At the completion of construction and before occupancy (for newly constructed homes and additions) and before final inspections (for alterations), the enforcement agency will require the builder to leave in the building the applicable completed, signed, and dated compliance documentation. Provide at a minimum, the applicable CF1R forms, CF2R forms, and, if compliance required HERS verification, the applicable CF3R forms. When registration is required, these compliance documents shall be registered copies. In addition to the compliance documentation, the builder must leave in the building operating and maintenance information for all installed features, materials, components, and manufactured devices. The operating and maintenance information must contain the details needed to provide the building owner/occupant with instructions on how to operate the home in an energy-efficient manner that ensures satisfactory indoor air quality and to maintain it so that it will continue to work efficiently. Paper or electronic copies of these documents are acceptable.

---

**Example 2-1****Question**

What are the plan check and field inspection requirements related to the CF2R?

**Answer**

A CF2R (certificate of installation) is not submitted with compliance documentation at the time of permit application. It is posted or made available for field inspection after installation of an applicable feature. A field inspector should review the "Required Special Features" on the CF1R, then check for the equipment and characteristics that are actually installed against what is reported on the CF2Rs. The field inspector should do this for all installed building components indicated on a CF2R (HVAC, fenestration, insulation, water heating, and so forth).

When HERS verification is required for compliance, the field inspector should review the "HERS Features Summary" on the CF1R to identify the required installer tests and confirm that these tests were performed and documented on the applicable CF2Rs.

Any required forms will be indicated on the HERS registry in the project status report (PSR) for the residence.

The enforcement agency may request additional information to verify that the installed efficiency requirements are consistent with the approved plans and specifications. When material properties or equipment efficiencies greater than the minimum requirements are shown on the CF1R, the enforcement agency may have procedures for verifying the actual material or equipment specifications. For example, the enforcement agency may require the installer to provide a copy of the applicable page(s) from a directory of certified equipment.

**Example 2-2****Question**

What happens to the CF2R after the final inspection?

**Answer**

§10-103(b) requires the builder to leave a copy of the CF2R in the building for the building owner at occupancy.

**Example 2-3****Question**

As a general contractor, when I have finished building a home, is there a list of materials I am supposed to give to the building owner?

**Answer**

Section 10-103(b) requires that at final inspection the enforcement agency shall require the builder to leave compliance, operating, maintenance, and ventilation information in the building for the "building owner at occupancy," which includes the:

1. Certificate of compliance (CF1R).

2. Certificate(s) of installation (CF2R).
  3. Certificate(s) of verification (CF3R) if applicable.
  4. Operating information for all applicable features, materials, components, and mechanical devices installed in the building.
  5. Maintenance information for all applicable features, materials, components, and manufactured devices that require routine maintenance for efficient operation.
- 

## **2.4. Roles and Responsibilities**

### **2.4.1 Designer**

*5537 and 6737.1 of California Business and Professions Code*

The designer is responsible for the overall building design. The designer specifies the building features that determine compliance with the Energy Code and other applicable building codes. The designer is required to sign the certificate of compliance (CF1R) to certify that the building complies with the Energy Code.

The designer may personally prepare the documents or delegate preparation of the energy analysis and certificate of compliance documents to an energy documentation author or energy consultant. If preparation of the compliance documentation is delegated, the designer must remain in charge of the building design specifications, energy calculations, and all building feature information represented on the certificate of compliance. The designer's signature on the certificate of compliance affirms his or her responsibility for the information submitted.

The designer may be an architect, engineer, or other California-licensed professional; however, a licensed design professional may not always be required for single-family residential buildings. *The California Business and Professions Code* allows unlicensed designers to prepare design documentation for wood-framed single-family residential buildings if the dwellings are no more than two stories high, not counting a possible basement. For homes that do not require a licensed design professional, the builder may sign the CF1R in the "Responsible Building Designer" signature block.

When the designer is a licensed professional, the signature block on the certificate must include the designer's license number. When registration is required, the certificate of compliance must be submitted to an approved HERS data registry. All submittals to the registry must be made electronically.

## 2.4.2 Documentation Author

### a. §10-103(a)1

The person who designs the building may delegate the energy analysis and preparation of the certificate documentation to a building energy consultant or documentation author. A completed CF1R must be submitted to the enforcement agency during the building permit phase. The certificate demonstrates to the enforcement agency plan examiner that the building design complies with the Energy Code. The information submitted on the CF1R must be consistent with the building design features in the plans and specifications for the building submitted to the enforcement agency.

The documentation author is not subject to the same limitations and restrictions of the *Business and Professions Code* as is the building designer because the documentation author is not responsible for specification of the building design features. The documentation author may provide the building designer with recommendations for building energy features. If building designer approves the recommendations, the features must be incorporated into the design plans and specification documents submitted to the enforcement agency at plan check. The documentation author's signature on the certificate of compliance certifies that the documentation is accurate and complete but does not indicate documentation author responsibility for the specification of the features that define the building design. The documentation author provides completed certificate of compliance documents to the building designer, who must sign the certificate before submitting it to the enforcement agency at plan check.

If registration of the CF1R is required, it must be submitted to the registry and signed electronically by both the designer and documentation author before submitting to the enforcement agency. When document registration is required, only registered certificates of compliance that display the registration number assigned to the certificate by an approved HERS registry are acceptable for submittal to the enforcement agency at plan check.

A list of recommended documentation authors is at the California Association of Building Energy Consultants' (CABEC), [CABEC Homepage](https://cabec.org/) (<https://cabec.org/>).

## 2.4.3 Builder or General Contractor

Chapter 9 of the *Business and Professions Code* specifies the term "contractor" is synonymous with the term "builder." This manual uses "builder" to refer to the general contractor responsible for construction. For additions and alterations to existing homes, the contractor can act as the builder or general contractor (typically for smaller projects). For production homes, the builder may also be the developer responsible for arranging financing, acquiring the land, subdividing the property, securing the necessary land planning approvals, and attending to the other necessary tasks that are required before actual construction. Many production builders are involved in marketing and sales of homes after they are constructed.

During construction, the builder or general contractor usually hires specialty subcontractors to provide specific services, such as installing insulation, designing, and installing HVAC systems, installing windows and skylights, installing water heating systems, and others. For homes that do not require a licensed design professional, the builder may sign the CF1R in the "Responsible Building Designer's" signature block.

The builder or general contractor must ensure that CF2Rs are submitted to the enforcement agency by the person(s) responsible for the construction/installation of regulated features, materials, components, or manufactured devices. The builder or general contractor may sign the CF2R on behalf of the specialty subcontractors they hire, but the preparation and signature responsibility reside with the specialty subcontractor who provided the installation services. The CF2R identifies the installed features, materials, components, or manufactured devices detailed in the plans and specifications, and the CF1R approved by the enforcement agency. If the installation requires HERS verification, the CF2R must report the results of the installer's testing of the regulated installations to measure performance. The CF1R and the CF2R shall be submitted to an approved HERS registry. A copy of the registered CF2R is required to be posted at the building site for review by the enforcement agency in conjunction with requests for intermediate and final inspections.

When the Energy Code requires registration of the compliance documents, the builder or general contractor must ensure the transmittal/submittal of the required information to an approved HERS registry. The builder or general contractor must arrange for the services of a certified HERS Rater if the CF1R indicates that HERS verification is required. The builder or general contractor must ensure that a copy of the CF1R that was approved by the designer/owner and submitted to the enforcement agency during the permitting phase is transmitted to the HERS registry. The CF1R should be made available to the HERS Rater, who will perform any required HERS testing.

When installation is complete, the builder or general contractor must ensure that the persons responsible for the installation have transmitted/submitted the required CF2R information to the registry. The builder must ensure that the HERS Rater receives a copy of the completed CF2R or provide access to the HERS registry that has been registered and signed by the builder or subcontractors responsible for the installation. When registration of the CF2R is required, the completed and signed copies that are posted at the building site for review by the enforcement agency, in conjunction with requests for final inspection, are required to be registered copies.

At final inspection, the builder or general contractor is required to leave in the building all applicable completed, signed, dated, and registered (when applicable) compliance documents (CF1R, CF2R, and CF3R if applicable) for the building owner at occupancy. These forms must be in paper or electronic format and must conform to the applicable requirements of §10-103(a).

## 2.4.4 Specialty Subcontractors

Specialty subcontractors provide the builder with services from specific building construction trades for installation of features such as wall and ceiling insulation, fenestration, HVAC and air distribution, or water heating and plumbing. These subcontractors may perform other trade-specific specialty services during building construction. The builder is responsible for all aspects of building construction and has the authority to complete and sign/certify all sections of the required CF2Rs. The licensed specialty subcontractor, however, should be expected to complete and sign/certify all applicable CF2Rs that document the completion of the work they have performed. The subcontractor's responsibility for documentation should include providing a registered (when applicable) and signed copy of all applicable CF2Rs to the builder and posting a registered (when applicable) and signed copy of all applicable CF2R at the building site for review by the enforcement agency. The subcontractors should make the registered and signed copies of the applicable CF2Rs available to the HERS Rater if HERS verification is required for compliance, as specified on the CF1R or any CF2R.

When the Energy Code requires document registration, all copies of the CF2Rs submitted to the builder, the enforcement agency, and the HERS Rater are required to be registered copies prepared by following the procedures in Reference Residential Appendix RA2, Reference Joint Appendix JA7, and Section 2.3 of this manual.

## 2.4.5 Enforcement Agency

### *§10-103*

The enforcement agency is the authority having jurisdiction (AHJ) to issue building permits and verify compliance with applicable codes and standards (including the Energy Code). The agency performs several key roles in compliance and enforcement.

### 2.4.5.1 Plan Check

The enforcement agency performs plan check review of the CF1R and the plans and specifications that define the building design submitted to the enforcement agency at the building permit phase. During the plan check, the agency compares CF1R to the plans and specifications for the building design to confirm that the building features are specified consistently in all the submitted documents. If the specification for design features on the CF1R does not conform to the specifications on the designer's submitted plans and specifications for the building, the designer must revise the submitted documents to make the design specification consistent in all documents.

If the CF1R indicates the building complies, and it is consistent with the features on the plans and specifications for the building design, then the plan check can confirm that the design complies with the Energy Code. If the enforcement agency determines that the building design complies with the Energy Code, in addition to all



the other applicable codes and standards, it may issue a building permit. When the Energy Code requires document registration, the CF1R submitted for a plan check must be a registered document from an approved HERS registry. The one exception is the CF1R-ALT-02-E for HVAC changeouts. If approved by the enforcement agency, permit applicants may use unregistered CF1R-ALT-03-E or CF1R-ALT-04-E documents (dependent upon climate zone) to apply for permits and present the registered CF1R-ALT-02-E to the inspector at the time of the final permit.

#### **2.4.5.2 Construction Inspection**

During building construction, the enforcement agency should make several visits to the construction site to verify that the building is being constructed in accordance with the approved plans, specifications, and CF1R. At each site visit, the agency should review any applicable CF2Rs that have been posted or made available with the building permit(s). The enforcement agency should confirm that the energy efficiency features installed in the house are consistent with the requirements given in the CF1R for the building approved during plan check, that the installed features are described accurately on the CF2R, and that all applicable sections of the CF2R have been signed by the responsible licensed person(s). The enforcement agency should not approve a dwelling unit until it has received the applicable certificate(s). When the Energy Code requires registration of the energy compliance documents, the CF2R must be registered with an approved HERS registry.

#### **2.4.5.3 Corroboration of Field Verification and Diagnostic Testing Procedures**

As described in Reference Residential Appendix Section RA2.4.4, at its discretion, the enforcement agency may require that HERS verification by the builder or subcontractors or the HERS Rater be scheduled so that the enforcement agency's field inspector can observe the HERS verification procedures to corroborate the results reported on the CF2R and CF3R.

#### **2.4.5.4 Sampling Within Enforcement Agency Jurisdictions**

When sampling is used for HERS testing for newly constructed buildings, all dwellings in a designated sample group must be located within the same enforcement agency jurisdiction and subdivision as specified in Reference Residential Appendix Section RA2.6.3.1

When sampling is used for HERS testing for alterations, the dwellings in a designated sample group are not required to be located within the same enforcement agency jurisdiction. They are required to have the same installing contractor and must be assigned to the same rater. The building owner may choose for the HERS verification to be completed as part of a designated sample group composed of dwelling units for which the same installing company has completed the work that requires HERS testing, as specified in Reference Residential Appendix Section RA2.8. However, to enable the enforcement agency to schedule testing to accomplish the corroboration described in the previous section, it may choose to

require that a separate dwelling unit from the sample group that is located within the respective jurisdiction be tested.

#### 2.4.5.5 **Final Approval**

The enforcement agency may approve the dwelling at the final inspection phase if all field inspections have determined all of the following:

- The dwelling conforms to the requirements of the plans and specifications as approved by the enforcement agency.
- The dwelling conforms with the CF1R approved by the enforcement agency.
- The dwelling conforms with all other applicable codes and standards requirements.
- The enforcement agency is in receipt of all CF2R required by the Energy Code and as identified by the CF1R for the dwelling unit.
- The CF1R and CF2R are signed and registered (when applicable) by the builder or subcontractor.
- For dwelling units requiring HERS testing, the enforcement agency has received a copy of the CF3R as registered with a HERS register
- The CF3R has been signed and dated by the HERS Rater.

The builder must ensure that all such required energy compliance documentation has been completed properly and posted at the job site or submitted to the enforcement agency in conjunction with the required inspections. However, the enforcement agency, in accordance with §10-103(d), as a prerequisite to approval of the building, must examine all required copies of the CF1R, CF2R, and CF3R posted at the site or made available with the building permits for the required inspections. This examination confirms that these compliance documents have been properly prepared and are consistent with the plans and specifications approved by the enforcement agency.

When an alteration has been performed by a participating Third Party Quality Control Program (TPQCP) contractor (see Section 2.4.8 of this manual), the enforcement agency may conditionally approve the building based on the CF2Rs if the TPQCP data checking has indicated that the installation complies. However, if subsequent HERS testing determines that resampling, full testing, or corrective action is necessary for such conditionally approved dwellings in the group, the corrective work must be completed and tested. Additional information is in Reference Residential Appendix RA2.4.3, RA2.7, and RA2.8.

#### 2.4.5.6 **Corroboration of Information Provided for the Owner/Occupant**

At final inspection, the enforcement agency shall require the builder to leave in the building (for the building owner at occupancy) Energy Code compliance documents, operating and maintenance manuals, and ventilation information, as specified by §10-103(b).

Compliance documents for the building shall include all valid certificates of compliance (CF1R), certificate of installation (CF2R), and certificate of verification (CF3R). These documents must conform to the applicable requirements of §10-103(a).

Operating information shall include instructions on how to operate or maintain the energy features, materials, components, and mechanical devices of the building correctly and efficiently. Such information shall be in a folder or otherwise bound to provide all information in §10-103(b). This operating information shall be in paper or electronic format. For dwelling units, buildings, or tenant spaces that are not individually owned and operated, or are centrally operated, such information shall be provided to the person(s) responsible for operating the feature, material, component, or mechanical device installed in the building. This information shall be in paper or electronic format.

Maintenance information shall be provided for all features, materials, components, and manufactured devices that require routine maintenance for efficient operation. Required routine maintenance actions shall be clearly stated and incorporated on a readily accessible label. The label may be limited to identifying, by title or publication number, the operation and maintenance manual for that particular model and type of feature, material, component, or manufactured device. For dwelling units, buildings, or tenant spaces that are not individually owned and operated, or are centrally operated, such information shall be provided to the person(s) responsible for maintaining the feature, material, component, or mechanical device installed in the building. This information shall be in paper or electronic format.

Ventilation information shall include a description of the quantities of outdoor air that the ventilation system(s) are designed to provide to the conditioned space of the building, and instructions for proper operation and maintenance of the system. For buildings or tenant spaces that are not individually owned and operated, or are centrally operated, such information shall be provided to the person(s) responsible for operating and maintaining the feature, material, component, or mechanical ventilation device installed in the building. This information shall be in paper or electronic format.

---

**Example 2-5****Question**

We are an enforcement agency with jurisdiction over the replacement of the outdoor compressor/condenser unit of an HVAC unit (an alteration), and the HVAC contractor who pulled the permit for replacing the unit has requested that we approve the final inspection and close out the permit based only on the certificate of installation (CF2R) for this job. This job requires HERS verification, and I thought it was necessary to receive the HERS Rater's completed and signed certificate of verification (CF3R) before the job could comply as a condition to final approval of the installation. Is there an allowance for compliance based only on the CF2R?

**Answer**

Yes. The enforcement agency may provide a conditional final approval of the installation based upon the CF2R for alterations jobs only, and only if the installing contractor is an approved Third Party Quality Control Program (TPQCP) installing contractor. The conditional final approval is allowed if TPQCP data checking has scrutinized the diagnostic test data submitted by the approved contractor's diagnostic test for the installation, and such data checking indicates the installation complies as shown on the CF2R.

The permittee is still required to complete all HERS verification procedures and comply with all HERS verification criteria. A CF3R is still required to be submitted to the enforcement agency, builder, and homeowner for the documentation procedure to be complete. If HERS verification of the approved TPQCP contractor's installation work determines that resampling, full testing, or corrective action is necessary to bring the installation into compliance, such work must be completed before issuing the CF3R. Sampling procedures for HERS verification for installation work performed by an approved TPQCP contractor allows testing of one sample from a designated group of up to 30 dwellings for which the work was performed by the same approved TPQCP installing contractor. Refer to Reference Residential Appendix Sections RA2.4.3, RA2.7 and RA2.8 (and Chapter 9 of this manual) for additional information.

---

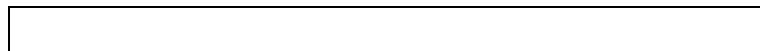
**2.4.6 HERS Provider**

A HERS provider is an organization that the CEC has approved to administer a HERS program. The provider certifies, trains, and oversees HERS Raters. HERS Raters provide HERS verification on installed energy efficiency features in dwellings when required for compliance with the Energy Code. Visit the CEC website for the list of approved HERS providers at <http://www.energy.ca.gov/HERS/>

The HERS provider must also maintain a HERS registry that incorporates a website-based user interface that accommodates the needs of the authorized users of the data registry who administer HERS compliance document registration. The HERS registry must receive, and record information required by HERS testing in a specific

dwelling. The HERS registry must have the capability to verify that the recorded information complies with the XML schema developed by the CEC. When the input data are verified, the HERS registry must make available a unique registered certificate available to authorized users. These registered certificates (CF1R, CF2R, and CF3R) are used in complying with document submittal requirements to local enforcement agencies, builders, building owners, HERS Raters, and other interested parties. The HERS registry helps simplify electronic submittal of the registered certificates to an CEC document repository for retention of the certificates for use in regulations enforcement.

The HERS provider must make available (via phone or Internet communications interface) a way for authorized users of the registry to verify the information displayed on copies of registered documents. Refer to Reference Residential Appendices Section RA2.4.2 and Reference Joint Appendix JA7 for additional information.

#### **2.4.7 HERS Rater**

The HERS Rater is trained and certified by a CEC-approved HERS provider to perform the HERS verification that may be required to demonstrate and document compliance with the Energy Code. HERS Raters receive special training in diagnostic techniques and building science as part of the certification administered by the HERS providers. The HERS Raters operate independently from the HERS providers and are to act as independent, third-party agents to the project contractor installing the energy efficiency requirements for the construction project. HERS Raters shall be considered “special inspectors” by enforcement agencies, which is not to be confused with the same term used by local enforcement agencies regarding inspectors with specific ICC training and certification. HERS Raters are not special inspectors for the local enforcement agencies; they are special inspectors for the project proponents, including the installing contractor. HERS Raters may be required to attain business licenses in some jurisdictions.

The CEC has determined that a HERS Rater may act as a document author for the CF2R for a residential project with no violation of the provisions of “Conflict of Interest” (Title 20, Section 1673[j]). If requested to do so by the builder or subcontractor, the HERS Rater may aid the builder or subcontractor register the CF2R with a HERS registry. However, the HERS Rater may not certify the information on a CF1R as the responsible person (that is, sign the CF1R as if they were the builder or subcontractor).

The builder or subcontractor responsible for the installation must provide the certification by electronic signature to confirm the information submitted to the registry. Refer to Reference Residential Appendix Section RA2.5 and Reference Joint Appendix JA7 for more information. The HERS Rater may not certify the information on a CF2R as the responsible person, unless the rater and installer have signed a written agreement that the Rater is an authorized representative that may sign on

behalf of the installer. The installing contractor remains the responsible person. Qualifications for delegation of signature authority are detailed in §10-103(a)3A.

The HERS Rater conducts the HERS verification of the installed energy efficiency features when required by the CF1R or CF2R. The HERS Rater must transmit the results of the HERS verification to the HERS registry. The HERS Rater must provide to the registry all information required to complete the CF3R and must certify those data as accurate and complete to the registry. The registry will make available registered copies of the CF3R to authorized users. Printed copies, electronic or scanned copies, and photocopies of the completed, signed, and registered CF3R are allowed for document submittals, subject to verification that the information contained on the copy conforms to the registered document information on file in the registry for the dwelling. A copy of the registered CF3R must be posted at the building site or made available to the inspector for review by the enforcement agency in conjunction with requests for final inspection for each dwelling unit.

Go to Reference Residential Appendix Section RA2.4.2 for more information.

---

### Example 2-6

#### **Question**

Can a certified HERS Rater who performs and registers the HERS testing for a dwelling also perform the HERS verification required of the builder or installer to certify compliance with the Title 24, Part 6, installation requirements on the CF2R?

#### **Answer**

Yes. This approach is allowed when the HERS Rater is doing HERS verification for every dwelling (100 percent testing), but it is not allowed when the HERS Rater performs verification using a designated sample group of dwellings.

When 100 percent testing is used for HERS verification, the builder or the installer may use the information from the HERS Rater's HERS test results when completing the CF2R. When doing so, builders or installers signing the certification statement on the CF2R are assuming responsibility for the information in the form and are certifying that the installation conforms to all applicable codes and regulations. The HERS Rater may sign using the installer's delegated signature authority but cannot be assigned the responsibilities of the builder or installer, as stated on the CF2R and as prescribed by the Energy Code. Refer to §10-103(a)3A for authorized representation.

If the HERS Rater determines that the compliance requirements are not met (in other words, the HERS verification results in a failure), the HERS Rater will submit the data of the failed HERS testing into a HERS registry for retention. The builder or installer must make the needed corrections. Once corrections have been made and the HERS Rater determines that all compliance requirements are met, the builder or installer may certify the work by completing and signing the applicable section of the CF2R. The HERS Rater can complete the CF3R documentation for the dwelling.

## Example 2-7

**Question**

I heard that there are conflict of interest requirements that HERS Raters must abide by when doing HERS verification. What are these requirements?

**Answer**

Raters are expected to be objective, independent third parties as field verifiers and diagnostic testers. By law, raters must be independent from the builder or subcontractor installer of the energy efficiency features being tested and verified. They can have no financial interest in the installation of the improvements. Raters cannot be employees of the builder or subcontractor whose work they are verifying. Also, they cannot have a financial interest in the builder's or contractor's business or advocate or recommend the use of any product or service that they are verifying.

The CEC expects HERS Raters to enter into a contract with the builder (not with subcontractors) to provide independent, third-party HERS verification. The procedures adopted by the CEC call for direct reporting of results to the HERS registry where the project has been established by the builder. Although not recommended by the CEC, a three-party contract among builder, rater, and subcontractor is possible, provided that the contract delineates the independent responsibilities of the HERS Rater and the responsibilities of a subcontractor to take corrective action in response to deficiencies found by a HERS Rater. Such contracts may also establish the role for a subcontractor to serve as administrator for the contract, including scheduling the HERS Rater, invoicing, and payment, provided the contract ensures that money paid by the builder to the HERS Rater can be traced through an audit. It is critical that such contractors preserve the HERS Rater's independence in carrying out the responsibilities specified in CEC-adopted HERS testing procedures. Even though such contracts do not violate the conflict of interest requirements, the closer that the working relationship is between the HERS Rater and the subcontractor whose work is being inspected, the greater the potential for compromising the HERS Rater's independence.

Compliance cannot be shown using sampling if a three-party contract is used. One hundred percent of homes must be tested by a HERS Rater when a three-party contract is used. HERS Raters must use their own diagnostic equipment and not the installing contractor's equipment when verifying work performed when a three-party contract is used.

HERS providers must provide ongoing monitoring of the propriety and accuracy of HERS Raters in the performance of their duties and to respond to complaints about the HERS Rater's performance. Where there may be real or perceived compromise of the HERS Rater's independence, the HERS provider is responsible for increasing scrutiny of the HERS Rater and acts to ensure objective, accurate reporting of HERS testing results in compliance with the Energy Code.

Enforcement agencies have authority to require HERS Raters to demonstrate their competence to the satisfaction of the building official. When the HERS Rater's independence is in question, building officials can prohibit a particular HERS Rater from being used in their jurisdiction or disallow practices that the building official believes will compromise the HERS Rater's independence. Building officials may require the use of a three-party contract. For additional information please contact the CEC Hotline.

---

### **2.4.8 Third Party Quality Control Program**

A Third Party Quality Control Program (TPQCP) is a service that verifies the work of participating installers by gathering extensive diagnostic data and flagging potentially noncompliant installations.

The CEC may approve TPQCPs that serve some of the functions of HERS Raters HERS verification but do not have the authority to sign compliance documentation as a HERS Rater. A TPQCP:

- A. Trains installers, contractors, technicians, and specialty subcontractors about compliance requirements for features that require field verification and diagnostic testing.
- B. Collects more data than would be required to demonstrate compliance with the Energy Code from participating installers for each installation.
- C. Performs validation and analysis of information from diagnostic HERS verification performed on a participating contractor's installation work to evaluate the validity and accuracy of the data and independently determine whether compliance has been achieved.
- D. Provides direction to the installer to retest and correct problems when data checking indicates that compliance has not been achieved.
- E. Requires submission of data when retesting and correction are directed.
- F. Maintains a database of all data submitted by the participating TPQCP contractor in a format that is acceptable and made available to the CEC upon request.

The HERS provider must arrange for an independent HERS Rater to conduct independent HERS verification of the installation performed by the participating TPQCP contractor. If a group sampling is used for HERS verification for jobs completed by a participating TPQCP contractor, the sample from the group that is tested for compliance by the rater may be selected from a group composed of up to 30 dwellings for which the same participating contractor has performed the installation. For alterations, the installation performed by TPQCP contractors may be approved at the enforcement agency's discretion and on the condition that, if subsequent HERS verification determines that resampling, full testing, or corrective action is necessary for such conditionally approved dwellings in the group, the corrective work must be completed.



Refer to Reference Residential Appendix RA2.4.3, RA2.7, and RA2.8 for additional information.

### **2.4.9 Owner**

“Building owner” refers to the owner of the dwelling unit. For production homes, the owner is the builder or the person(s) that buys the new home. In custom homes and remodels, the owner may be the homeowner, builder, developer, a general contractor, architect, or engineer.

As part of the compliance process, the owner must receive compliance, operating, maintenance, and ventilation information documents at the time of occupancy. The enforcement agency must require the builder to leave this information in the building for the building owner at occupancy as specified in §10-103(b). This requirement applies to newly constructed homes, additions, and alteration to an existing home. The exact compliance, operational, maintenance, and ventilation documents are based on the scope of the construction project.

---

#### Example 2-8

##### **Question 1**

What is my responsibility with respect to the CF2R (certificate of installation) as the enforcement agency inspector?

##### **Answer 1**

The field inspector for the enforcement agency has two general responsibilities, according to the Energy Code (§10-103[d]2):

The CF2Rs and CF3Rs (if applicable) are all consistent with the CF1Rs, plans, specifications, and change orders as approved by the enforcement agency. These include all installed features, materials, components, or manufactured devices regulated by the Appliance Efficiency Regulations or the Energy Code as indicated on the CF1Rs.

All required CF2Rs and CF3Rs are completed, signed, and posted or made available with the permit issued for the construction project.

The CF2Rs and CF3Rs (if applicable) are all consistent with the CF1Rs, plans, specifications, and change orders as approved by the enforcement agency. This includes all installed features, materials, components, or manufactured devices regulated by the Appliance Efficiency Regulations or the Energy Code as indicated on the CF1Rs.

All required CF2Rs and CF3Rs are completed, signed, and posted or made available with the permit issued for the construction project.

While the compliance documents (CF1R, CF2R, and CF3R) are required to be submitted to the enforcement agency, the agency is not required to use the compliance documents in any way.

The CEC recommends that the inspector verify CF2R during the applicable site inspections. For example, verify the CF2R for quality insulation installation during the framing, air sealing, and insulation inspections. Do not wait until the final inspection to check all CF2R documentation.

## Question 2

What is my responsibility with respect to the CF2R (certificate of installation) as a builder?

## Answer 2

The general contractor is responsible for completing and signing the CF2R form for the work performed. A homeowner acting as the general contractor for a project is authorized to sign the CF2R. The installing contractor should provide the CF2R since the certification statement is an installer's assurance to the owner that the work has been completed properly and complies with applicable codes and regulations. The CF2R certification statement and signature indicates that the equipment or feature 1) was installed properly and confirms that the information provided on the form properly identifies the installed building component or equipment, 2) is equivalent or more efficient than required by the approved plans (as indicated on the CF1R), and 3) meets all relevant certification or performance requirements.

Refer to §10-103(a)3 for more information about certificate of installation requirements.

---

## 2.5. HERS Field Verification and Diagnostic Testing

This section describes some procedures and requirements for HERS verification of energy efficiency features.

HERS testing is performed by HERS Raters who are trained and certified to perform these services. The HERS Raters cannot be employees of the builder or contractor whose work they are verifying. Also, they cannot have a financial interest in the builder's or contractor's business, or advocate or recommend the use of any product or service that they are verifying. The training, quality assurance, and general oversight of the HERS Raters are conducted by HERS providers.

### 2.5.1 Measures Requiring HERS Field Verification and Diagnostic Testing

HERS verification is required only when certain regulated efficiency requirements or equipment features are installed. If such efficiency requirements or equipment features are not installed, then HERS verification is not required. For example, if a dwelling that must comply with the Energy Code does not have air distribution ducts, then HERS verification for duct leakage is not required for compliance.

The following features require HERS verification:

- Duct sealing

- Duct location, surface area, and R-value
- Low-leakage ducts entirely in conditioned space
- Low-leakage air handlers
- Verification of return duct design
- Verification of air filter device design, filter MERV rating, and labeling
- Verification of prescriptive bypass duct requirements
- Refrigerant charge in ducted split-system and ducted packaged unit air conditioners and heat pumps, and mini-split systems
- Refrigerant fault indicator display (FID)
- Verified system airflow
- Air handler fan efficacy
- Verified energy efficiency ratio (EER)
- Verified seasonal energy efficiency ratio (SEER)
- Heat pump-rated heating capacity
- Evaporatively cooled condensers
- Variable-capacity heat pump credit
- Whole-house fan
- Central fan ventilation cooling systems
- Continuous whole-building mechanical ventilation airflow
- Intermittent whole-building mechanical ventilation airflow
- Kitchen exhaust (including vented range hoods)
- Building envelope air leakage
- Quality insulation installation (QII)
- Quality insulation installation for spray polyurethane foam
- Verified pipe insulation credit (PIC-H)
- HRV/ERV system fan efficacy
- Verified central parallel piping (PP-H)
- Verified compact hot water distribution system expanded credit (CHWDS-H-EX)
- Demand recirculation: manual control (R-DRmc-H)
- Demand recirculation: sensor control (R-DRsc-H)
- Multiple recirculation loop design for DHW systems serving multiple dwelling units
- Verified drain water heat recovery system (DWHR-H)

## **2.5.2 Verification, Testing, and Sampling**

At the builder's option, HERS testing may be completed for each dwelling unit (100 percent testing) or for a group of dwelling units (sampling). Sampling for newly constructed units is permitted only when multiple dwelling units of similar design are constructed within the same subdivision by the same subcontractor. Sampling may also be used, at the builder's or installer's option, for alterations for groups composed of dwellings having the same requirements installed that require HERS testing, and where the same installing contractor has installed the requirements. More details are in Reference Residential Appendix Section RA2.6 and RA2.8.

To be included in a sample group, the builder or subcontractor must provide the HERS Rater with a copy of the registered CF1R and CF2R as specified in Reference Residential Appendix Section RA2.5. The building owner or installer must give the HERS Rater project access on the registry to facilitate planning and execution of sampling.

The installer must self-test every requirement and sign as the responsible person on the appropriate CF2Rs. The HERS Rater may test a representative home (referred to as the "model") to help the installer identify any issues before self-testing the remaining homes. See Section 2.5.3.

Prior to performing any HERS verification, the HERS Rater must confirm that the CF1R and CF2Rs have been registered for each dwelling unit to be tested. It is the HERS Rater that facilitates dwelling unit grouping without direction from the installer or builder. The HERS Rater also chooses the first of each type of HERS requirement to test without any forewarning.

The HERS Rater will transmit all test results to the registry and sign as the responsible person on the CF3Rs. The HERS provider will make available a registered copy of the completed and signed CF3Rs to all approved authorized users of the registry. Printed copies, electronic or scanned copies, and photocopies of the registered CF3Rs will be allowed for document submittals, subject to authentication between the copy and the registered certificate. A registered copy of the CF3R must be posted at the building site or made available for review by the enforcement agency in conjunction with requests for final inspection for each dwelling unit.

The HERS provider will make available, via phone or Internet, a way for authorized users of the HERS registry to verify that the information displayed on copies of registered documents on file in the registry for the dwelling unit.

If the builder chooses the sampling option, the procedures in Reference Residential Appendix Sections RA2.6 and RA2.8 must be followed.

## **2.5.3 Initial HERS Testing for Subdivision Projects**

The HERS Rater must perform the required HERS verification on the first dwelling unit of each model within a subdivision. To be considered the same model, dwelling units must have the same basic floor plan layout, energy design, and compliance

features as shown on the CF1Rs. Variations in the basic floor plan layout, energy design, compliance features, zone floor area, or zone volume that do not change the features to be verified, the heating or cooling capacity of the HVAC unit(s), or the number of HVAC units specified for the dwelling units will not cause dwelling units to be considered a different model.

The initial model HERS verification allows the builder to identify and correct any potential construction flaws or practices in the build-out of each model. If HERS verification determines that the requirements for compliance are met, the HERS Rater will transmit the HERS verification results to the HERS registry.

#### **2.5.4 Group Sample HERS Testing for Subdivisions**

After the initial model HERS verifications are completed, the builder or the builder's authorized representative determines which sampling procedure is to be used for the group of dwellings that require HERS testing. There are two procedures for HERS testing using group sampling: (1) sampling a closed group of up to seven dwellings and (2) sampling of an open group of up to five dwellings. The group sampling requirements for each procedure will be discussed in this section. If available, a TPQCP allows up to 30 dwelling units to be grouped.

Transmittal/submittal of the CF2R information, for at least one dwelling, to the HERS registry is required to open a new group. Additional dwellings may be entered into the registry and included in an "open" group over a specific period, subject to transmittal/submittal of the CF2R to the registry for each additional dwelling. However, the group shall not remain open to receive additional dwellings for a period longer than six months from the earliest date shown on any CF2R for a dwelling included in a group. A group may be closed at any time after the group has been opened at the option of the builder or builder's authorized representative. The size of a closed group may range from a minimum of one dwelling to a maximum of seven dwellings. When a group is closed, no additional dwellings shall be added to the group.

- A. Sampling of a closed group of up to seven dwellings requires the following conditions to be met as prerequisite to receiving CF3R for the group:
1. All the dwelling units in the sample group have been identified. Up to seven dwellings are allowed to be included in a closed sample group.
  2. Installation and diagnostic testing of all the features that require HERS verification have been completed by the installer in all dwellings in the group, and all CF2Rs are registered.
  3. The group has been classified as a closed group in the data registry.
  4. At the request of the builder or the builder's authorized representative, a HERS Rater will randomly select one dwelling unit from the closed sample group to begin HERS verification. If the dwelling unit meets the compliance requirements, this tested dwelling and each of the other nontested dwellings

in the group will receive a registered certificate of verification. Alternatively, the rater may test and verify requirements in different dwelling units in the group.

- B. Sampling of an open group of up to five dwellings requires the following conditions to be met as prerequisite HERS verification on the group:
1. At least one dwelling unit from the sample group has been identified. Up to five dwellings are allowed to be included in an open sample group.
  2. Installation of all the features that require HERS testing shall be completed by the installer in all dwellings. Registration of the CF2Rs for all the dwellings has been completed.
  3. At the request of the builder or the builder's authorized representative, a HERS Rater will randomly select one dwelling unit from the open sample group for HERS verification. If the dwelling unit meets the compliance requirements, the tested dwelling and each of the other nontested dwellings shall receive a registered CF3R. If there are fewer than five dwelling units, the group shall be allowed to remain open and eligible to receive additional dwelling units. Dwelling units entered into the open group after the successful CF3R of the tested dwelling shall also receive a registered CF3R as a nontested dwelling subject to receipt of the registered CF2R by the HERS registry for the dwelling. The group shall be closed when it reaches the limit of five dwellings, when the six-month limit for open groups has been exceeded, or when the builder requests that the group be closed.

The HERS Rater must confirm that the CF2Rs have been registered and are consistent with the CF1R for the dwelling unit.

The HERS Rater must perform one or more HERS verification on the selected dwelling unit and enter the results into the HERS registry regardless of whether the results indicate a pass or fail. If the test fails, then the failure must be entered into the registry, even if the installer immediately corrects the problem. In addition, any applicable procedures for resampling, full testing, and corrective action must be followed as described in Section 2.5.5 below.

If HERS verification determines that the requirements for compliance are met, the HERS Rater will enter the test results into the HERS registry. The HERS provider will make available to approved users of the registry a registered copy of the CF3R for the tested requirement and for all other nontested requirements in the group at the time of the sample test. To avoid confusion by placing test results on untested requirements, the registry will not report the results of tested requirements on the corresponding CF3Rs for untested requirements in the sample group. The results will be reported only on the CF3R for the tested requirements within the sample group. However, CF3Rs for untested features will conform to all other registration requirements and specify that the feature was not tested but has passed compliance as part of a sample group. The HERS provider must close any open group within six

months after the earliest signature date shown on any CF2R for a dwelling entered in the group. When such group closure occurs, the provider shall notify the builder that the group has been closed and require that a sample dwelling be selected for HERS verification by a HERS rater if HERS verification has not yet been conducted on a sample dwelling entered in the group.

### **2.5.5 Resampling, Full Testing, and Corrective Action**

When a failure is encountered during sample testing, the failure must be entered into the HERS registry for retention by the HERS Rater. Corrective action must be taken on the failed dwelling unit. The dwelling unit must be retested to verify that corrective action was successful, and the dwelling complies. Corrective action and retesting on the dwelling unit must be repeated (and registered) until the testing determines that the dwelling complies, and the successful compliance results have been entered into the registry. A registered CF3R for the dwelling shall be made available to authorized users of the registry.

In addition, the HERS Rater must resample and test a second randomly selected dwelling within the sample group to assess whether the first failure is unique or if the rest of the dwelling units are likely to have similar failings. “Resampling” is the procedure that requires testing of additional dwellings within a group when the initial selected sample dwelling from a group fails to pass HERS verification.

When resampling in a closed group, if the testing of a second randomly selected dwelling in the group confirms that the requirements for compliance credit are met for that unit, then the unit with the initial failure does not indicate failure in the remaining untested units. A copy of the CF3R will be made available for the remaining dwelling units in the group, including the unit in the resample. If the second sample results in a failure, the HERS Rater must report the second failure to the registry. All the nontested units in the group must be individually HERS-verified.

Additional information is in Reference Residential Appendix RA2.6.

### **2.5.6 Installer Requirements and HERS Procedures for Alterations**

When compliance for an alteration requires HERS verification by a certified HERS Rater, the building owner may choose for the HERS verification to be completed for each dwelling unit or as part of a designated sample group of dwelling units. The building owner may choose the same installing company that completed the work that requires HERS verification for compliance. The dwelling units in a designated sample group are not required to be within the same enforcement agency jurisdiction; however, an enforcement agency may require that a separate dwelling unit from the sample group that is located within its jurisdiction be tested. The only alterations that will require HERS verification are HVAC changeouts. When compliance requires HERS verification, the building owner or its agent must arrange for registration of the CF1R information to the registry, identifying the altered HVAC system and features that require HERS verification. The building owner must also submit a registered copy of the CF1R to the HERS Rater.

When the installation is complete, the person responsible for the performance of the installation must complete the CF2Rs. If the HERS Rater tests the features on behalf of the installer, this test disqualifies the associated dwelling from group sampling, and the dwelling must be removed from the group or else all dwellings in that group must be verified.

After confirming that the CF1R and all required CF2Rs are registered, the HERS Rater must perform the HERS verification for each HERS requirement. The sampling procedures described in Reference Residential Appendix RA2.6.3.3 and RA2.8 for sampling a closed group of up to seven dwellings must be used. It requires that all dwelling units (HVAC systems) within the group have been serviced by the same installing company. The installing company may request a group for sampling that is smaller than seven dwelling units (HVAC systems). Resampling, full testing, and corrective action must be completed, if necessary, as specified by Reference Residential Appendix RA2.6.4.

Whenever the HERS Rater for the group is changed, a new group must be established.

The enforcement agency(ies) cannot approve the alteration until the agency has a registered CF1R, CF2R, and CF3R for the altered HVAC system. The agency will also verify that the installing contractor provides copies of all these forms to the homeowner.

TPQCP, as specified in Reference Residential Appendix RA2.7, may also be used with alterations and must be limited to closed sample group sizes of 30 dwelling units or fewer. When a TPQCP is used, the enforcement agency may approve compliance based on the CF2Rs where data checking has indicated that the unit complies, on the condition that if the required HERS testing procedures determine that resampling, full testing, or corrective action is necessary, such work shall be completed.

### **2.5.7 For More Information**

More details on HERS verification and HERS registries are in the *2022 Reference Residential Appendices and 2022 Reference Joint Appendices*, as described below:

1. Reference Joint Appendix JA7 – Data Registry Requirements
2. Reference Residential Appendix RA2 – Residential HERS Verification, Testing, and Documentation Procedures
3. Reference Residential Appendix RA3 – Residential Field Verification and Diagnostic Test Protocols



**Example 2-9****Question**

Given a multifamily building that has ducted HVAC systems and HERS-verified duct leakage verification for all the dwelling units in the building, what is the correct sampling procedure for HERS field verification and diagnostic testing for the air distribution ducts?

**Answer**

If the builder of a multifamily building chooses to comply using sampling, then the sampling is done using groups composed of dwelling units that have used the same HERS requirements for compliance but also share the same basic floor plan layout and energy design. (These similar features define the model.) Dwellings that do not have the same HERS requirements specified for compliance are not allowed to be placed in the same HERS sample group.

For multifamily buildings, variations in exterior surface areas caused by location of dwelling units within the building do not cause dwelling units to be considered a different model floor plan. When verifying a dwelling unit, all the duct systems associated with every HVAC unit in the dwelling must be tested to determine compliance for that dwelling.

For this example, since duct testing is the only HERS requirement specified for all the dwelling units, all the dwelling units in the building can be grouped together for HERS verification requirements. The procedures for assigning dwellings to groups and the HERS verification of a sample from each group must follow the same procedure as for single-family dwellings described in Section 2.5.2 in this chapter and in Reference Residential Appendix RA2.

The installer will designate a dwelling unit for each model in the building to be verified by the rater before the formation of sample groups.

After verification of the first dwelling of each model floor plan is complete, the rater must randomly select a sample dwelling unit from each group of dwellings that have been formed. These samples must be tested according to applicable procedures in Reference Residential Appendix RA3 and documented according to procedures in Reference Residential Appendix RA2. In a sampled dwelling unit that is to be tested to confirm compliance, the duct system associated with every HVAC unit in that dwelling unit must be tested. However, duct systems do not have to be tested in dwelling units that are not selected for sampling (nontested dwelling), provided the dwelling that was tested complies.

If the tested dwelling in the group complies with the verification, the remaining dwellings in the sample group are certified for compliance based on the results of the sample dwelling test result. Testing must be done on every duct system in a dwelling unit, regardless of whether it appears that the HVAC and duct system are in conditioned space. This is akin to a single-family residence with one HVAC unit serving upstairs with ducts in the attic and another serving downstairs with ducts between floors.

---

## Table of Contents

3	Building Envelope Requirements .....	3-1
3.1	Overview .....	3-1
3.1.1	Navigating This Chapter .....	3-1
3.2	New Envelope Requirements for 2022 .....	3-2
3.3	Fenestration (Window/Skylight/Glazed Door) and Opaque Doors .....	3-2
3.3.1	Fenestration Types .....	3-3
3.3.1.1	Windows and Glazed Doors .....	3-3
3.3.1.2	Opaque Doors .....	3-3
3.3.1.3	Skylights and Tubular Daylight Devices.....	3-3
3.3.1.4	Fenestration Subcategories.....	3-3
3.3.1.5	Fenestration Definitions.....	3-4
3.3.2	Mandatory Requirements §10-111, §10-112, §110.6.....	3-7
3.3.3	U-Factor and SHGC Ratings §110.6(a), Table 110.6-A, Table 110.6-B ..	3-11
3.3.4	Air Leakage §110.6(a)1, §110.7.....	3-15
3.3.5	Prescriptive Requirements §150.1(c)3, §150.1(c)4, §150.1(c)5, and Table 150.1-A.....	3-16
3.3.6	Fenestration in the Performance Approach §150.1(b) .....	3-21
3.4	Opaque Envelope .....	3-27
3.4.1	Opaque Envelope Definitions .....	3-27
3.4.2	Air Sealing and Air Leakage §110.7, §150.0 .....	3-29
3.4.3	Roofing Products §10-113, §110.8(i), §150.1(c)11.....	3-31
3.4.4	Radiant Barriers §110.8(j), §150.1(c)2.....	3-36
3.4.5	Vapor Retarder §150.0(g) and RA4.5.1.....	3-38
3.5	Insulation Products.....	3-40
3.5.1	Types of Insulation Products.....	3-41
3.5.2	Insulation Product Requirements §110.8(a) .....	3-46
3.5.3	Ceiling and Roof Insulation §110.8(d), §150(a) .....	3-47
3.5.4	Wall Insulation .....	3-60
3.5.5	Raised-Floor Insulation §150.0(d) .....	3-65
3.5.6	Slab Insulation .....	3-67

- 3.5.7 Thermal Mass..... 3-71
- 3.5.8 Quality Insulation Installation (QII) RA 3.5 ..... 3-72
- 3.6 Opaque Envelope in the Performance Approach ..... 3-77
  - 3.6.1 Unvented Attics ..... 3-79
  - 3.6.2 Above-Roof Deck Insulation..... 3-80
  - 3.6.3 Insulated Roof Tiles ..... 3-83
  - 3.6.4 Raised Heel, Extension Truss, or Energy Truss ..... 3-85
  - 3.6.5 Nail Base Insulation Panel ..... 3-86
  - 3.6.6 Advanced Wall Systems and Advanced Framing ..... 3-87
  - 3.6.7 Metal Framing ..... 3-93
  - 3.6.8 Structural Foam Wall Systems..... 3-93
  - 3.6.9 RESERVED ..... 3-94
  - 3.6.10 HERS-Verified Reduced Building Air Leakage RA3.8 ..... 3-96
- 3.7 Alternative Construction Assemblies ..... 3-97
  - 3.7.1 Log Homes..... 3-97
  - 3.7.2 Straw Bale ..... 3-98
  - 3.7.3 Structural Insulated Panels (SIPs) ..... 3-99
  - 3.7.4 Insulating Concrete Forms (ICF) .....3-100

## 3 Building Envelope Requirements

---

### 3.1 Overview

This chapter covers building envelope features and compliance strategies and highlights the Energy Code requirements that affect the design of the building envelope for newly constructed single family residential buildings. See Chapter 9 for information on alterations and additions.

The design of envelope components can significantly affect the energy demand needed to meet heating and cooling loads to maintain the desired internal building temperature.

Heating and cooling load calculations are used to determine the mechanical system design needed for space heating and cooling.

- **Heating Loads:** The principal components of heating loads are infiltration and conduction losses through building envelope components, including walls, roofs, floors, slabs, windows, and doors.
  - **Example:** A dwelling unit located in climate zone 16 typically has a large heating load due to moderate summers, cool temperatures, and snow cover that predominates for more than half of the year.
- **Cooling Loads:** Cooling loads are dominated by solar gains through windows, skylights, and roof/attic assemblies.
  - **Example:** A dwelling unit located in climate zone 15 typically has a large cooling load due to extremely hot and dry summers and moderately cold winters.

#### 3.1.1 Navigating This Chapter

This chapter is organized by building envelope component as seen in the Table of Contents.

This chapter includes:

- An overview of changes to building envelope requirements for the 2022 Energy Code
- A description of fenestration terminology, requirements and labeling, U-factor and solar heat gain coefficient (SHGC) requirements, and credits that can be used under the performance approach
- Description of opaque envelope terminology, requirements related to insulation, roof products, radiant barriers, air barriers, vapor retarders, and attic ventilation

- Compliance approaches for alternative construction assemblies such as log homes, straw bale, structural insulated panels (SIPs) and insulated concrete form (ICF) construction

### 3.2 New Envelope Requirements for 2022

The *2022 Building Energy Efficiency Standards* for residential buildings include increased efficiencies for several envelope requirements, and there are improvements that have been made to better aid the designer, builder, and building official.

#### MANDATORY §150.0

- Mandatory roof deck insulation in newly constructed attic systems in Climate Zones 4 and 8-16 to meet an area-weighted average U-factor no greater than 0.184.
- Mandatory minimum U-factor for Fenestration products including skylight decreased to 0.45

### 3.3 Fenestration (Window/Skylight/Glazed Door) and Opaque Doors

Fenestration products such as windows, glazed doors, dynamic glazing, window films, and skylights have a significant impact on energy use and heating and cooling loads in a home. The size, orientation, and types of fenestration products can dramatically affect the overall energy performance of a house. Glazing type, orientation, shading, and shading devices not only play a major role in the energy use of a building, but can affect the operation of the lighting system, HVAC system, and comfort of occupants.

**Table 3-1 Relevant Sections in the Energy Code**

	<b>MANDATORY</b>	<b>PRESCRIPTIVE</b>	<b>PERFORMANCE</b>
Fenestration and Opaque Doors	§10-111, §10-112, §110.6, §150.0(q), Tables 110.6-A and 110.6-B	§150.1(c)3, §150.1(c)4, §150.1(c)5  Table 150.1-A	§150.1(a), §150.1(b)
Limit Air Leakage	§110.7	-	-

Source: California Energy Commission

### 3.3.1 Fenestration Types

#### 3.3.1.1 Windows and Glazed Doors

A window is a vertical fenestration product that is an assembled unit consisting of a frame and sash component holding one or more pieces of glazing. Window performance is measured with the U-factor and solar heat gain coefficient (SHGC).

Glazed doors are an exterior door having a glazed area of 25 percent or more of the area of the door. Glazed doors are treated the same as windows and must meet the U-factor and SHGC requirements for windows. Most sliding glass doors, French doors, and some entry doors with large amounts of glazing will meet the definition to be treated as glazed doors.

#### 3.3.1.2 Opaque Doors

When the door has less than 25 percent glazing material, it is considered an opaque door and is subject to the door U-factor requirements. Doors between the garage and conditioned space that are required to have fire protection are not required to meet the U-factor requirement.

#### 3.3.1.3 Skylights and Tubular Daylight Devices

Skylights and tubular daylight devices (TDD) are an exceptional source of daylight and passive solar heating, illuminating rooms with direct and indirect sunlight. When used appropriately, daylighting can increase the quality of light in a room and reduce dependence upon electrical lighting.

Skylights and TDDs don't typically have the same thermal properties as vertical fenestration and can be prone to greater heat loss in winter and solar heat gain during the summer. When a building designer optimizes the whole envelope glazing arrangement for daylight and thermal control, significant heating and cooling energy savings can be realized, especially when skylights and TDDs are as efficient as other vertical windows used.

Windows are considered part of an exterior wall when the slope is 60° or more as measured from the horizontal. Where the slope of fenestration is less than 60°, the glazing indicated as a window is considered a skylight and part of the roof.

#### 3.3.1.4 Fenestration Subcategories

A. **Manufactured fenestration** is a fenestration product constructed of materials that are factory-cut or otherwise factory-formed with the specific intention of being used to fabricate a fenestration product. Knocked down or partially assembled products may be sold as a fenestration product when provided with temporary and permanent labels, as described in §10-111, or as a site-built fenestration product when not provided with temporary and permanent labels, as described in §10-111.

B. **Site-built fenestration** is designed to be field-glazed or field-assembled units, using specific factory-cut or other factory-formed framing, and glazing units that

are manufactured with the intention of being assembled at the construction site. These include storefront systems, curtain walls or large-track sliding glass walls, and atrium roof systems.

- C. **Field-fabricated fenestration** is when the windows are fabricated at the building site from elements that are not sold together as a fenestration product (that is, separate glazing, framing, and weatherstripping elements). Field-fabricated does not include site-assembled frame components that were manufactured elsewhere with the intention of being assembled on site (such as knocked-down products, sunspace kits, and curtain walls).

### 3.3.1.5 Fenestration Definitions

- A. **Center of glass.** U-factor, solar heat gain coefficient (SHGC), and visible transmittance (VT) are measured only through glass at least 2.5 inches from the edge of the glass or dividers.
- B. **Clear glass** has little, if any, observable tint with an insulated glass (IG) unit with an SHGC of 0.5 or greater.
- C. **Chromogenic** is a class of glazing that can change the optical properties by including active materials (e.g., electrochromic) and passive materials (e.g., photochromic and thermochromic) permanently integrated into the glazing assembly.
- *Electrochromatic* is a class of glazing that tints on demand using a small amount of electricity.
- D. **Divider (muntin).** An element that physically or visually divides different lites of glass. (See Definition K.) It may be a true divided lite, between the panes, or applied to the exterior or interior of the glazing.
- E. **Double-pane window.** Double-pane (or dual-pane) glazing is made of two panes of glass (or other glazing material) separated by space (generally ¼" [6 mm] to ¾" [18 mm]) filled with air or other gas. Two panes of glazing laminated together do not constitute double-pane glazing
- F. **Dynamic glazing.** Glazing systems that have the ability to reversibly change the performance properties, including U-factor, solar heat gain coefficient (SHGC), and/or visible transmittance (VT) between well-defined end points. Includes active materials (e.g., electrochromic) and passive materials (e.g., photochromic and thermochromic) permanently integrated into the glazing assembly.

With appropriate controls, electrochromic glass can be darkened or lightened to adjust the levels of daylight and solar heat gain. These products have the ability to reversibly change the SHGC and VT between well-defined endpoints.

*Integrated shading systems* is a class of fenestration products including an active layer (e.g., shades, louvers, blinds, or other materials) permanently



integrated between two or more glazing layers and that has the ability to reversibly change performance properties, including U-factor, SHGC, and/or VT between well-defined end points.

- G. **Fixed.** The fenestration product cannot be opened.
- H. **Gap width.** The distance between glazing in multi-glazed systems (e.g., double or triple glazing). This dimension is measured from inside surface to inside surface. Some manufacturers may report "overall" IG unit thickness, which is measured from outside surface to outside surface.
- I. **Grille.** See Divider.
- J. **Insulating glass unit (IG unit or IG).** An IG unit includes the glazing, coatings, tinting, spacer(s), films (if any), gas infills, and edge caulking.
- K. **Light or lite.** A layer of glazing material, especially in a multilayered IG unit. Referred to as panes in §110.6 when the lites are separated by a spacer from inside to outside of the fenestration.
- L. **Low emissivity (Low-e) coatings.** Low-e coatings are special coatings applied to the second, third, or fourth surfaces in double-glazed windows or skylights. As the name implies, the surface has a low emittance, meaning that radiation from that surface to the surface it "looks at" is reduced. Since radiation transfer from the hot side to the cool side of the window is a major component of heat transfer in glazing, low-e coatings are very effective in reducing the U-factor. They do nothing, however, to reduce losses through the frame.

Low-e coatings can be engineered to have different levels of solar heat gain. Generally, there are two kinds of low-e coatings:

1. Low-solar-gain low-e coatings are formulated to reduce air-conditioning loads. Fenestration products with low-solar-gain low-e coatings typically have an SHGC of 0.40 or less. Low-solar-gain low-e coatings are sometimes called *spectrally selective coatings* because they filter much of the infrared and ultraviolet portions of the sun's radiation while allowing visible light to pass through.
2. High-solar-gain low-e coatings, by contrast, are formulated to maximize solar gains. Such coatings would be preferable in passive solar applications or where there is little air conditioning.

Another advantage of low-e coatings, especially low-solar-gain low-e coatings, is that when they filter the sun's energy, they generally remove between 80 percent and 85 percent of the ultraviolet light that would otherwise pass through the window and damage fabrics and other interior furnishings. This is a major advantage for homeowners and can be a selling point for builders.

- M. **Mullion.** A frame member that is used to join two windows into one fenestration unit.
- N. **Muntin.** See Dividers.
- O. **Nonmetal frame.** Includes vinyl, wood, fiberglass, and other low-conductance materials. Vinyl is a polyvinyl chloride (PVC) compound used for frame and divider elements with a significantly lower conductivity than metal and a similar conductivity to wood. Fiberglass has similar thermal characteristics. Nonmetal frames may have metal strengthening bars entirely inside the frame extrusions or metal-cladding only on the surface.
- P. **Operable.** The fenestration product can be opened for ventilation.
- Q. **Solar heat gain coefficient (SHGC).** A measure of the relative amount of heat gain from sunlight that passes through a fenestration product. SHGC is a number between zero and one that represents the ratio of solar heat that passes through the fenestration product to the total solar heat that is incident on the outside of the window. A low SHGC number (closer to 0) means that the fenestration product keeps out most solar heat. A higher SHGC number (closer to 1) means that the fenestration product lets in most of the solar heat.
- SHGC or SHGC<sub>t</sub> is the SHGC for the total fenestration product and is the value used for compliance with the Energy Code.
- R. **Spacer or gap space.** A material that separates multiple panes of glass in an IG unit.
- S. **Thermal break frame.** Includes metal frames that are not solid metal from the inside to the outside but are separated in the middle by a material with a significantly lower conductivity.
- T. **Tinted.** Glazing products formulated to have the appearance of color that alters the solar heat gain and visible transmittance. Common colors include gray, bronze, green, and blue. Some coatings can also appear tinted.
- U. **U-factor.** A measure of how much heat can pass through a construction assembly or a fenestration product. The lower the U-factor, the more energy efficient the product is. The units for U-factor are British thermal units (Btu) of heat loss each hour per square foot (ft<sup>2</sup>) of window area per degree Fahrenheit (°F) of temperature difference (Btu/hr-ft<sup>2</sup>-°F). U-factor is the inverse of R-value.
- The U-factor considers the entire product, including losses through the center of glass, at the edge of glass where a metal spacer typically separates the double-glazing panes, losses through the frame, and through the mullions. For metal-framed fenestration products, the frame losses can be significant.
- V. **Visible transmittance (VT)** is the ratio of visible light transmitted through the fenestration. The higher the VT rating, the more light is allowed through a window.

W. **Window films** are composed of a polyester substrate to which a special scratch-resistant coating is applied on one side, with a mounting adhesive layer and protective release liner applied to the other side.

### **3.3.2 Mandatory Requirements §10-111, §10-112, §110.6**

#### **3.3.2.1 Fenestration Products and Labeling §10-111; §110.6(a)5**

The National Fenestration Rating Council (NFRC) is the entity recognized by the California Energy Commission to supervise the rating and labeling of fenestration products. NFRC maintains the Certified Product Directory, containing NFRC certified U-factors, SHGC and VT values for thousands of fenestration products, on its [website](http://www.nfrc.org) at <http://www.nfrc.org>.

Fenestration product performance data used in compliance calculations must be provided through the NFRC rating program and must be labeled by the manufacturer with the rated U-factor, SHGC, and VT in accordance with §10-111 procedures.

Estimating the rate of heat transfer through a fenestration product is complicated by the variety of frame configurations for operable windows, the different combinations of materials used for sashes and frames, and the difference in sizes available in various applications. The NFRC rating system makes the differences uniform, so that an entire fenestration product line is assumed to have only one typical size. The NFRC-rated U-factor may be obtained from the directory of certified fenestration products, directly from a manufacturer's listing in product literature, or from the product label.

U-factor and solar heat gain (SHGC) are factors that affect the energy performance of a window. There is no minimum requirement for visual transmittance (VT) for low-rise residential buildings but is used for informational purposes. Product labels that clearly state these energy performance ratings help consumers compare the energy efficiency of window and glazed door products of different brands and manufacturers.

There are two types of labels that may be used to meet the requirements in the Energy Code: (1) an NFRC-certified product label or a default label. Manufactured products will need to have both an NFRC temporary label listing certified performance values and a permanent label with information that can be used to trace the product certification file and show that the manufacturer has certified the product per one of the testing methods described in Table 3-2. See the Certified Product Labels section for more information. (2) Default U-factors and SHGC are used when the manufacturer has not certified the product through the NFRC and for site-built fenestration. The temporary default label shall meet the requirements per §10-111. See the Default Label section for more information.

**3.3.2.2 Certified Product Labels: Temporary and Permanent**

**1. Temporary Label for NFRC Certified Manufactured Fenestration Products**

The Energy Code requires that manufactured fenestration have both temporary and permanent labels. The temporary label shows the U-factor and SHGC for each rated window unit. The label must also show that the product meets the air infiltration criteria of §110.6(a)1. The temporary label must not be removed before inspection by the enforcement agency.

**Figure 3-2: Sample Temporary NFRC Label**

	<b>World's Best Window Co.</b> Millennium 2000+ Vinyl-Clad Wood Frame Double Glazing • Argon Fill • Low E Product Type: <b>Vertical Slider</b>	
	<b>ENERGY PERFORMANCE RATINGS</b>	
U-Factor (U.S./I-P)	Solar Heat Gain Coefficient	
<b>0.30</b>	<b>0.30</b>	
<b>ADDITIONAL PERFORMANCE RATINGS</b>		
Visible Transmittance	Air Leakage (U.S./I-P)	
<b>0.51</b>	<b>0.2</b>	
<small>Manufacturer stipulates that these ratings conform to applicable NFRC procedures for determining whole product performance. NFRC ratings are determined for a fixed set of environmental conditions and a specific product size. NFRC does not recommend any product and does not warrant the suitability of any product for any specific use. Consult manufacturer's literature for other product performance information. <a href="http://www.nfrc.org">www.nfrc.org</a></small>		

Source: National Fenestration Rating Council

**2. National Fenestration Rating Council (NFRC) Permanent Label**

The permanent label must, at a minimum, identify the certifying organization and have an ID number or code to allow tracking back to the original information on file with the certifying organization, NFRC. The permanent label can be inscribed on the spacer, etched on the glass, engraved on the frame, or otherwise located so as not to affect aesthetics.

**3.3.2.3 Default Label: Temporary**

The manufacturer can choose to use the Energy Code default values from Table 110.6-A for U-factors and Table 110.6-B for SHGC. The product shall meet the air infiltration requirements of §110.6(a)1, U-factor criteria of §110.6(a)2, and SHGC criteria of §110.6(a)3 in the Energy Code. The manufacturer must attach a temporary label meeting the following specific requirements. (Permanent etching labels are not required.)

There is no template for the default temporary label. It must be clearly visible and large enough for the enforcement agency field inspectors to read easily. It must include all information required by the Energy Code. The minimum suggested label size is 4 in. by 4

in., and the label must have the following words at the bottom of the label as noted in Figure 3-3:

*"Product meets the air infiltration requirements of §110.6(a)1, U-factor criteria of §110.6(a)2, SHGC criteria of §110.6(a)3 and VT criteria of §110.6(a)4 of the 2022 California Building Energy Efficiency Standards for Residential and Nonresidential Buildings."*

The manufacturer ensures the U-factor and SHGC default values are large enough to be readable from four feet away. The manufacturer ensures the appropriate boxes are checked and indicated on the default label.

**Figure 3-3: Sample of Default Temporary Label**

2022 California Energy Commission Default Label XYZ Manufacturing Co.		
<b>Key Features:</b>	<input type="checkbox"/> Doors	<input type="checkbox"/> Double-Pane
	<input type="checkbox"/> Skylight	<input type="checkbox"/> Glass Block
<b>Frame Type:</b>	<b>Product Type:</b>	<b>Product Glazing Type:</b>
<input type="checkbox"/> Metal	<input type="checkbox"/> Operable	<input type="checkbox"/> Clear
<input type="checkbox"/> Non-Metal	<input type="checkbox"/> Fixed	<input type="checkbox"/> Tinted
<input type="checkbox"/> Metal, Thermal Break	<input type="checkbox"/> Greenhouse/Garden Window	<input type="checkbox"/> Single-Pane
<input type="checkbox"/> Air space 7/16 in. or greater	-----	To calculate VT see NA6
<input type="checkbox"/> With built-in curb		
<input type="checkbox"/> Meets Thermal-Break Default Criteria		
<b>California Energy Commission Default U-factor =</b>	<b>California Energy Commission Default SHGC =</b>	<b>California Energy Commission Calculated VT =</b>
Products meets the air infiltration requirements of §110.6(a)1, U-factor criteria of §110.6(a)2, SHGC criteria of §110.6(a)3 and VT criteria of §110.6(a)4 of the 2022 Building Energy Efficiency Standards for Residential and Nonresidential Buildings.		

Source: California Energy Commission

**Note for Building Inspectors:** At the field inspection, the field inspector verifies that the fenestration U-factor and SHGC values meet the energy compliance values by checking the label sticker on the product.

If no labels are available on site for verification, the field inspector should not allow any further installation of fenestration until proof of efficiency (label) is produced. In cases when proof is not met, the field inspector should not allow construction until the designer or builder can produce such labels.

**Manufactured Products.** Product must be rated by the National Fenestration Rating Council (NFRC) and be listed in NFRC’s Certified Product Directory. The test procedure for U-factor is NFRC 100, and for SHGC and VT is NFRC 200 and NFRC

202, or ASTM E972 for translucent panels, and NFRC 203 for tubular daylighting devices (TDDs) and for certain types of other skylights.

When fenestration is not rated by the NFRC, the values found in Energy Commission Default Tables 110.6-A and 110.6-B in the Energy Code must be used. For example, a single-pane, operable, metal-framed fenestration product has a default U-factor of 1.28. To get credit for high-performance window features such as low-emissivity (low-e) coatings and thermal break frames, the window manufacturer must have the window tested, labeled, and certified according to NFRC procedures. When the Energy Code default values are used, they must be documented on a temporary default label (Figure 3-3).

- **Site-Built Products.** For special cases in single family construction in which site-built products are installed, the site-built products shall be treated the same as manufactured products. U-factor and SHGC values must come from NFRC ratings or from the default Table 110.6-A and Table 110.6-B of the Energy Code. Alternatively, calculation procedures in Reference Appendices, Nonresidential Appendix NA6 for nonrated site-built fenestration may be used if the area of the site-built fenestration in a dwelling is less than 250 ft<sup>2</sup> or 5 percent of the conditioned floor area, whichever is larger.
- **Field-Fabricated Products.** Field-fabricated fenestration must always use the Energy Commission default U-factors from Table 110.6-A and SHGC values from Table 110.6-B of the Energy Code.

---

### Example 3-1: Labels When Using CEC Default Values

**Question:** When windows are labeled with a default value, are there any special requirements that apply to the label?

**Answer:** All windows must meet the mandatory requirements in §110.6 and §110.7, unless exempted. These criteria apply to fenestration products labeled with default values:

The administrative regulations (§10-111) require that the words “CEC Default U-factor” and “CEC Default SHGC” appear on the temporary label before the U-factor or SHGC (not in a footnote).

The U-factor and SHGC for the specific product must be listed. If multiple values are listed on the label, the manufacturer must identify the appropriate value for the labeled product. Marking the correct value must be done in one of the following ways:

1. Circle the correct U-factor and SHGC (permanent ink).
  2. Black out all values except the correct U-factor and SHGC (permanent ink).
  3. Make a hole punch next to the appropriate values.
-

### 3.3.3 U-Factor and SHGC Ratings §110.6(a), Table 110.6-A, Table 110.6-B

#### 3.3.3.1 Determining U-Factor and SHGC

The Energy Code requires that U-factor and solar heat gain coefficient (SHGC) be calculated using standardized procedures to ensure that the thermal performance or efficiency data for fenestration products is accurate. The data provided by different manufacturers within each fenestration type (i.e., windows, doors, skylights, TDDs) can easily be compared to others within that type and can be verified independently.

Acceptable methods of determining U-factor and SHGC are shown in Table 3-2.

**Table 3-2: Methods for Determining U-Factor and SHGC**

U-Factor/SHGC Determination Method	Manufactured Windows and Doors	Manufactured Skylights	Site-Built Fenestration (Vertical & Skylight)	Field-Fabricated Fenestration	Glass Block
NFRC-100 (U-Factor) NFRC-200 (SHGC)	✓	✓	✓	N/A	N/A
Energy Code Default Table 110.6-A (U-Factor) Table 110.6-B (SHGC)	✓	✓	✓	✓	✓
NFRC's Component Modeling Approach (CMA) <sup>1</sup>	N/A	N/A	N/A	N/A	N/A
NA6 <sup>2</sup>	N/A	N/A	✓	N/A	N/A

1. The NFRC CMA method is limited to nonresidential and is not currently approved for residential use.
2. The Alternative Default U-factors and SHGCs from Reference Appendices, Nonresidential Appendix NA6 may be used only for total site-built vertical fenestration plus skylights up to 250 ft<sup>2</sup> or 5% of the conditioned floor area, whichever is larger. Residential area allowances are defined in NA6.1(b).

Source: California Energy Commission

**Note for Architects/Designers:** When the alternative procedure from NA6 for unrated site-built fenestration is used in a residential application, it may not meet the prescriptive values as required by Table 150.1-A, even if area-weighted averaging is implemented. In this case, it would be necessary to use the performance approach to meet energy compliance.

---

#### Example 3-2: Multiple Window Types in a Project

**Question:** My new home will have a combination of window types, including fixed, operable, wood, metal, and so forth, some of which are field-fabricated. What are the options for showing compliance with the Energy Code?

**Answer:** All windows must meet the mandatory requirements of §110.6 and §110.7 and the mandatory maximum area-weighted average U-factor of 0.45 from §150.0(q), unless exempted. For field-fabricated windows, you must select U-factors and SHGC values from the default tables (Table 110.6-A and Table 110.6-B of the Energy Code). Windows that are not field-fabricated must be labeled with NFRC-certified or default efficiencies. Few fenestration products in the default tables meet the mandatory maximum U-factor of 0.45 on their own.

If the area-weighted average U-factors or SHGC values do not comply with the prescriptive requirements, the performance method must be used. To simplify data entry into the compliance software, you may choose the U-factor from Table 110.6-A of the Energy Code that is the highest of any of the windows planned to be installed and use this for all windows for compliance. However, you must use the appropriate SHGC from Table 110.6-B for each window type being installed.

---

---

### **Example 3-3: Glass Block**

**Question 1:** Which U-factor is used for an operable metal-framed glass block?

**Answer 1:** For glass block, use the U-factor from Table 110.6-A of the Energy Code for the frame type in which the glass blocks are installed and for the fenestration product type. The U-factor for operable metal-framed glass block from Table 110.6-A is 0.87.

**Question 2:** Which SHGC is used for clear glass block, and can it be used for tinted glass block?

**Answer 2:** Use the default SHGC values from Table 110.6-B, depending upon whether the glass block has a metal or nonmetal frame and whether it is operable or fixed. The default SHGC table does not include tinted glass block, so use the clear glass block SHGC as the default for both clear and tinted glass block.

**Question 3:** Does it need a label?

**Answer 3:** Glass block is considered a field-fabricated product and may be installed only if compliance is demonstrated on the compliance documents.

---

---

### **Example 3-4: Sunrooms**

**Question:** Is there a default U-factor for the glass in sunrooms?



**Answer:** If the sunroom is part of the conditioned floor area, then yes. For the horizontal or sloped portions of the sunroom glazing, use the U-factor for skylights. For the vertical portions, use the U-factors for fixed windows, operable windows, or doors, as appropriate. As a simple alternative, the manufacturer may label the entire sunroom with the highest U-factor of any of the fenestration types within the assembly.

---

---

### Example 3-5: Glazed Doors

**Question 1:** How are exterior glazed doors treated in compliance documentation for U-factor and SHGC?

**Answer 1:** All doors with glass area greater than or equal to 25 percent of the door area, which includes French doors, are defined as fenestration products and are covered by the NFRC Rating and Certification Program. The U-factor and SHGC for doors with 25 percent or more glass area may be determined in one of two ways:

1. Use the NFRC rated and labeled values.
2. Refer to Table 110.6-A and 110.6-B of the Energy Code. The values are based upon glazing and framing type.

In special cases where site-built fenestration is being installed in a residential application, the site-built windows and glazed doors can use an alternative method to calculate the U-factor and the SHGC by using the manufacturer's center-of-glass values (COG). The COG values are calculated in accordance with Reference Appendices, Nonresidential Appendix NA6. To use this calculation, the maximum allowed site-built fenestration is 250 ft<sup>2</sup> or 5% of the conditioned floor area, whichever is larger.

**Question 2:** How can I determine a U-factor and SHGC for doors when less than 25 percent of the door area is glass?

**Answer 2:** Doors with less than 25 percent glass area are treated as opaque exterior doors. For prescriptive or performance approaches, only the U-factor is used for this product type. Use one of the following options for U-factor of the door:

1. The NFRC label if one is available
  2. The default values from Table JA4.5.1 of the Reference Appendices
- 

---

### Example 3-6: Tubular Daylighting Device with Single-Pane Diffuser

**Question:** A tubular daylighting device (TDD) will be used to get daylight into a house. The skylight has a clear plastic dome exterior to the roof, a single-pane ¼-inch (6 mm)-thick acrylic diffuser mounted at the ceiling, and a metal tube connecting the two. How are U-factor and SHGC determined for the performance approach to comply with the Energy Code, if  $U_c$  is 1.20 and  $SHGC_c$  is 0.85?

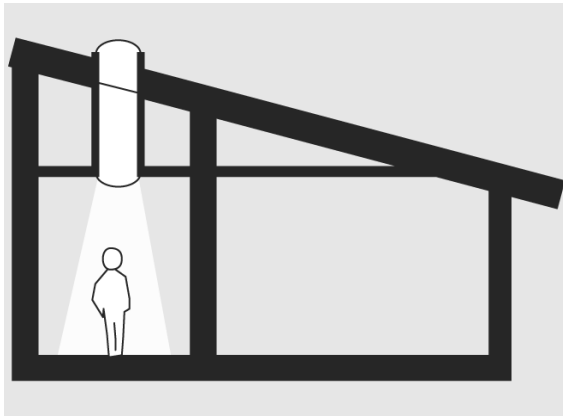

**Answer:** There are three methods available for determining the U-factor for tubular daylighting devices (TDD):

1. Use the NFRC label if the product has been tested and certified under NFRC procedures. This requires a label that states: "Manufacturer stipulates that this rating was determined in accordance with applicable NFRC procedures NFRC 100," followed by the U-factor.
2. Use the default U-factor from Table 110.6-A of the Energy Code. This tubular product would be considered a metal frame, fixed, single-pane skylight resulting in a U-factor of 1.19, which must appear on a label preceded by the words "CEC Default U-factor." (A tubular daylighting device would have to have two panes of glazing with an air space of less than 2 inches [50 mm] between them at the plane of the ceiling insulation for it to be considered double-pane.)
3. Determine the U-factor from Reference Appendices, Nonresidential Appendix NA6, Equation NA6-1. The U-factor for this tubular daylighting device would be based on metal with no curb (Table NA6-5). The U-factor for this skylight, using Equation NA6-1, is 1.25, where  $U_t = (0.195 + (0.882 \times 1.20))$ . This must appear on a label stated as "CEC Default U-factor 1.25."

There also are three methods available for determining SHGC for tubular daylighting devices (TDD):

1. Use the NFRC label if the skylight has been tested and certified under NFRC procedures and requires a label that states: "Manufacturer stipulates that this rating was determined in accordance with applicable NFRC procedures."
2. Use the default table SHGC in Table 110.6-B of the Energy Code. This tubular daylight device would be considered a metal-frame, fixed, clear, single-pane skylight resulting in an SHGC of 0.83, which must appear on a label stated as "CEC Default SHGC 0.83."
3. Determine the SHGC from Reference Appendices, Nonresidential Appendix NA6, Equation NA6-2. The SHGC for this skylight using Equation NA6-2 is 0.81, where  $SHGC_t = (0.08 + (0.86 \times 0.85))$ . This must appear on a label stated as "CEC Default SHGC 0.81."

---

### **Example 3-7: Tubular Daylighting Device with Dual-Pane Diffuser**

**Question:** How are the U-factor and the SHGC determined if the tubular daylighting device (TDD) in the previous example has a dual-pane diffuser (instead of single-pane) mounted at the ceiling?

**Answer:** The procedure would be the same as Example 3-6, except that the double-pane U-factor and SHGC values from Tables 110.6-A and 110.6-B of the Energy Code would be used instead of single-pane values. Up to 3 ft<sup>2</sup> of tubular daylighting device with a dual-pane diffuser is assumed to have the prescriptive U-factor and SHGC from Table 150.1-A for compliance calculations (Exception 1 to §150.1[c]3A).

---

### 3.3.4 Air Leakage §110.6(a)1, §110.7

- Air leakage is a measurement of heat loss and gain by infiltration and exfiltration through cracks in the window assembly, which can affect occupant comfort. The lower the air leakage, the lower the amount of air that will pass through cracks in the window assembly.
  - A. **Manufactured Products.** Must be tested and certified to leak no more than 0.3 cubic feet per minute (cfm) per ft<sup>2</sup> of the window area. This mandatory requirement applies to all manufactured windows that are installed in newly constructed residential (including high-rise) buildings or newly installed in existing buildings. To determine air leakage, the standard test procedure requires manufacturers to use either NFRC 400 or ASTM E283 at a pressure differential of 75 Pascal (or 1.57 pounds/ft<sup>2</sup>).
  - B. **Site-Built Products.** There are no specific air leakage requirements for site-built fenestration products, but the Energy Code requires limiting air leakage by weatherstripping and caulking.
  - C. **Field-Fabricated Products.** No air leakage testing is required for field-fabricated fenestration products; however, the Energy Code still requires limiting air leakage by weatherstripping and caulking.
  - D. **Exterior Doors.** Exterior doors, which includes pet doors, must meet the following requirements:
    1. Manufactured exterior doors must be certified as meeting an air leakage rate of 0.3 cfm/ft<sup>2</sup> of door area at a pressure differential of 75 Pascal, which is the same as windows.
    2. Field-fabricated exterior doors must comply with the requirements of §110.6, as described by "Other Openings." For example, these must be caulked and weather stripped.
    3. Any door with a surface area greater than or equal to 25 percent glass is considered a glazed door and must comply with the mandatory and applicable prescriptive and performance requirements of §150.0, §150.1, and §150.2.

4. For any door with a surface area less than 25 percent glass, the area may be exempt in accordance with one of the exceptions of §150.0, §150.1, and §150.2.

---

**Example 3-8: Which Fenestration Products Must Be Tested and Certified for Air Leakage?**

**Question:** As a manufacturer of fenestration products, I place a temporary label with the air infiltration rates on my products. Can you clarify which products must be tested and certified?

**Answer:** Each product line must be tested and certified for air infiltration rates. Features such as weather seal, frame design, operator type, and direction of operation affect air leakage. Every product must have a temporary label certifying that the air infiltration requirements are met. This temporary label may be combined with the temporary U-factor, SHGC, and VT label.

---

---

**Example 3-9: Infiltration Requirements for Custom Windows**

**Question:** Is a custom window “field-fabricated” for meeting air infiltration requirements?

**Answer:** No. Most custom windows are manufactured and delivered to the site either completely assembled or “knocked down,” which means they are a manufactured product. A window is considered field-fabricated when the windows are assembled at the building site from the various elements that are not sold together as a fenestration product (such as glazing, framing, and weatherstripping). Field-fabricated does not include site-assembled frame components that were manufactured elsewhere with the intention of being assembled on site (such as knocked-down products, sunspace kits, and curtain walls).

---

---

**Example 3-10: Pet Doors to the Exterior**

**Question:** How is a pet door installed in an exterior wall accounted for in a newly constructed residential building design?

**Answer:** Pet doors must meet all exterior door requirements. U-factor must be determined by an NFRC accredited testing lab using NFRC 100 U-factor requirements; otherwise, nonrated pet doors will assume no more than the maximum U-factor of 0.99 based on a nonmetal single-pane door U-factor. (See Table 110.6-A of the Energy Code.) The rated pet door shall not exceed 0.3 cfm/ft<sup>2</sup> air leakage when tested using ASTM E283. The performance compliance approach must be used when a pet door is installed.

---

**3.3.5 Prescriptive Requirements §150.1(c)3, §150.1(c)4, §150.1(c)5, and Table 150.1-A**

**Fenestration**

Prescriptive requirements described in this chapter typically refer to Table 150.1-A. The maximum fenestration U-factor required prescriptively for all climate zones is 0.30, and the maximum SHGC is 0.23 for residences in climate zones 2, 4, and 6 through 15. Homes constructed in climate zones 1, 3, 5, and 16 have no SHGC requirements.

The requirements apply to fenestration products without consideration of insect screens or interior shading devices. With some exceptions, some fenestration products may exceed the prescriptive requirement as long as the U-factor and SHGC of windows, glazed doors, and skylights can be area weight-averaged together to meet the prescriptive requirement using the CF1R-ENV-02-E compliance document in Appendix A of this manual.

**Opaque Doors**

An *opaque door* is an installed swinging door separating conditioned space from outside or adjacent unconditioned space with less than 25 percent glazed area. A door that has 25 percent or more glazed area is considered a glazed door and is treated like a fenestration product (Section 3.5.8).

Opaque doors are prescriptively required to have an area-weighted average U-factor no greater than U-0.20, per Table 150.1-A. Swinging doors between the garage and conditioned space that are required to have fire protection are exempt from the prescriptive requirement. The U-factor must be rated in accordance with NFRC 100, or the applicable default U-factor defined in Reference Appendices, Joint Appendix Table JA4.5.1 must be used.

**Note for Building Inspectors:** At the field inspection, the field inspector verifies that the door U-factor meets the energy compliance values by checking the NFRC label sticker on the product. When manufacturers do not rate the thermal efficiencies by NFRC procedures, the Energy Commission default values must be used and documented on a temporary default label (Figure 3-3).

**Table 3-3: Maximum U-Factors, SHGC, and Fenestration Area by Climate Zone in the Prescriptive Package**

Climate Zone	1, 3, 5, 16	2,4,6-15
Maximum Fenestration U-Factor	0.30	0.30
Maximum Fenestration SHGC	NR	0.23
Maximum Fenestration Area	20%	20%
Maximum West-Facing Fenestration Area	NR	5%
Maximum Opaque Door U-Factor	0.20	0.20

Source: California Energy Commission

**Figure 3-3-4: Prescriptive Package, SHGC, and West-Facing Area Criteria by Climate Zone**

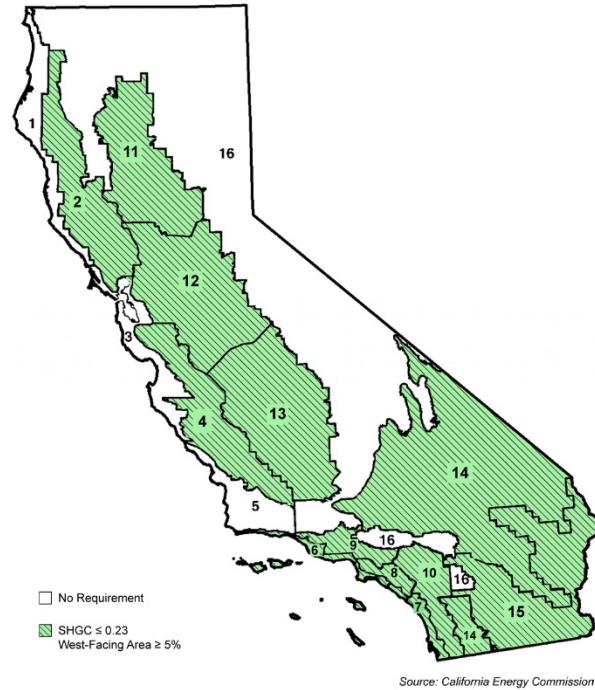

Source: California Energy Commission

### 3.3.5.1 Fenestration and Opaque Door Prescriptive and Mandatory Exceptions

#### A. Glazed Doors

Any door that is more than 25 percent or greater glass is considered a glazed door and must comply with the mandatory requirements and other requirements applicable to a fenestration product. Up to 3 ft<sup>2</sup> of glass in a door is exempt from the U-factor and SHGC requirements (or can be considered equivalent to the prescriptive package values). The U-factor and SHGC shall be based on either the NFRC values for the entire door, including glass area, or use default values in Table 110.6-A for the U-factor and Table 110.6-B for the SHGC. If the door has less than 25 percent glazing, the glazing portion of the door is ignored in the prescriptive approach.

#### B. Tubular Daylighting Device (TDD)

In each dwelling unit, up to 3 ft<sup>2</sup> of tubular daylighting devices area with dual-pane diffusers at the ceiling are exempt from the prescriptive U-factor and SHGC requirements, where the TDD area is included in the maximum of 20 percent fenestration area. However, the U-factor shall not exceed a maximum of 0.45. See §150.0(q) and Exception 1 of §150.1(c)3A.

#### C. Opaque Doors

- Opaque doors between the garage and conditioned space that are required to have fire protection are not required to meet the prescriptive U-factor requirement of 0.20. See Exception to §150.1(c)5.

#### D. Skylights

- Each new dwelling unit may have up to 16 ft<sup>2</sup> of skylight area. The total area of skylights is included in the maximum of 20 percent fenestration area and must meet a maximum 0.55 U-factor and a maximum SHGC of 0.30. See Exception 2 of §150.1(c)3A.

Aside from the specific exceptions to the fenestration prescriptive requirements, the area weight-averaged U-factor and SHGC must not exceed the 0.55 U-factor and cannot be greater than the 0.30 SHGC when large numbers of skylights are used for prescriptive compliance. Alternatively, the performance approach may be used to meet energy compliance.

#### E. Dynamic Glazing

If a dwelling unit includes a type of dynamic glazing that is electrochromatic, chromogenic, or an integrated shading device and the glazing is automatically controlled, use the lowest U-factor and lowest SHGC to determine compliance with prescriptive package fenestration requirements. Since this type of product has compliance ratings that vary, it cannot be weight averaged with nonchromogenic products as per Exception 3 of §150.1(c)3A.

#### F. Site-Built Fenestration

When a dwelling unit contains a combination of manufactured and site-built fenestration, only the site-built fenestration values can be determined by using Reference Appendices, Nonresidential Appendix NA6. All fenestration, including site-built, can default to Table 110.6-A and Table 110.6-B.

#### G. Maximum Area

The prescriptive requirements limit total glass area to a maximum of 20 percent of the conditioned floor area in all climate zones.

- **Note:** There are exceptions to the prescriptive requirements for alterations in §150.2(b)1A that allow additional glass area beyond the 20 percent limitation, including west-facing glass. See Chapter 9 for more information on alterations.
- #### H. Greenhouse Windows/Garden Windows

- Compared to other fenestration products, the NFRC-rated U-factor for greenhouse windows are comparatively high. Section 150.0(q) includes an exception from the U-factor requirement for dual-glazed greenhouse or garden windows that total up to 30 ft<sup>2</sup> of fenestration area.

### 3.3.5.2 Prescriptive Credit for Exterior Shading Devices §150.1(c)4

The prescriptive requirements require fenestration products with a SHGC of 0.23 or lower in climate zones 2, 4, and 6 through 15. However, a fenestration product with an SHGC greater than 0.23 may be used with the prescriptive requirements if a

qualifying exterior shading device is used and the combined area-weighted average complies with the prescriptive requirements. Exterior shading devices and associated SHGC values are shown in Table 3-4. These include woven sunscreens as well as perforated metal sunscreens. As shown in the table, these devices transmit between 13 percent and 30 percent of the sun that strikes them.

**Table 3-4: Exterior Shades and Solar Heat Gain Coefficients**

Exterior Shading Device	SHGC*
Standard Bug (insect) Screen (default for windows)	0.76
Exterior Sunscreens with Weave 53 x 16/inch	0.30
Louvered Sunscreens w/Louvers as Wide as Window Openings	0.27
Low-Sun-Angle Louvered Sunscreen	0.13
Vertical Roller Shades or Retractable/Drop Arm/Combination/Marquisolette and Operable Awnings	0.13
Roll Down Blinds or Slats	0.13
None (for skylights only)	1.00

\* Reference glass values assume single-pane clear glass and metal framing 1/8-inch double-strength (DSS) glass. Use CF1R-ENV-03 worksheet for calculation.

Source: California Energy Commission

When exterior overhangs are used, the SHGC requirements of the prescriptive package may be met if the calculated combination of the overhang and fenestration SHGC efficiency is equal or lower than 0.23.

For credit, exterior shading devices must be permanently attached as opposed to being attached using clips, hooks, latches, snaps, or ties. Exterior shading devices on windows or skylights that are prohibited by life-safety codes from being permanently attached for emergency egress reasons are exempt from this requirement.

**Notes for Plans Examiners:** Compliance document CF1R-ENV-03 is used to calculate the combined SHGC of windows and exterior shading devices. When exterior shades are required for compliance, they must be listed on the CF1R and be documented on the plans.

The SHGC of the window in combination with an exterior device is given by the following:

$$\text{Equation 3-1: } SHGC_{\text{combined}} = (0.2875 \times SHGC_{\text{max}} + 0.75) \times SHGC_{\text{min}}$$

All operable windows and skylights are assumed to have an insect screen as the default condition against which other window and exterior shading device combinations are compared. The standard case is a window with an SHGC of 0.23



and an insect screen with an SHGC of 0.76. For this default case, the SHGC of the window is the  $SHGC_{min}$ , and the SHGC of the exterior sunscreen is  $SHGC_{max}$ . Working through the math on the CF1R-ENV-03 form,  $SHGC_{combined}$  is 0.23. This means that any combination of window SHGC and exterior SHGC that results in a  $SHGC_{combined}$  of 0.23 or less complies with the prescriptive requirements.

Most of the shading devices (other than the default insect screen) have an SHGC of 0.30 or lower. Combining this with the SHGC of any window may result in a combined SHGC that is equal to or lower than the prescriptive criterion of 0.23. This method of combining the SHGC of the window with the SHGC of the exterior shading device can also be used in the whole-building performance approach.

### 3.3.6 Fenestration in the Performance Approach §150.1(b)

While the prescriptive requirements and mandatory requirements establish a minimum level of building energy performance, opportunities to exceed the requirements of the Energy Code are considerable. More information is included in the Performance Compliance section (Chapter 8).

**Note for Architects/Designers:** Options that are recognized for credit through the performance method are called *compliance options*. Most require using the performance approach, but a few exterior shading devices and south-facing overhangs may be used to comply when using the prescriptive approach.

#### 3.3.6.1 Fenestration Area and Orientation

The performance approach includes consideration of the fenestration area and orientation, which can have a big effect on energy use. Compliance is determined by comparing the proposed fenestration to the standard design fenestration.

For buildings with glazing areas less than or equal to 20 percent of the conditioned floor area (CFA), the standard design fenestration for a newly constructed building is modeled with the same glazing area as the proposed home with one-quarter of the window area on the north, east, south, and west orientations. For buildings with more than 20 percent of the CFA, the standard design is limited to 20 percent glass area.

Because of the effects of orientation and the fenestration product performance levels and other building features like overhangs, judging the particular area, orientation, and performance level is a compliance credit or penalty and can be difficult to determine without performance approach calculations.

#### 3.3.6.2 Improved Fenestration Performance

The fenestration weighted average U-factor in the standard design for newly constructed buildings is 0.30 in all climate zones. Choosing high-performance fenestration that performs better than the prescriptive requirements level can earn significant credit through the performance method. For example, in warmer climates (e.g., climate zones 8-15), choosing a window with an SHGC lower than 0.23 will

reduce the cooling loads compared to the standard design. In colder climates (e.g., climates zones 1, 3, 5 and 16) where there are no prescriptive SHGC requirements, choosing a window with an SHGC of 0.35 or lower will inadvertently increase the heating loads compared to the standard design.

The magnitude of the effect will vary by climate zone. In mild coastal climates, the benefit from reducing fenestration U-factor will be smaller than in cold, mountain climates. Several factors affect window performance. For fenestration with NFRC ratings, the following performance features are accounted for in the U-factor and SHGC ratings:

1. Frame materials, design, and configuration (including cross-sectional characteristics). Fenestration can be framed in many materials. The most common include wood, aluminum, vinyl, fiberglass, or composites of these materials. Frames made of low-conductance materials like wood, vinyl, and fiberglass are better insulators than metal. Some aluminum-framed units have thermal breaks that reduce the conductive heat transfer through the framing element compared with similar units having no such conductive thermal break.
2. Number of panes of glazing, low-emissivity coatings, tints, fill gases, cavity dimensions, and spacer construction. Windows compliant with the prescriptive requirements are likely to have at least double-glazing with a low-emissivity coating and argon gas fill with an improved spacer. The choice of low-emissivity coating is particularly important as cooling climates will generally benefit from a low SHGC coating, while heating climates may benefit from a high SHGC coating. There are many ways to improve performance beyond the prescriptive levels. Adding glazing layers such as triple glazing and low-emissivity coatings such as those facing the conditioned space are two likely improvements.
3. Dynamic glazing with appropriate controls may also offer opportunities for improving performance.

### **3.3.6.3 Fixed Permanent Shading Devices**

Shading of windows is also an important compliance option. Overhangs or sidefins that are attached to the building or shading from the building itself are compliance options for which credit is offered through the performance approach. However, no credit is offered for shading from trees, adjacent buildings, or terrain.

The ideal overhang is one that provides shade during the months when the building is likely to be in cooling mode and allows direct solar gains in the heating months. During the summer, the sun is high as it passes over the south side, while in the winter it is low, enabling solar radiation to pass beneath the overhang. Windows that face south can be effectively shaded by overhangs positioned above the window. Due to the potential effectiveness of south-facing overhangs, a prescriptive compliance option is offered. See Section 3.3.5.2 for details.

Shading is more challenging on the east and west sides of the house. When the sun strikes these façades, it is low in the sky, making overhangs ineffective. Vertical fins can be effective, but they degrade the quality of the view from the window and limit the natural light that can enter. In cooling-dominated climates, the best approach is to minimize windows that face east and west. Landscaping features can be considered to increase comfort and energy performance of the building but cannot be used for compliance credit.

#### 3.3.6.4 Interior Shading Devices

There is no credit for interior aftermarket shading devices, although they can be effective in reducing solar gains and should be considered by homeowners. These added interior shades are in the category of home furnishings and not a feature of the house that is provided by the builder or fenestration manufacturer. Draperies, interior blinds, interior shades, and other interior devices are not credited toward energy compliance. A default standard bug screen is still considered in performance calculations, so that estimates of energy use are more realistic and tradeoffs against other requirements are more equitable.

#### 3.3.6.5 Dynamic Glazing

Dynamic glazing products are either integrated shading systems or electrochromatic devices and are considered a fenestration product.

**Figure 3-5: Diagram of Integrated Shading System**

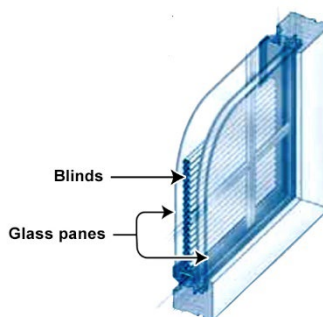

Source: NFRC Dynamic Glazing Products Fact Sheet

**Integrated Shading Systems.** These systems include blinds positioned between glass panes that can be opened and closed using automatic controls, See Figure 3-5.

The labels for integrated shading systems will reflect the endpoints of the product performance for U-factor and SHGC (Figure 3-6). The unique rating “variable arrow” identifier helps consumers understand the “dynamics” of the product and allows comparison with other similar dynamic fenestration products.

If the fenestration product can operate at intermediate states, a dual directional arrow ( $\leftrightarrow$ ) with the word “Variable” will appear on the label. Some dynamic glazing can adjust to intermediate states, allowing for a performance level between the endpoints.

**Figure 3-6: Example of Integrated Shading System NFRC Label**

		<b>World's Best Window Co.</b> Millennium 2000+ Vinyl-Clad Wood Frame Double Glazing • Dynamic Glazing • Argon Fill • Low E Product Type: <b>Vertical Slider</b>	
<b>ENERGY PERFORMANCE RATINGS</b>			
U-Factor (U.S./I-P) <b>0.30</b> ↔ <b>0.40</b> <small>Off/Closed      On/Open</small>		Solar Heat Gain Coefficient <b>0.10</b> ↔ <b>0.50</b> <small>Off/Closed      On/Open</small>	
<b>ADDITIONAL PERFORMANCE RATINGS</b>			
Visible Transmittance <b>0.03</b> ↔ <b>0.65</b> <small>Off/Closed      On/Open</small>		Air Leakage (U.S./I-P) <b>0.2</b>	
<small>Manufacturer stipulates that these ratings conform to applicable NFRC procedures for determining whole product performance. NFRC ratings are determined for a fixed set of environmental conditions and a specific product size. NFRC does not recommend any product and does not warrant the suitability of any product for any specific use. Consult manufacturer's literature for other product performance information. <a href="http://www.nfrc.org">www.nfrc.org</a></small>			

In Figure 3-6, the low value rating is displayed to the left (in the closed or darker position), and the high value rating is displayed to the right (in the open or lighter position). This lets the consumer know at a glance the best and worst case performance of the product and the default performance level. To use the high-performance values for integrated shading systems, the product must have an NFRC Certified Label sticker. Otherwise, the default values from Tables 110.6-A and 110.6-B must be used.

**Figure 3-7: Chromatic Glazing**



Source: NFRC Dynamic Glazing Products Fact Sheet

- Chromatic Glazing.** One type of dynamic glazing product uses a chromatic type of glass that can change the performance properties, allowing occupants to control their environment manually or automatically by tinting or darkening a glass with the flip of a switch. Some fenestration products can change performance automatically with the use of an automatic control or environmental signals. These high-performance windows can reduce energy costs due to controlled daylighting and unwanted heat gain or heat loss.

A view of chromatic glazing in the open (off) and closed (on) position is shown in Figure 3-7. Best-rated performance values may be used for compliance with an NFRC Certified Label sticker and when automatic controls are installed.

- If the window includes either an NFRC label or automatic controls, but not both, then default to Table 150.1-A maximum U-factor of 0.30 and maximum SHGC of 0.23.

Source: Sage  
Electrochromics

- If neither an NFRC label nor automatic controls are included, then the default values from Tables 110.6-A and 110.6-B of the Energy Code must be used.

### 3.3.6.6 Window Films §150.1(b)

Window films are polyester films that offer high clarity and can be pretreated to accept different types of coatings. There are three basic categories of window films:

- **Clear** (nonreflective) films are used as security film to reduce ultraviolet (UV) light, which contributes greatly to fading. They are not commonly used for solar control or energy savings.
- **Tinted or dyed** (nonreflective) films reduce both heat and light transmission, mostly through increased absorbance, and can be used in applications where the desired primary benefit is glare control, with energy savings being secondary.
- **Metalized** (reflective) film can be metalized through vacuum coating, sputtering, or reactive deposition and may be clear or colored. Metalized films are preferred for energy savings applications because they reduce transmission primarily through reflectance and are manufactured to reflect heat more than visible light through various combinations of metals.

To receive window film compliance credit, the following must be met:

- The performance approach must be used to meet energy compliance.
- NFRC Window Film Energy Performance Label (Figure 3-8) is required for each different film applied. If there is no NFRC label, the default values from Tables 110.6-A and Table 110.6-B of the Energy Code must be used.
- Window films must have at least a 15-year manufacturer warranty.

Figure 3-8 shows an example of a NFRC Attachment Ratings Label, which helps identify the energy performance of window films.

**Figure 3-8: Window Film Energy Performance Label**

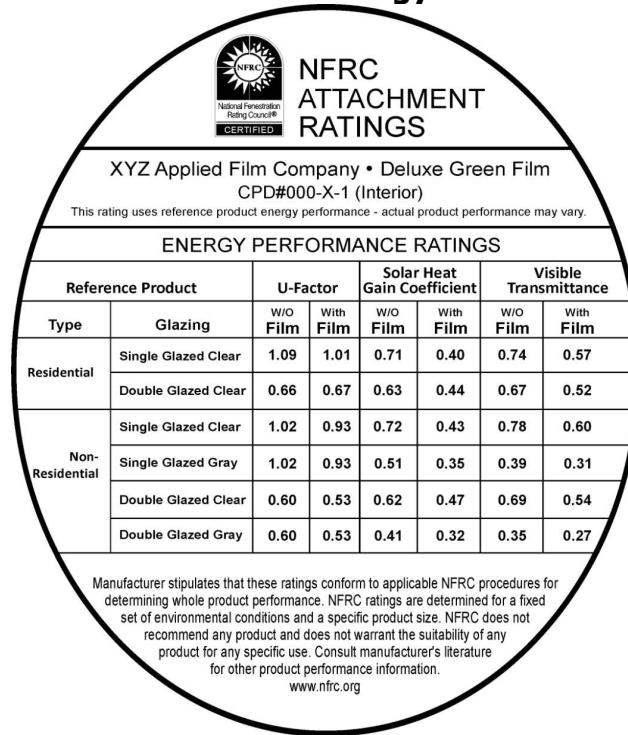

Source: NFRF Applied Film Products Fact Sheet

**3.3.6.7 Bay Windows §150.1(b)**

Bay windows are a special compliance case. Bay windows may have a unit NFRF rating (that is, the rating covers both the window and all opaque areas of the bay window), an NFRF rating for the window only, or no NFRF rating. Nonrated bay windows may or may not have factory-installed insulation.

**A. NFRF Rated**

For bay windows that come with an NFRF rating for the entire unit, compliance is determined based on the rough opening area of the entire unit, applying the NFRF U-factor and SHGC. If the unit U-factor and SHGC do not meet the package requirements or area-weighted average, the project must show compliance using the performance approach.

**B. Nonrated**

Bay windows with no rating for the entire unit (where there are multiple windows that make up the bay) and with factory-installed or field-installed insulation must comply accounting for the performance characteristics of each component separately.

- Opaque portions of bay windows including roofs and floors must be insulated to meet the wall insulation requirements for prescriptive compliance. The opaque portion must either meet the minimum insulation requirements of the prescriptive package for the applicable climate zone or be included in a weighted average U-factor calculation

of an overall opaque assembly that does meet the prescriptive requirements.

- For the windows, the U-factor and SHGC values may be determined either from an NFRC rating or by using default values in Tables 110.6-A and 110.6-B of the Energy Code. If the window U-factor and SHGC meet the package requirements, the bay window complies prescriptively (if overall building fenestration area meets prescriptive compliance requirements).
- If the bay window does not meet prescriptive requirements, the project must show compliance using the performance approach.

### 3.4 Opaque Envelope

This section of the building envelope chapter addresses the requirements for air leakage, roof products, radiant barriers, and vapor retarders in the building envelope. Fenestration, windows, glazed doors, and opaque doors are addressed in Section 3.3. Insulation is addressed in Section 3.5.

**Table 3-5: Relevant Sections in the Energy Code**

<b>Newly Constructed and Additions ≥ 1,000 ft<sup>2</sup></b>	<b>MANDATORY</b>	<b>PRESCRIPTIVE</b>	<b>PERFORMANCE</b>
Air Leakage	§110.7	-	-
Roofing and Radiant Barriers	§10-113, §110.8(i) - §110.8(j)	§150.1(c)2, §150.1(c)11 Table 150.1-A	§150.1(a), §150.1(b)
Vapor Retarders	§150.0(g)	-	-

Source: California Energy Commission

#### 3.4.1 Opaque Envelope Definitions

- Opaque elements of the building envelope significantly contribute to the related energy efficiency. Components of the building envelope include walls, floors, soffits, roofs, and ceilings. Envelope and other building components definitions are listed in §100.1(b) of the Energy Code and the Reference Appendices, Joint Appendix JA1.
  - The exterior partition** is an opaque, translucent, or transparent solid barrier that separates conditioned space from ambient air or unconditioned space.
  - The demising partition** is a wall, fenestration, floor, or ceiling that separates conditioned space from enclosed unconditioned space.

- C. **The conditioned space** is an enclosed space within a building that is either directly conditioned or indirectly conditioned.
- D. **Unconditioned space** is enclosed space within a building that is neither directly conditioned nor indirectly conditioned.
- E. **Plenum** is an air compartment or chamber, including uninhabited crawl space, areas above a ceiling or below a floor, or attic spaces, to which one or more ducts are connected and that forms part of either the supply-air, return-air, or exhaust air system, other than the occupied space being conditioned.
- F. **Attic** is an enclosed space directly below the roof deck and above the ceiling.
- G. **Sloping surfaces** are considered either a wall or a roof, depending on the slope. (See Figure 3-9.) If the surface has a slope of less than 60° from horizontal, it is considered a roof; a slope of 60° or more is a wall. This definition extends to fenestration products, including windows in walls and any skylight types in roofs.

**Figure 3-9: Slope of a Wall or Window (Roof or Skylight Slope Is Less Than 60°)**

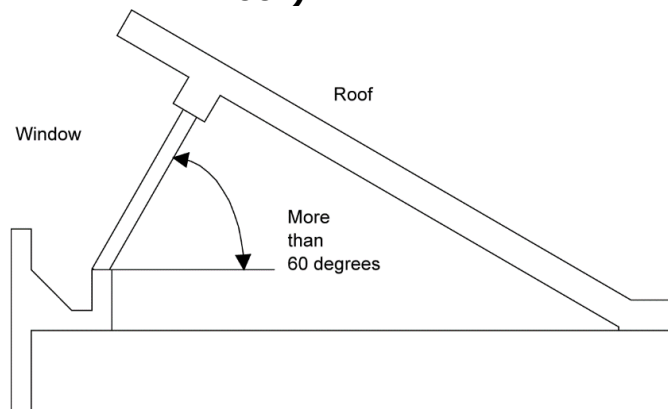

Source: California Energy Commission

- H. **The exterior roof** is an exterior partition that has a slope less than 60 degrees from horizontal, that has conditioned space below, and that is not an exterior door or skylight.
- I. **The roof deck** is the surface that supports the roofing material. Typically made of plywood or OSB, it is supported by the roof framing members such as rafters or trusses.
- J. **Exterior floor/soffit** is a horizontal exterior partition, or a horizontal demising partition, under conditioned space.
- K. **Vapor retarder** or vapor barrier is a material or assembly designed to limit the amount of vapor moisture that passes through that material or assembly.



- L. **Roofing products** are the top layer of the roof that is exposed to the outside, which has properties including, but not limited to, solar reflectance, thermal emittance, and mass.
- M. **Cool roof** is a roofing material with high thermal emittance and high solar reflectance, or low thermal emittance and exceptionally high solar reflectance, as specified in Part 6, that reduces heat gain through the roof.
- N. **Solar reflectance** is the fraction of solar energy that is reflected by the roof surface.
- O. **Thermal emittance** is the fraction of thermal energy that is emitted from the roof surface.
- P. **A low-sloped roof** is a surface with a pitch less than 2:12 (less than 9.5 degrees from the horizon).
- Q. **A steep-sloped roof** is a surface with a pitch greater than or equal to 2:12 (9.5 degrees or greater from the horizontal).
- R. **Air leakage** is a measurement of heat loss and gain by infiltration and exfiltration through gaps and cracks in the envelope.
- S. **Infiltration** is the *unintentional* replacement of conditioned air with unconditioned air through leaks or cracks in the building envelope. It is a major component of heating and cooling loads. Infiltration can occur through holes and cracks in the building envelope and around doors and fenestration framing areas.

Reducing infiltration in the building envelope can result in significant energy savings, especially in climates with severe winter and summer conditions. It also can result in improved occupant comfort, reduced moisture intrusion, and fewer air pollutants.
- T. **Exfiltration** is uncontrolled outward air leakage from inside a building, including leakage through cracks, joints, and intersections, around windows and doors, and through any other exterior partition or duct penetration.
- U. **Ventilation** is the *intentional* replacement of conditioned air with unconditioned air through open windows and skylights or mechanical systems.

### 3.4.2 Air Sealing and Air Leakage §110.7, §150.0

#### 3.4.2.1 Joints and Other Openings §110.7

Air leakage through joints, penetrations, cracks, holes, openings around windows, doors, walls, roofs, and floors can result in higher energy use. The following openings in the building envelope shall be caulked, gasketed, weather stripped, or otherwise sealed:

1. Exterior joints around window and door frames (including doors between the house and garage), between interior HVAC closets and conditioned space, between attic access and conditioned space, between wall sill plates and the floor, exterior panels, and all siding materials.
2. Openings for plumbing, electricity, and gas lines in exterior and interior walls, ceilings, and floors.
3. Openings in the attic floor, such as where ceiling panels meet interior walls, exterior walls, and masonry fireplaces.
4. Openings around exhaust ducts, such as those for clothes dryers.
5. All other such openings in the building envelope.

**Figure 3-10: Air Sealing**

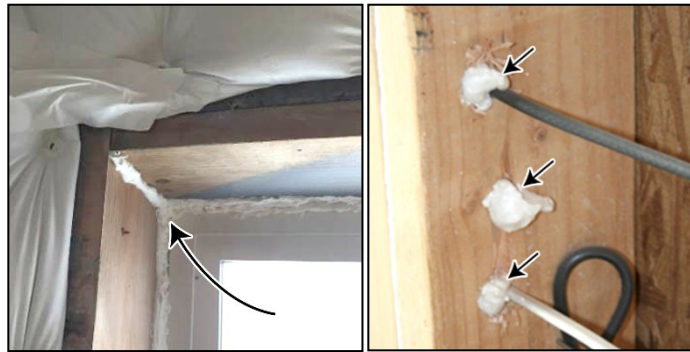

Source: Sierra Building Science

**Figure 3-11: Caulking and Weatherstripping**

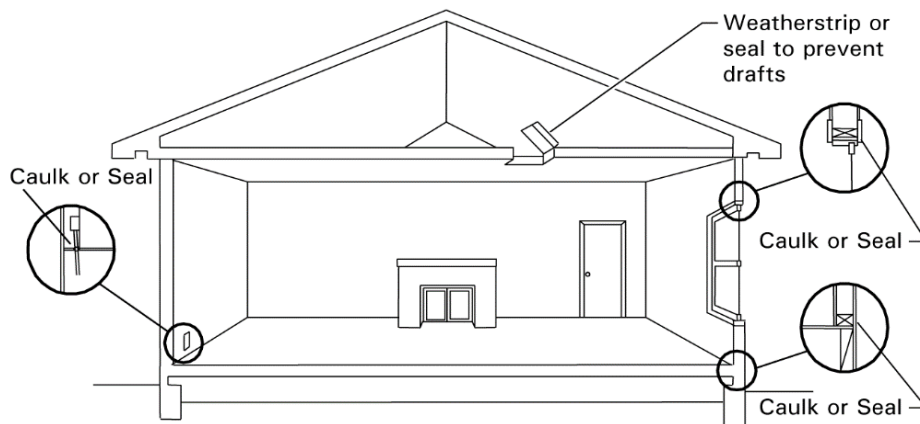

Source: California Energy Commission

**Note for Contractors/Installers:** Alternative strategies may be used to meet the mandatory caulking and sealing requirements for exterior walls.

These include, but are not limited to:

1. Stucco.
2. Caulking and taping all joints between wall components (for example, between slats in wood slat walls).
3. Building wraps.
4. Rigid wall insulation installed continuously on the exterior of the building with all joints taped, gasketed, or otherwise sealed.

#### **3.4.2.2 Fireplaces, Decorative Gas Appliances, and Gas Logs §150.0(e)**

The Energy Code has mandatory requirements to limit infiltration associated with fireplaces, decorative gas appliances, and gas logs. Reduced infiltration is a benefit when the fireplace is not operating (the majority of the time for most homes).

#### **3.4.3 Roofing Products §10-113, §110.8(i), §150.1(c)11**

In general, light-colored, high-reflectance surfaces reflect solar energy (visible light and invisible infrared and ultraviolet radiation) and stay cooler than darker surfaces that absorb the sun's energy and become heated. The Energy Code prescribes cool roof radiative properties for low-sloped and steep-sloped roofs. Low-sloped roofs receive more solar radiation than steep-sloped roofs in the summer when the sun is higher in the sky.

Roofing products installed to take compliance credit or meet the prescriptive requirements for reflectance and emittance shall be rated by the Cool Roof Rating Council (CRRC) and labeled appropriately by the roofing manufacturer for solar reflectance and thermal emittance. The solar reflectance and thermal emittance properties are rated and listed by the Cool Roof Rating Council at ([www.coolroofs.org/](http://www.coolroofs.org/)).

##### **3.4.3.1 Product Labels §10-113**

Figure 3-12 shows a sample Cool Roof Rating Council product label. The label includes solar reflectance and thermal emittance values.

**Figure 3-12: Sample CRRC Product Label and Information**

	<b>Solar Reflectance</b>	<b>Initial</b> <b>0.00</b>	<b>Weathered</b> <b>Pending</b>
	<b>Thermal Emittance</b>	<b>0.00</b>	<b>Pending</b>
	Rated Product ID Number	-----	
	Licensed Seller ID Number	-----	
Classification		Production Line	
<p>Cool Roof Rating Council ratings are determined for a fixed set of conditions, and may not be appropriate for determining seasonal energy performance. The actual effect of solar reflectance and thermal emittance on building performance may vary.</p> <p>Manufacturer of product stipulates that these ratings were determined in accordance with the applicable Cool Roof Rating Council procedures.</p>			

Source: Cool Roof Rating Council

Solar reflectance and thermal emittance are measured from 0 to 1; the higher the value, the "cooler" the roof. There are numerous roofing materials in a wide range of colors that have adequate cool roof properties. Reducing heat gains through the roof will reduce the cooling load of the home, resulting in reduced air-conditioned energy needed to maintain occupant comfort. High-emitting roof surfaces reject absorbed heat quickly (upward and out of the building) than roof surfaces with low-emitting properties.

**Solar Reflectance (SR).** There are three solar reflectance measurements:

1. Initial solar reflectance
2. Three-year aged solar reflectance
3. Accelerated aged solar reflectance

All requirements of the Energy Code are based on the three-year aged solar reflectance (SR). If the aged SR value is not available in the CRRC’s Rated Product Directory, then the aged value shall be derived from the CRRC aged value equation (using the initial value for solar reflectance) or an accelerated process. Until the appropriate aged-rated value for the reflectance is posted in the directory, the equation below can be used to calculate the aged rated solar reflectance, or a new method of testing is used to find the accelerated solar reflectance.

### Calculating Aged Solar Reflectance from Initial Reflectance

$$\text{Equation 3-1: Aged Reflectance}_{\text{calculated}} = (0.2 + \beta[\rho_{\text{initial}} - 0.2])$$

Where:

$\rho_{\text{initial}}$  = Initial Reflectance listed in the CRRC Rated Product Directory

$\beta$  = soiling resistance which is listed in Table 3-6

**Table 3-6: Values of Soiling Resistance  $\beta$  by Product Type**

PRODUCT TYPE	$\beta$
Field-applied coating	0.65
Other	0.70

Source: California Energy Commission

**Thermal Emittance (TE).** The Energy Code does not distinguish between initial and aged thermal emittance, meaning either value can be used to demonstrate compliance with the Energy Code.

**Note for Contractors/installers:** What is Solar Reflectance Index (SRI)?

An alternative to the aged solar reflectance and thermal emittance required values is to use the Solar Reflectance Index (SRI) to show compliance. A calculator has been produced to calculate the SRI by inputting the three-year aged solar reflectance and thermal emittance of the desired roofing material.

The calculator can be found at <http://www.energy.ca.gov/title24/2022standards>.

By using the SRI alternative, a cool roof may comply with a lower emittance, as long as the aged reflectance is higher, and vice versa.

#### Example 3-11: ENERGY STAR® Roofing Products

**Question:** I am a salesperson who represents several roofing products. Many of them are on the ENERGY STAR® list published by the U.S. Environmental Protection Agency (EPA) for cool roofing materials. Is this sufficient to meet the Energy Code?

**Answer:** No. ENERGY STAR has different requirements than the Energy Code for reflectance and no requirements for emittance. Per §10-113, the Cool Roof Rating Council ([www.coolroofs.org](http://www.coolroofs.org)) is the only entity recognized by the California Energy Commission to determine what qualifies as a cool roof.

#### Example 3-12: Certifying Products with the Cool Roof Rating Council (CRRC)

**Question:** How does a product get CRRC cool roof certification?

**Answer:** CRRC publishes its certification procedures in the CRRC-1 Program Manual, available for free at [www.coolroofs.org](http://www.coolroofs.org) or by calling CRRC at (866) 465-2523 (toll free within the USA) or (510)-485-7176. Anyone new to the certification process and wishing to have one or more products certified should contact CRRC by phone or by email at [info@coolroofs.org](mailto:info@coolroofs.org). Working with CRRC is strongly recommended; staff walks interested parties through the procedures.

---

---

### Example 3-13: Reflectance vs. Emittance

**Question:** I understand reflectance, but what is emittance?

**Answer:** Material that reflects the sun's energy will still absorb some of that energy as heat; there are no perfectly reflecting materials being used for roofing. The absorbed heat is given off (emitted) to the environment in varying amounts depending on the materials and surface types. This emittance is given a value between 0 and 1, and this value represents a comparison (ratio) between what a given material or surface emits and what a perfect blackbody emitter would emit at the same temperature.

A higher emittance value means more energy is released from the material or surface; scientists refer to this emitted energy as *thermal radiation*. *Emittance* is a measure of the relative efficiency with which a material, surface, or body can cool itself by radiation. Lower-emitting materials become relatively hotter due to holding in heat. Roof materials with low emittance hold onto more solar energy as heat, and that held heat can be given off downward into the building. More heat in the building increases the need for air conditioning for comfort. A cool roof system that reflects solar radiation (has high reflectance) and emits thermal radiation well (has high emittance) will result in a cooler roof and a cooler building with lower air-conditioning costs.

---

#### 3.4.3.2 Mandatory Requirements

- **Field-Applied Liquid Coatings §110.8(i)4**

There are several liquid products, including elastomeric coatings and white acrylic coatings, that qualify for field-applied liquid coatings. The Energy Code specifies minimum performance and durability requirements for field-applied liquid coatings. These requirements do not apply to industrial coatings that are factory-applied, such as metal roof panels. The requirements address elongation, tensile strength, permeance (rate of water vapor transmission), and accelerated weathering. The requirements depend on the type of coating and are described here in greater detail. Liquid roof coatings applied to low-sloped roofs in the field as the top surface of a roof covering shall comply with the following mandatory requirements and descriptions.

- **Aluminum-Pigmented Asphalt Roof Coatings.** Aluminum-pigmented coatings are silver-colored coatings that are commonly applied to modified bitumen and other roofing products. The coating has aluminum pigments that float to the surface of

the coating while it is setting, providing a shiny and reflective surface. Because of the shiny surface and the physical properties of aluminum, these coatings have a thermal emittance below 0.75, which is the minimum rating for prescriptive compliance.

This class of field-applied liquid coatings shall be applied across the entire surface of the roof and meet the dry mil thickness or coverage recommended by the manufacturer, depending on the substrate on which the coating will be applied. The aluminum-pigmented asphalt roof coatings shall be manufactured in accordance with ASTM D2824. Standard specification is also required for aluminum-pigmented asphalt roof coatings, non-fibered, asbestos-fibered, and fibered without asbestos that are suitable for application to roofing or masonry surfaces by brush or spray, and installed in accordance with ASTM D3805, *Standard Guide for Application of Aluminum-Pigmented Asphalt Roof Coatings*.

- **Cement-Based Roof Coatings.** This class of coatings consists of a layer of cement that may be applied to almost any type of roofing. Cement-based coatings shall be applied across the entire roof surface to meet the dry mil thickness or coverage recommended by the manufacturer. Cement-based coatings shall be manufactured to contain no less than 20 percent Portland cement and meet the requirements of ASTM D822, ASTM C1583, and ASTM D5870.
- **Other Field-Applied Liquid Coatings.** Other field-applied liquid coatings include elastomeric and acrylic-based coatings. These coatings must be applied across the entire roof surface to meet the dry mil thickness or coverage recommended by the manufacturer, depending on the substrate on which the coating will be applied. The field-applied liquid coatings must be tested to meet several performance and durability requirements as specified in Table 110.8-C of the Energy Code or the minimum performance requirements of ASTM C836, D3468, or D6694, whichever are appropriate to the coating material.

**3.4.3.3 Prescriptive Requirements §150.1(c)11**

Steep-sloped and low-sloped energy-efficient cool roofs are prescriptively required in some climate zones. The prescriptive requirement is based on an aged solar reflectance and thermal emittance tested value from the Cool Roof Rating Council (CRRC). If a cool roof is being installed to comply with the Energy Code, it must meet mandatory product and labeling requirements.

**Table 3-7: Prescriptive Cool Roof Requirements**

Roof Type	Climate Zone	Minimum Three-Year Aged Solar Reflectance	Minimum Thermal Emittance	Minimum SRI
Steep-sloped	10 through 15	0.20	0.75	16

Roof Type	Climate Zone	Minimum Three-Year Aged Solar Reflectance	Minimum Thermal Emittance	Minimum SRI
Low-sloped	13 and 15	0.63	0.75	75

Source: California Energy Commission

There are two exceptions to meeting these prescriptive requirements:

1. Roof area with building-integrated photovoltaic panels or building-integrated solar thermal panels.
- **OR**
2. Roof constructions that have a weight of at least 25 lb/ft<sup>2</sup>.
- The project could choose to pursue the performance approach and trade off the prescriptive cool roof requirements. See Section 3.6 and Chapter 8 for more on the performance approach.

#### 3.4.3.4 Compliance and Enforcement

The plans examiner should ensure that the aged solar reflectance and thermal emittance values documented on the CF1R-ENV-04 are specified on the building plans at the time of permit application.

The inspector can verify that the values on the CRRC label for the installed roof product meet or exceed the aged solar reflectance and thermal emittance values on the CF1R compliance document.

**Note for Building Inspectors:** If a manufacturer does not obtain a CRRC certificate for its roofing products, the following default aged solar reflectance and thermal emittance values must be used for compliance:

1. For asphalt shingles: 0.08 aged SR and 0.75 TE
2. For all other roofing products: 0.10 aged SR and 0.75 TE

#### 3.4.4 Radiant Barriers §110.8(j), §150.1(c)2

A radiant barrier is a reflective material that reduces radiant heat transfer into the attic caused by solar heat gain in the roof.

##### 3.4.4.1 Mandatory Requirements §110.8(j)

When a radiant barrier is installed, the product must meet mandatory requirements in §110.8(j).

The radiant barrier must have an emittance of 0.05 or less. The product must be tested according to ASTM C1371 or ASTM E408, and must be certified by the



Bureau of Household Goods and Services (BHGS) and listed in its Consumer Guide and Directory of Certified Insulation Material, at [https://bhgs.dca.ca.gov/consumers/ti\\_directory.pdf](https://bhgs.dca.ca.gov/consumers/ti_directory.pdf).

#### **3.4.4.2 Prescriptive Requirements §150.1(c)2, RA4.2.1**

The prescriptive requirements call for Option C vented attics to have a radiant barrier in climate zones 2 through 15, while Option B vented attics only require a radiant barrier in climate zones 2, 3, and 5 through 7.

**Installation.** The most common way of meeting the radiant barrier requirement is to use roof sheathing that has a radiant barrier bonded to it by the manufacturer. Some oriented strand board (OSB) products have a factory-applied radiant barrier. The sheathing is installed with the radiant barrier (shiny side) facing down toward the attic space.

Alternatively, a radiant barrier material that meets the same ASTM test and moisture perforation requirements that apply to factory-laminated foil can be field-laminated. Field lamination must use a secure mechanical means of holding the foil-type material to the bottom of the roof decking such as staples or nails that do not penetrate all the way through the roof deck material. Roofs with gable ends must have a radiant barrier installed on the gable ends to meet the radiant barrier requirement.

Other acceptable methods are to drape a foil type radiant barrier over the top of the top chords before the sheathing is installed, stapling the radiant barrier between the top chords after the sheathing is installed, and stapling the radiant barrier to the underside of the truss/rafters (top chord). For these installation methods, the foil must be installed with spacing requirements as described in Reference Appendices, Residential Appendix RA4.2.1.

Installation of radiant barriers is somewhat more challenging in the case of closed rafter spaces, particularly when roof sheathing is installed that does not include a laminated foil-type radiant barrier. Radiant barrier foil material may be field-laminated after the sheathing has been installed by “laminating” the foil to the roof sheathing between framing members. This construction type is described in the Reference Appendices, Residential Appendix RA4.2.1.1. See Figure 3-13 for drawings of radiant barrier installation methods.

For closed rafter spaces, such as a cathedral ceiling, the required air space for radiant barriers shall be provided and must meet the ventilation requirements of California Building Code (CBC), Title 24, Part 2.5, §R806.1.

**Figure 3-13: Methods of Installation for Radiant Barriers**

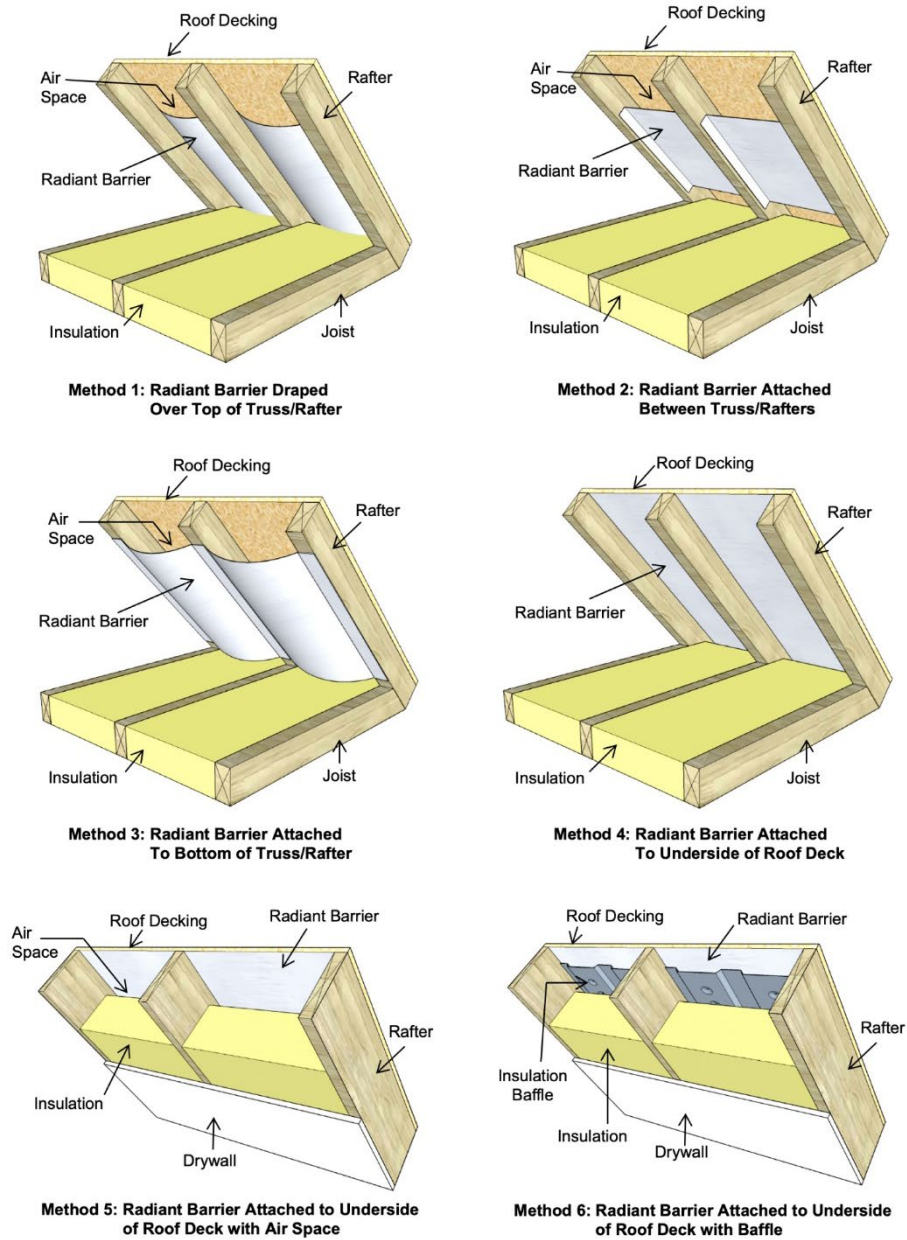

Source: California Energy Commission

### **Radiant Barriers in the Performance Approach**

In the performance approach, radiant barriers are modeled apart from the U-factor. The duct efficiency also is affected by the presence of a radiant barrier when using the performance approach. See more in Section 3.6 and Chapter 8.

### **3.4.5 Vapor Retarder §150.0(g) and RA4.5.1**

#### **When is a vapor retarder required?**

In climate zones 14 and 16, a continuous Class I or Class II vapor retarder, lapped or joint sealed, must be installed on the conditioned-space side of all insulation in all exterior walls, on the roof decks of vented attics with above-deck or below-deck air-permeable insulation, and in unvented attics with air-permeable insulation.

Buildings with unvented or controlled-ventilation crawl spaces in all climate zones must have a Class I or Class II vapor retarder placed over the earth floor of the crawl space to reduce moisture entry and protect insulation from condensation in accordance with Reference Appendices, Residential Appendix RA4.5.1.

### 3.4.5.1 Product Requirements

*Vapor retarder class* is a measure of the ability of a material or assembly to limit the amount of moisture that passes through the material or assembly. Vapor retarder classes are defined in Section 202 of the California Building Code (CBC). Testing for vapor retarder class is defined using the desiccant method of ASTM E96.

1. Class I: 0.1 perm or less
2. Class II:  $0.1 < \text{perm} \leq 1.0$  perm
3. Class III:  $1.0 < \text{perm} \leq 10$  perm

There are many product types having tested vapor retarder performance. Some common examples include the following:

1. Foil and other facings on gypsum board can provide moisture resistance, and product literature should always be checked to ensure conformance to ASTM E96.
2. The kraft paper used as facing on thermal batt insulation material is typically a Class II vapor retarder. Faced batts may have flanges for fastening to assembly framing. Fastening flanges may be face- or inset-stapled or not stapled at all, as the flanges provide no moisture control. Face stapling of flanged thermal batts helps ensure the insulation material is installed fully and properly within the framed cavity. Flangeless batts are also common and require no fastening as these materials maintain installation integrity through friction-fitting within the cavity of framed assemblies. In all cases, the insulation must be installed properly. See Figure 3-14.
3. Interior painted surfaces may also serve as vapor retarders if the paint product has been tested and shown to comply with the vapor retarder requirements. The effectiveness of vapor retarder paint depends upon the installed thickness (in mils). These products often require more than one layer to achieve the tested perm rating, and care must be shown by the installer of the paint and for inspection by the building official.

4. Closed-cell spray polyurethane foam (ccSPF) products can provide Class I or Class II vapor retarder performance, depending on thickness.

For all types of vapor retarders, care should be taken to seal penetrations, such as electrical outlets on exterior walls.

**Figure 3-14: Typical Kraft-Faced Vapor Retarder Facing**

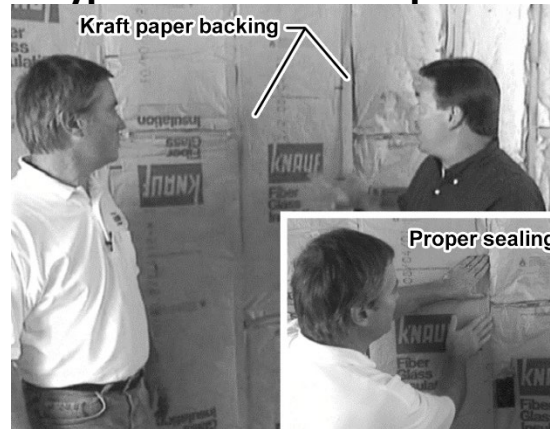

Source: California Energy Commission

### 3.5 Insulation Products

The Energy Code encourages the use of energy-saving techniques and designs for showing compliance. Insulation is one of the least expensive requirements to improve building energy efficiency. Insulation requires no maintenance, helps improve indoor comfort, and provides excellent sound control. Adding extra insulation later is more expensive than maximizing insulation levels at the beginning of construction. Innovative construction techniques and building products are being used more often by designers and builders who recognize the value of energy-efficient, high-performance buildings.

When the performance compliance method is used, an energy credit can be taken for design strategies that reduce building energy use below the standard design energy budget (compliance credit). Some strategies may require third-party verification by a HERS Rater; others do not. For more on the performance method, see Section 3.6 and Chapter 8.

**Table 3-8: Relevant Sections in the Energy Code**

	MANDATORY	PRESCRIPTIVE	PERFORMANCE
Insulation	§110.8(a) - (d), §110.8(g) - (h), §150.0(a) - (d), §150.0(f)	§150.1(c)1 Table 150.1-A	§150.1(a), §150.1(b)

### 3.5.1 Types of Insulation Products

There are four basic types of insulation or “insulation systems” installed in residential buildings: batt and blanket, loose-fill, spray polyurethane foam (SPF), and rigid insulation. The use varies based on the design and type of construction.

#### 3.5.1.1 Batt and Blanket

- Batt and blanket insulation are made of mineral fiber and mineral wool (processed fiberglass, rock, slag wool); animal wool or cotton-based products; or cellulose materials. These products are used to insulate below floors, above ceilings, below roofs, and within walls. They offer ease of installation with R-values set by the manufacturer based on size and thickness. They are available with facings, some serve as vapor retarders, and have flanges to aid in installation to framed assemblies. Many are available as unfaced material and can be easily friction-fitted into framed cavities.
- Batt and blanket insulation allow easy inspection, and installation errors can readily be identified and remedied, including breeches in the air barrier system that allow air leakage.

**Note for Contractors/Installers:** Care should always be taken to install insulation properly, filling the entire cavity and butting ends or sides of the batt material to ensure uniformity of installation. Batt and blanket insulation material must be delaminated or cut to allow for wiring, plumbing, and other penetrations within the cavity. See Section 3.5.

### 3.5.1.2 Loose-Fill Insulation

**Figure 3-15: Cellulose-Insulated**

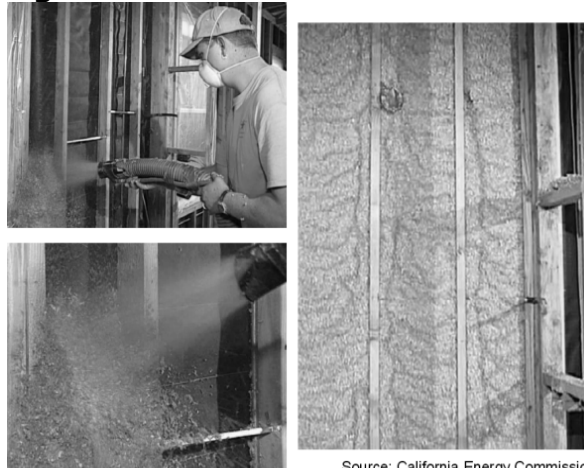

Source: California Energy Commission

Loose-fill is insulation that has a pneumatic or blown installation process, including cellulose, fiberglass, mineral wool and natural wool (animal or cotton-based products). Blown wall insulation can be an effective way to deal with the irregularities of wall cavities, especially the spaces around pipes, electric cables, junction boxes, and other equipment embedded in wall cavities (see Figure 3-15). The R-value of blown wall insulation material installed in closed cavities is determined by the installed thickness and density. This differs from manufactured products such as fiberglass or mineral wool batts for which the R-value has been tested and arrives at the construction site in preformed lengths and thicknesses with set R-values.

When installed in floors, walls, and other assemblies, these fibrous insulations are held in place in one of three ways:

1. Preinstalled netting or fabric
2. Use of existing cavity walls
3. Use of integral adhesives

**Note for Building Inspectors:** Blown wall insulation must be thoroughly checked to ensure the R-value is achieved. R-value depends on the installed density of the material at the building site, and the building official should ensure that the installed density meets manufacturer specifications. See Section 3.5.

#### **In closed cavities:**

- A line of sight down a wall section can hide imperfections in the installation, leading to underachieving stated R-values.
- Depressions and voids within the insulated cavity are areas lacking in R-value performance.

- Where netting is used, overspraying can result in a higher installed density (higher R-value) but can be troublesome for attaching gypsum board to wall framing.
- Where cavities have been underfilled, there may be voids or “soft” areas under the netting. These areas must be corrected by adding insulation, or the area must be removed, and new material must be blown into the cavity.

#### **In open cavities (attic floor or open wall):**

- No netting or preexisting wall cladding is needed (Figure 3-16).
- In open horizontal applications, such as attic floors, no adhesives are used, and the R-value is verified by the weight per square foot.
- In open vertical applications, integral adhesives are used to hold the fibers in place. Water-activated adhesives are used for moist-spray cellulose, and water or polymer adhesives are used for fiberglass loose-fill applications. The fiber and/or adhesive formulation cause the insulation to adhere to itself and stick to surfaces of the wall cavity.
- Excess insulation that extends past the wall cavity is scraped off and recycled.

**Figure 3-16: Attic Floor**



Source: California Energy Commission

#### **3.5.1.3 Spray Polyurethane Foam (SPF)**

- SPF is a two-part, liquid-foamed thermoset plastic (such as polyurethane). Polyurethane is formed by the reaction of an isocyanate and a polyol. Blowing agents, catalysts, and surfactants are added to develop a cellular structure before the polyurethane mixture cures. At application, the SPF material forms in place to provide insulation, an air seal, and, in closed-cell SPF, an integral vapor retarder and water barrier.
- SPF insulation is a two-component reactive system mixed at a spray gun or a single-component system that cures by exposure to humidity. The liquid is sprayed through a nozzle into the wall, roof, ceiling, and floor cavities. SPF insulation can be formulated to have specific physical properties, such as density, compressive strength, fire resistance, and R-value.

- SPF insulation is spray-applied to adhere fully to the substrate and other framing faces to form a complete air seal within the construction cavities.

**Note for Contractors/Installers:** SPF must be separated from the interior of the building, including attic spaces, by an approved thermal barrier complying with Section 316.4 of the California Residential Code (CRC).

- There are two common types of SPF insulation:

**Figure 3-17: Open-Cell SPF Installed in Wall Cavity**



Source: SPFA

- A. Low-Density Open-Cell SPF (ocSPF) Insulation:** A spray-applied polyurethane foam insulation having an open cellular structure resulting in an installed nominal density of 0.4 to 1.5 pounds per cubic foot (pcf), ocSPF has been assigned a default R-value of 3.6 per inch for compliance, but some products can achieve higher R-values. The ocSPF insulation is sprayed then expands to fill the framed cavity (Figure 3-17). Excess insulation may be trimmed by a special tool to simplify interior cladding installation. The average thickness of the foam insulation must meet or exceed the required R-value. Depressions in the foam insulation surface shall not be greater than 1/2-inch of the required thickness, provided these depressions do not exceed 10 percent of the surface area being insulated. Note: If using the default R-value of 3.6 per inch, the entire wall cavity must be filled to achieve the mandatory minimum wall insulation requirements for 2x4 and 2x6 framing.



**Figure 3-18: Closed-Cell SPF Installation in a Wall Cavity**



Source: SPFA

**B. Medium-Density Closed-Cell SPF (ccSPF) Insulation:** A spray-applied polyurethane foam insulation having a closed cellular structure resulting in an installed nominal density of greater than 1.5 to less than 2.5 pounds per cubic foot (pcf), ccSPF has been assigned a default R-value of 5.8 per inch for compliance, but some products can achieve higher R-values. The average thickness of the foam insulation must meet or exceed the required R-value. Depressions in the surface of the foam insulation shall not be greater than 1/2-inch of the required thickness at any given point of the surface area being insulated. ccSPF is not required to fill the cavity (Figure 3-18).

**Note for Building Inspectors:** SPF R-value depends on the installed thickness, and the building official should ensure the thickness and uniformity of the SPF material within each cavity of framed assemblies meets manufacturer specifications.

**Table 3-9: Required Thickness of SPF Insulation to Achieve Default R-Values  
Equation 3-2: Alternative Calculation for Total R-Value:**

<ul style="list-style-type: none"> <li>• Thickness of insulation multiplied by</li> </ul>	<ul style="list-style-type: none"> <li>• “Tested R-value per inch” as certified by the Department of Consumer Affairs, Bureau of Household Goods and Services</li> </ul>
---	--

Overall assembly U-factors are determined by selecting the assembly type, framing configuration, and cavity insulation rating from the appropriate Reference Appendices, Joint Appendix JA4 table, other approved method specified in JA4, or using the Energy Commission-approved compliance simulation software.

### 3.5.1.4 Rigid Insulation

- Rigid board insulation sheathing is made from fiberglass, mineral wool, expanded polystyrene (EPS), extruded polystyrene (XPS), polyisocyanurate (ISO), or polyurethane (PUR). It varies in thickness, and some products can provide up to R-6 per inch of thickness.

**Figure 3-19: Properly Installed Rigid Insulation with Sealant Tape**



Source: U.S. Environmental Protection Agency

This type of insulation is used for above-roof decks, exterior walls, cathedral ceilings, basement walls; as perimeter insulation at concrete slab edges; and to insulate special framing situations such as window and door headers and around metal seismic bracing. Rigid board insulation may also be integral to exterior siding materials. Properly sealed rigid insulation can be used continuously across an envelope surface to reduce air infiltration and exfiltration, and thermal bridging at framing.

**Note for Contractors/installers:** Proper installation of continuous rigid insulation may include button cap nails, furring strips, flashing, sealant tape, and design of the drainage plane. See Figure 3-19.

The 2022 California Building Code (CBC) provides guidance on fastener penetration depth, diameter, and spacing for exterior foam sheathing in Section R703.11.2. California Residential Code (CRC) Table 703.15.1 shows the fastener spacing for cladding attachment over foam sheathing to wood framing.

### 3.5.2 Insulation Product Requirements §110.8(a)

Manufacturers must certify that insulating materials comply with the *California Quality Standards for Insulating Materials* (California Reference Standards Code [CCR], Title 24, Part 12, Chapters 12-13), which ensure that insulation sold or installed in

California performs according to stated R-values and meets minimum quality, health, and safety standards.

**Note for Building Inspectors:** Builders and enforcement agencies shall use the California Department of Consumer Affairs *Directory of Certified Insulation Material* to verify the certification of the insulating material. If an insulating product is not listed in the current edition of the directory, contact the Department of Consumer Affairs, Bureau of Household Goods and Services, at (916) 999-2041 or by email at [HomeProducts@dca.ca.gov](mailto:HomeProducts@dca.ca.gov).

### **3.5.2.1 Urea Formaldehyde Foam Insulation §110.8(b)**

The mandatory requirements restrict the use of urea formaldehyde foam insulation. The restrictions are intended to limit human exposure to formaldehyde, a volatile and harmful organic chemical.

If foam insulation is used that has urea formaldehyde, it must be installed on the exterior side of the wall (not in the cavity of framed walls), and a continuous vapor retarder must be placed in the wall construction to isolate the insulation from the interior of the space. The vapor retarder must be 4-mil- thick (0.1 mm) polyethylene or equivalent.

### **3.5.2.2 Flame Spread Rating of Insulation §110.8(c)**

The *California Quality Standards for Insulating Materials* requires that exposed facings on insulation material be fire resistant and tested and certified not to exceed a flame spread index of 25 and a smoke development index of 450. Insulation facings must be in contact with the finished assembly surface or they are considered exposed applications and cannot be installed. Flame spread indexes and smoke development indexes are shown on the insulation or packaging material or may be obtained from the manufacturer.

### **3.5.3 Ceiling and Roof Insulation §110.8(d), §150(a)**

#### **3.5.3.1 Loose Fill Insulation in the Attic §150.0(b)**

Loose fill insulation must be blown in evenly, and insulation levels must be documented on the certificate of installation (CF2R). The insulation level can be verified by checking that the depth of insulation conforms to the manufacturer's coverage chart for achieving the required R-value. The insulation also must meet the manufacturer's specified minimum weight per ft<sup>2</sup> for the corresponding R-value.

**Note for Contractors/Installers:** When installing loose fill insulation, the following guidelines should be followed:

1. For wood trusses that provide a flat ceiling and a sloped roof, the slope of the roof should be 4:12 or greater to provide adequate access for installing the insulation. Insulation thickness near the edge of the attic will be

reduced with all standard trusses, but this is acceptable as long as the average thickness is adequate to meet the minimum insulation requirement.

2. If the ceiling is sloped (for instance, with scissor trusses), loose fill insulation can be used as long as the slope of the ceiling is no more than 4:12. If the ceiling slope is greater than 4:12, loose fill should be used only if the insulation manufacturer will certify the installation for the slope of the ceiling.
3. At the apex of the truss, a clearance of at least 30 inches should be provided to simplify installation and inspection.

### **3.5.3.2 Wet Insulation Systems §110.8(h)**

*Wet insulation systems* are roofing systems where the insulation is installed above the waterproof membrane of the roof. Water can penetrate this insulation material and affect the energy performance of the roofing assembly in wet and cool climates. In climate zones 1 and 16, the insulating R-value of continuous insulation materials installed above the waterproof membrane of the roof must be multiplied by 0.8, and installers must use the resulting value in choosing the table column in Reference Appendices, Joint Appendix JA4 for determining assembly U-factor (when using the Joint Appendix JA4 table to comply). See the footnotes for Tables 4.2.1 through 4.2.7 in the Reference Appendices, Joint Appendix JA4.

### **3.5.3.3 Recessed Luminaires §150.0(k)1C**

Luminaires recessed in insulated ceilings can create thermal bridging through the assembly. Not only does this degrade the performance of the ceiling assembly, but it can permit condensation on a cold surface of the luminaire if exposed to moist air, as in a bathroom. Refer to the Lighting Chapter 6 for more information regarding the applicable requirements for recessed luminaires.

Luminaires recessed in insulated ceilings must meet three requirements.

1. They must be listed as defined in the Article 100 of the California Electric Code for zero clearance insulation contact (IC) by Underwriters Laboratories or other testing/rating laboratories recognized by the International Code Council (ICC). This enables insulation to be in direct contact with the luminaire.
2. The luminaire must have a label certified as per §150.0(k)1Cii for airtight (AT) construction. Airtight construction means that leakage through the luminaire will not exceed 2.0 cfm when exposed to a 75 Pa pressure difference, when tested in accordance with ASTM E283.
3. The luminaire must be sealed with a gasket or caulk between the housing and ceiling.

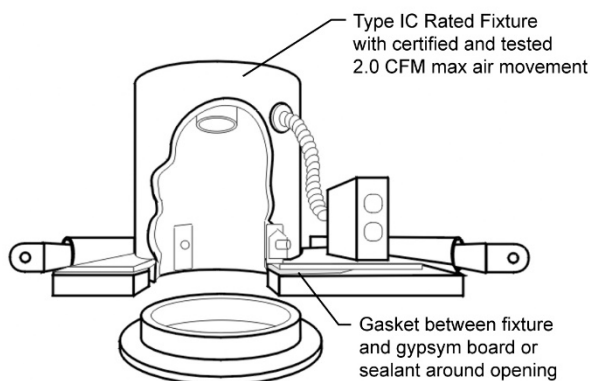
**Figure 3-21: IC-Rated Luminaire (Light Fixture)**

Source: California Energy Commission

### 3.5.3.4 Mandatory Requirements

Wood-framed roof/ceiling construction assemblies must have at least R-22 insulation or a maximum U-factor of 0.043 based on 16-inch-on-center wood-framed rafter roofs, as determined from Reference Appendices, Joint Appendix JA4. Some areas of the roof/ceiling can be greater than the maximum U-factor if other areas have a U-factor lower than the requirement and the weighted average U-factor for the overall ceiling/roof is 0.043 or less.

Metal-framed and roof/ceiling constructions other than wood-framed must have a U-factor of 0.043 or less to comply with the mandatory requirement. If the insulation is not penetrated by framing, such as rigid insulation laid over a structural deck, then the rigid insulation can actually have a rated R-value of less than R-22 so long as the total roof/ceiling assembly U-factor is not greater than U-0.043.

Newly constructed attics must have roof deck insulation in climate zones 4 and 8 through 16. Insulation may either be above or below the roof deck so long as the area-weighted average U-factor of the roof assembly is not greater than 0.184. This is equivalent to R-3 or R-4 insulation depending on the location of the insulation (above or below the roof deck) and the roof type. See Table 3-10 for examples of assemblies that can be constructed to meet the requirement. Exceptions to the mandatory roof deck insulation include: (1) if the space conditioning system air handler and ducts are located entirely in conditioned space (NOTE: Duct systems located in conditioned space can be uninsulated if specific conditions are met, as explained in Section 4.4.1 (§150.0(m)1B)), or (2) if no greater than 12 linear feet of supply duct, including the air handler and plenum are located in unconditioned space.

**Table 3-10: Examples of Wood-Framed Roof Assemblies and U-Factors, Assuming a Vented Attic**

Roofing	Above Deck Continuous Insulation	Below Deck Cavity Insulation	U-Factor <sup>1</sup>
Tile (10 PSF w/ airgap)	R-3	n/a	0.180
Tile (10 PSF w/ airgap)	n/a	R-3	0.184
Tile (10 PSF no airgap)	R-4	n/a	0.175
Tile (10 PSF no airgap)	n/a	R-4	0.181
Asphalt Shingle	R-4	n/a	0.178
Asphalt Shingle	n/a	R-4	0.184
Metal Tile	R-3	n/a	0.182
Metal Tile	n/a	R-4	0.159

<sup>1</sup>U-factor based on 2x4 at 24 inch on-center roof framing.

Source: California Energy Commission

**3.5.3.5 Prescriptive Requirements §150.1(c) and Table 150.1-A**

The 2022 Energy Code is designed to offer flexibility to the builders and designers of residential newly constructed buildings in terms of achieving the intended energy efficiency targets. As such, the Energy Code offers several options for achieving one of two design objectives related to improving energy performance of homes built with ventilated attics in climate zones 4, 8-16, as shown in Figure 3-22.

**Figure 3-22: Ventilating Attic Prescriptive Compliance Choices**

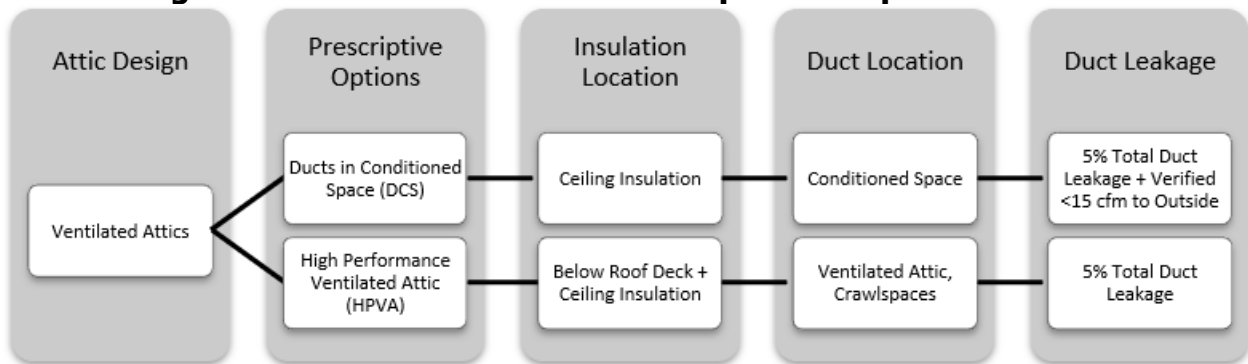

Source: California Energy Commission

**High Performance Ventilated Attic (HPVA).** This approach reduces temperature differences between the attic space and the conditioned air being transported through ductwork in the attic. The package consists of insulation below

the roof deck (Option B) in addition to insulation at the ceiling, R-6 or R-8 ducts, and 5 percent total duct leakage of the nominal air handler airflow.

**Ducts in Conditioned Space (DCS).** Ducts and air handlers are within the thermal and air barrier envelope of the building.

**Note for Contractors/Installers:** The Ducts in Conditioned Space (Option C) requires field verification by a HERS Rater to meet the prescriptive requirement.

All the prescriptive requirements for HPVA or DCS are based on the assumption that the home is built with the following construction practices:

1. The attic is ventilated with an appropriate free vent area as described below.
2. The roof is constructed with standard wood rafters and trusses.
3. For HPVA, the outermost layer of the roof construction is either tiles or a roofing product installed with an air gap between it and the roof deck.
4. The air handler and ducts are in the ventilated attic for HPVA and are in conditioned space for DCS.
5. The air barrier is located at the ceiling (excludes "cathedral" sealed attic roof/ceiling systems).

If a building design does not meet all of these specifications, it must comply through the performance approach.

---

### **Example 3--14: Cathedral Ceilings**

**Question:** If 5 percent of a roof will be a cathedral ceiling, can it still comply under the prescriptive requirements?

**Answer:** No. The entire attic must be a ventilated space with the building air barrier located at the ceiling with standard wood rafter trusses to comply with the prescriptive requirements. This project must comply through the performance approach.

---

---

### **Example 3-15: Unventilated Attics**

**Question:** Does an unventilated attic with insulation at the roof deck comply under the prescriptive requirements?

**Answer:** No. The entire attic must be a ventilated space with the building air barrier located at the ceiling with standard wood rafter trusses to comply with the prescriptive requirements. This project must comply through the performance approach.

---

---

### **Example 3-16: Insulation Above the Roof Deck**

**Question:** Does a ventilated attic with insulation above the roof deck comply under the prescriptive requirements?

**Answer:** No. The insulation must be located below the roof deck between the roof rafters to comply with the prescriptive requirements. If insulation is above the roof deck, the project must comply through the performance approach.

---

---

### **Example 3-17: Asphalt Shingles**

**Question:** A home with asphalt shingle roofing, having no air gap, has a ventilated attic with insulation installed below the roof deck between the roof rafters (HPVA) and at the ceiling meeting prescriptive insulation levels. Does this home comply with the prescriptive requirements?

**Answer:** No. The roofing product must be of a type that is installed with an air gap between the product and the roof deck, such as concrete tile, to comply with the prescriptive requirements. If a roofing product with no air gap between the product and the roof deck is installed, the project must comply through the performance approach.

---

---

### **Example 3-18: Gable Ends in High Performance Ventilated Attics**

**Question:** In addition to the roof underdeck, do gable end walls in high performance ventilated attics (HPVA) need to be insulated?

**Answer:** No. Gable end walls do not need to be insulated when designing and installing a HPVA.

---

---

### **Example 3-19: Attic Insulation Placement**

**Question:** When installing roof/ceiling insulation, does the insulation need to be installed on the entire roof/ceiling, including areas over unconditioned space?

**Answer:** It depends. The insulation should be installed at the roof/ceiling in one of the following ways:

(1) If the attic is an open or undivided space, then the entire roof/ceiling should be insulated. This includes portions of the roof/ceiling over an unconditioned space such as a garage.



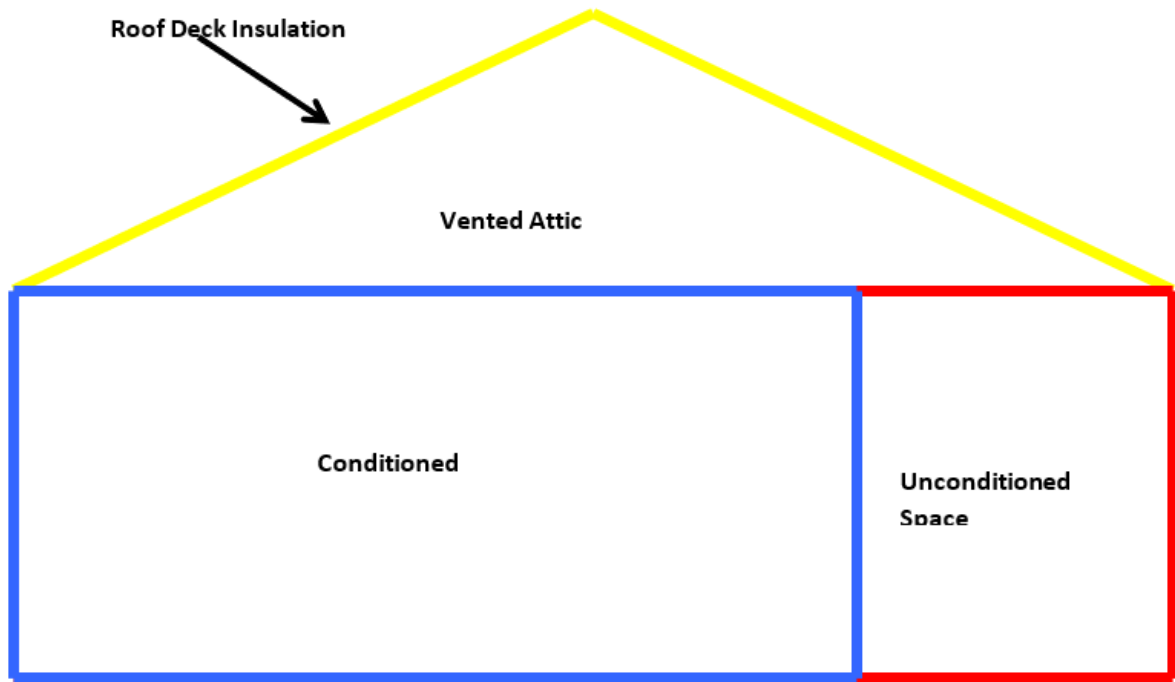

(2) If the attic has a continuous air barrier separating the attic over unconditioned space from the attic over conditioned space, then only the portions of the roof/ceiling over conditioned space should be insulated. It is recommended, but not required, that the air barrier also be insulated.

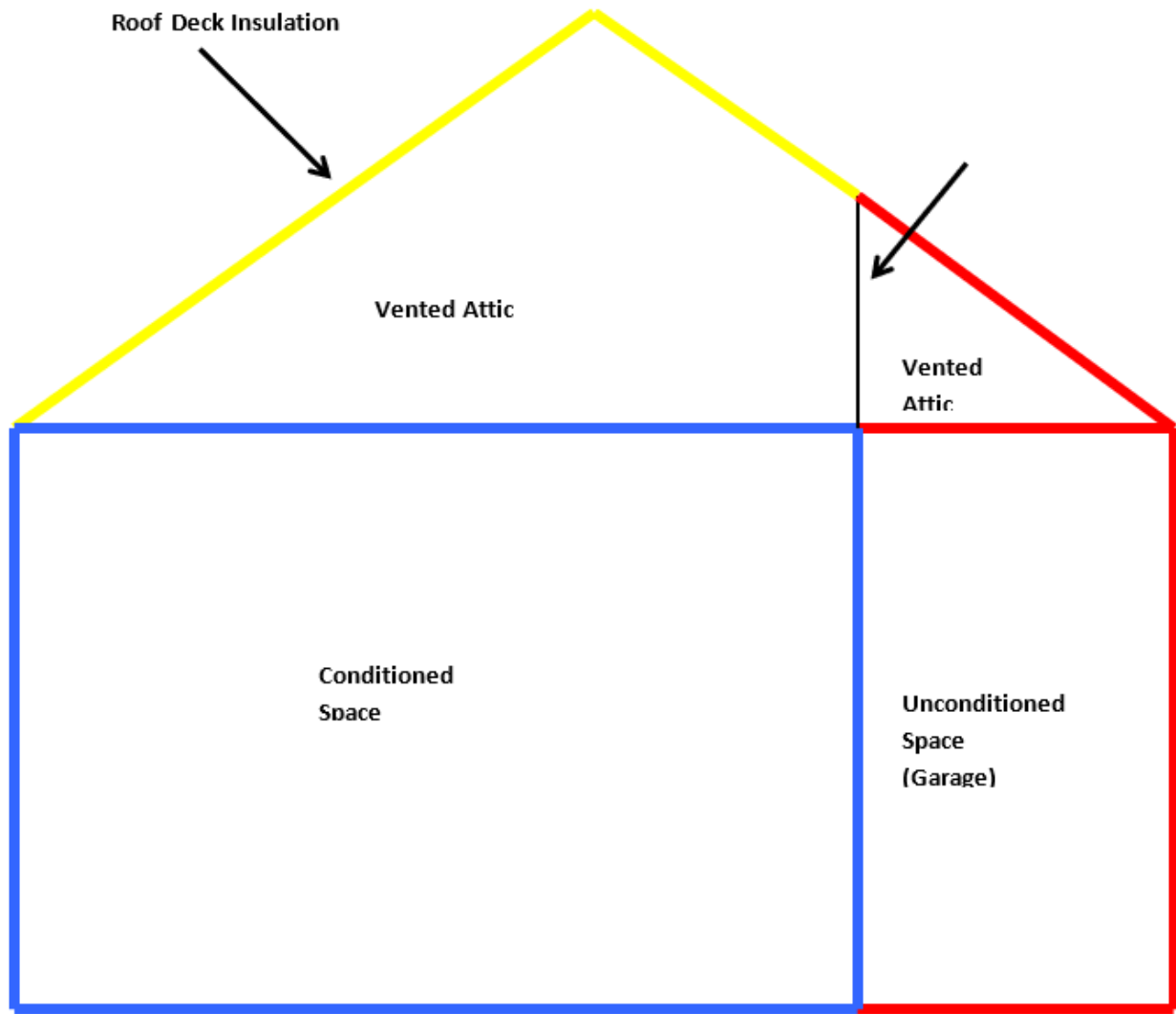

### 3.5.3.6 High Performance Ventilated Attics §150.1(c).1

This section describes the prescriptive requirements and approaches necessary for HPVA as they relate to roof/ceiling insulation. HVAC aspects of the HPVA including duct insulation and duct leakage are described in Chapter 4. Requirements and approaches to meet the ducts in conditioned space (DCS) are described in Chapter 4 of this manual.

Section 150.1(c).1 requires different values of roof and ceiling insulation, depending on whether the HPVA (Option B) or DCS (Option C) is chosen. Figure 3-23 shows a prescriptive requirements checklist for each option based on Tables 150.1-A.

**Figure 3-23: Prescriptive Insulation Options**

High Performance Ventilated Attics Option <b>B</b> <sup>1</sup>	Ducts in Conditioned Space Option <b>C</b>
<ul style="list-style-type: none"> <li><input type="checkbox"/> Vented attic</li> <li><input type="checkbox"/> R-19 (CZ 4, 8-16) <b>below roof deck</b> batt, spray in cellulose/fiberglass secured with netting, or spray foam</li> <li><input type="checkbox"/> R-38 (CZ 1, 2, 4, 8-16) ceiling insulation or R-30 (CZ 3, 5-7)</li> <li><input type="checkbox"/> Radiant barrier (CZ 2, 3, 5-7)</li> <li><input type="checkbox"/> Air space between roofing and the roof deck</li> <li><input type="checkbox"/> R-6 or R-8 duct insulation (climate zone specific)</li> <li><input type="checkbox"/> 5% total duct leakage</li> </ul>	<ul style="list-style-type: none"> <li><input type="checkbox"/> Vented attic</li> <li><input type="checkbox"/> R-38 (CZ 1, 11-16) ceiling insulation or R-30 (CZ 2-10)</li> <li><input type="checkbox"/> R-6 or R-8 ducts (climate zone-specific)</li> <li><input type="checkbox"/> Radiant barrier (CZ 2-15)</li> <li><input type="checkbox"/> HERS-verified ducts in conditioned space (5% Total Duct Leakage + Verified &lt;15 cfm to Outside)</li> </ul>
<ul style="list-style-type: none"> <li>• Table 150.1-A</li> <li>• <b>Assembly Option B</b></li> </ul>	<ul style="list-style-type: none"> <li>• Table 150.1-A/B</li> <li>• <b>Assembly Option C</b></li> </ul>

Note: 1 Option B is the standard design used to set the energy budget for the performance approach.

Source: California Energy Commission

- **Below Roof Deck Insulation Option B.** In a vented attic, air-permeable or air-impermeable insulation (batt, spray foam, loose-fill cellulose, or fiberglass) should be placed **directly** below the roof deck between the truss members and secured in place to provide a thermal break for the attic space. Insulation must be in direct contact with the roof deck and secured by the insulation adhesion, facing, mechanical fasteners, wire systems, a membrane material, or netting. Batts supported with cabling or other mechanical methods from below shall have supports that are less than or equal to 16" apart and no farther than 8" from the end of the batt.
- When batt thickness exceeds the depth of the roof framing members, full-width batts must be used to fit snugly and allow batts to expand beyond the framing members. Full coverage of the top chord framing members by insulation is recommended as best practice but is not required.

**Figure 3-24: Details of Option B Assembly**

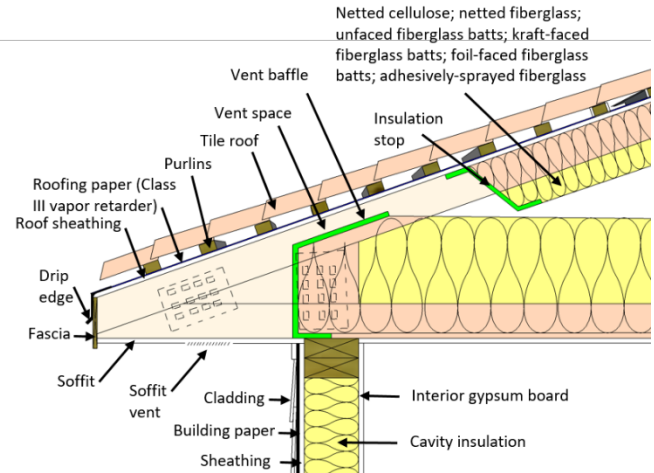

Source: California Energy Commission

**Figure 3--25: Placement of Insulation Below the Roof Deck**

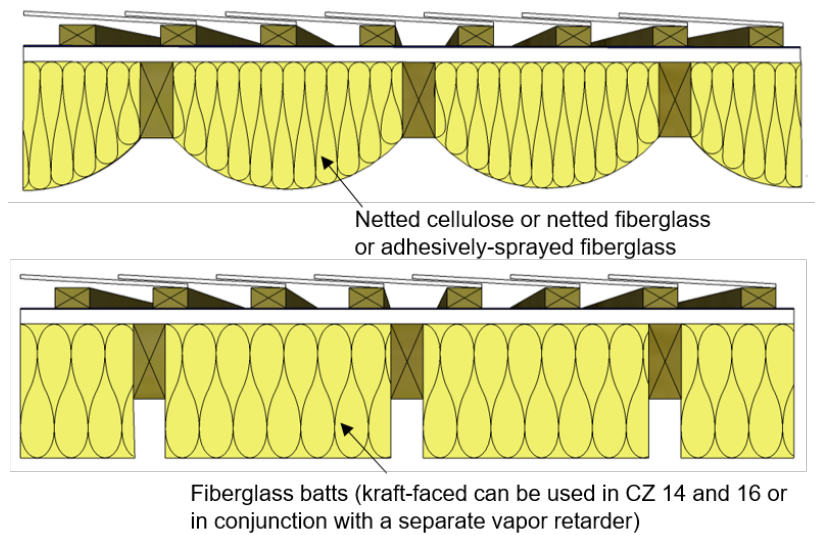

Source: California Energy Commission

When insulation is installed below the roof deck to meet the prescriptive requirements of Option B, a radiant barrier is not required. However, a draped radiant barrier may be installed to receive performance credit.

**Vapor Retarders (Option B).** Attic vapor retarders are not required by the Energy Code in most climates when using spray foam, blown-in insulation, or unfaced batts, and when sufficient attic ventilation is maintained. Although not required, the use of vapor retarders can provide additional security against possible moisture buildup in attic and framed assemblies. In climate zones 14 and 16, a Class I or Class II vapor retarder must

be used to manage moisture<sup>1</sup> as stated in California Building Code (CBC), Title 24, Part 2.5, Section R806.2.

### Attic Ventilation (Options B and C)

Proper attic ventilation occurs at two points at the roof: the soffit (or eave) vents and the ridge (or eyebrow) vents. Ridge or eyebrow venting must be maintained, as shown in Figure 3-26.

When installing insulation below the roof deck, vent baffles and insulation barriers should be used to maintain proper ventilation space. Proper airflow through the space helps remove moisture and prevents any associated issues.

**Figure 3-26: Insulation Air Baffles**

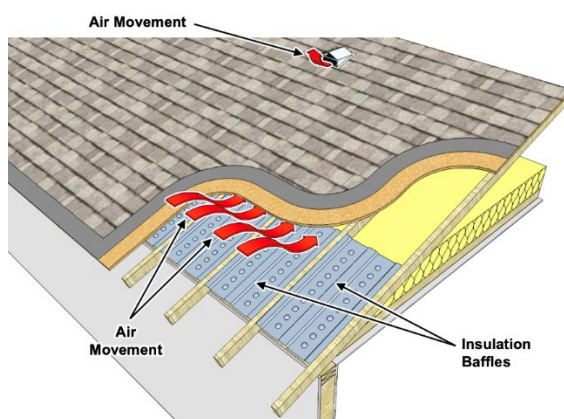

Source: Building Science Corporation

**Figure 3-27: Baffles at the Eave in Attics**

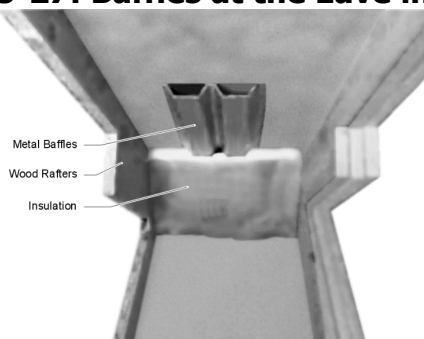

Source: California Energy Commission

Where ceiling insulation is installed next to eave or soffit vents, a rigid baffle should be installed at the top plate to direct ventilation air up and over the ceiling insulation. (See Figure 3-27.) The baffle should extend beyond the height of the ceiling insulation and

---

. 1 Insulation Contractors Association of America. (2004). Technical Bulletin No. 6 Use of Vapor Retarders.

should have sufficient clearance between the baffle and roof deck at the top. There are several acceptable methods for maintaining ventilation air, including preformed baffles made of either cardboard or plastic. In some cases, plywood or rigid foam baffles are used.

The California Building Code (CBC) requires a minimum vent area to be provided in roofs with attics, including enclosed rafter roofs creating cathedral or vaulted ceilings. Check with the local building jurisdiction to determine which of the two CBC ventilation requirements are to be followed:

1. CBC, Title 24, Part 2, Vol. 1, Section 1202.2 requires that the net-free ventilating area shall not be less than 1/300 of the area of the space ventilated.
2. CBC, Title 24, Part 2.5, Section R806.2 requires that the net-free ventilating area shall not be less than 1/150 of the area of the space ventilated. This ratio may be reduced to 1/300 if a ceiling vapor retarder is installed in climate zones 14 and 16. If meeting Option 1 above, a minimum of 40 percent and not more than 50 percent of the vents must be located in the upper portion of the space being ventilated at least 3 feet above the eave or cornice vents.

Insulation shall not block the free flow of air, and a minimum 1-inch air space shall be provided between the insulation and the roof sheathing and at the location of the vent.

Ventilated openings are covered with corrosion-resistant wire cloth screening or similar mesh material. When part of the vent area is blocked by meshes or louvers, the resulting “net-free area” of the vent must be considered to determine if ventilation requirements are met.

Many jurisdictions in California are covered by Wildland Urban Interface (WUI) regulations where specific requirements for construction materials must be used to improve fire resistance for the building. These regulations require special vents that are expressly tested to resist the intrusion of flames and burning embers. Check with the building department to ensure compliance with local codes.

---

### **Example 3--20: Installation Doesn't Match Compliant Design Option**

**Question:** A newly constructed building project in climate zone 12 with HVAC ducts in the attic was designed to meet the prescriptive requirements for below roof deck and ceiling insulation. Due to miscommunication amongst the team, the roof deck insulation was not installed, and R-49 ceiling insulation was installed instead. Does this project still comply?

**Answer:** This project no longer meets the prescriptive requirements and must follow the performance approach. For future projects, clearly communicating the project expectations to all team members early in the construction process is the key to succeeding at this design strategy. Having a project initiation meeting with all subcontractors and team members is a best practice, at least for the first few projects, until the entire team is aware of the design needs.

*Note: If the design was changed so that the roof deck has a radiant barrier and the HVAC equipment and ducts are verified to be in conditioned space, the altered design will meet the prescriptive requirements under Option C.*

---

### **Note for Contractors/Installers: Tips for Successfully Implementing the High Performance Attics Requirements**

- ✓ Commit to a compliance strategy early in the building design process.
- ✓ Have a kick-off meeting with builder, subcontractor, designer, energy consultant, and HERS Rater to set expectations and express the value of the design.
- ✓ Communicate strategy and schedule to subcontractors and other team members early.
- ✓ Include insulation specifications according to the CF1R on the building plans.
- ✓ Insulation contractor will install insulation below roof deck (ideally at the same time as ceiling insulation).
- ✓ All relevant subcontractors must be aware of where the air barrier is located and be conscious of where they make penetrations, especially if designing for verified ducts in conditioned space or reduced building envelope leakage.

**Duct and Air Handlers Located in Conditioned Space Option C.** Allows a project to place and verify that ducts are located in conditioned space instead of installing insulation at the roof deck. If complying with this option, ceiling and duct insulation must be installed at the values specified in Table 150.1-A for Option C, and a radiant barrier is required in most climate zones.

- **HERS Verification (Option C).** Simply locating ducts in conditioned space does not qualify for this requirement; a HERS Rater must test and verify for low leakage ducts within conditioned space and that the ducts are insulated to a level required in Table 150.1-A of the Energy Code.
- **Note for Architects/Designers:** Design strategies that can be used to prescriptively comply with Option C include dropped ceilings (dropped soffit), plenum or scissor truss to create a conditioned plenum box, and open-web floor truss. The key is that the ducts and equipment are placed within the air barrier of the building. Locating ducts within an unvented attic does not meet Option C requirements.
- **Ceiling Insulation (Options B and C).** Insulation coverage should extend far enough to the outside walls to cover the bottom chord of the truss. However, insulation should not block eave vents in attics because the flow of air through the attic space helps remove moisture that can build up in the attic and condense on the underside of the roof deck. This can cause structural damage and reduce the effectiveness of the insulation.

Based on area-weighted averaging, ceiling insulation may be tapered near the eave, but it must be applied at a rate to cover the entire ceiling at the specified level. An elevated truss is not required but may be desirable in some applications.

### 3.5.4 Wall Insulation

#### 3.5.4.1 Mandatory Requirements §150.0(c)

- **2x4 inch wood-framed walls above grade.** Shall have a U-factor not exceeding U-0.102. In a wood-framed wall, this requirement is met with at least R-13 insulation installed in the cavities between framing members.
- **2x6 inch or greater wood-framed walls above grade.** Shall have a U-factor not exceeding 0.071. In a wood-framed wall, this requirement is met with at least R-20 insulation installed in the cavities between framing members.

**Masonry walls above grade.** Must be insulated to meet the prescriptive requirements in Table 150.1-A for mass walls.

**All other wall types above grade.** Must meet a maximum U-factor of U-0.102.

**Demising partitions and knee walls.** Demising and knee walls must meet or exceed minimum insulation requirements listed above, depending on wall type.

**Exceptions:** There are several cases where the mandatory requirements for wall insulation do not apply or apply in a special way. For best practice, the following should be implemented:

1. The mandatory requirements apply to framed foundation walls of heated basements or heated crawl spaces that are located above grade, but not to the portion that is located below grade.
2. For additions to existing buildings, existing wood-framed walls that are not being altered and are already insulated to a U-factor of 0.110 or lower, or that have existing R-11 insulation need not comply with the mandatory R-13 wall insulation. For more on additions see Chapter 9.
3. Rim joists between floors of a multistory building are deemed to comply with these mandatory requirements if they have R-13 insulation installed on the inside of the rim joist and are properly installed between intersecting joist members.

#### Demising Partitions and Knee Walls

Demising partitions and knee walls are not required to meet the prescriptive package requirements. Demising partitions and knee walls shall meet the mandatory minimum wall insulation requirements from §150.0(c).



### 3.5.4.2 Prescriptive Requirements (Table 150.1-A)

#### 1. Framed Walls

The prescriptive requirements in Table 150.1-A call for a U-factor of 0.048 in climate zones 1-5 and 8-16, and a U-factor of 0.065 in climate zones 6 and 7.

The designer may choose any wall construction from Reference Appendices, Joint Appendix JA4 (Tables 4.3.1 and 4.3.4) that has a U-factor equal to or less than 0.048 or 0.065, depending on the climate zone.

**Wood Frame.** JA4 Table 4.3.4 shows that a 2x6 wood-framed wall at 16-inches-on-center can achieve a U-factor of 0.048 with R-21 batt insulation in the cavity and R-5 exterior insulation.

**Figure 3-28: Wood-Framed Wall With Brick Veneer**

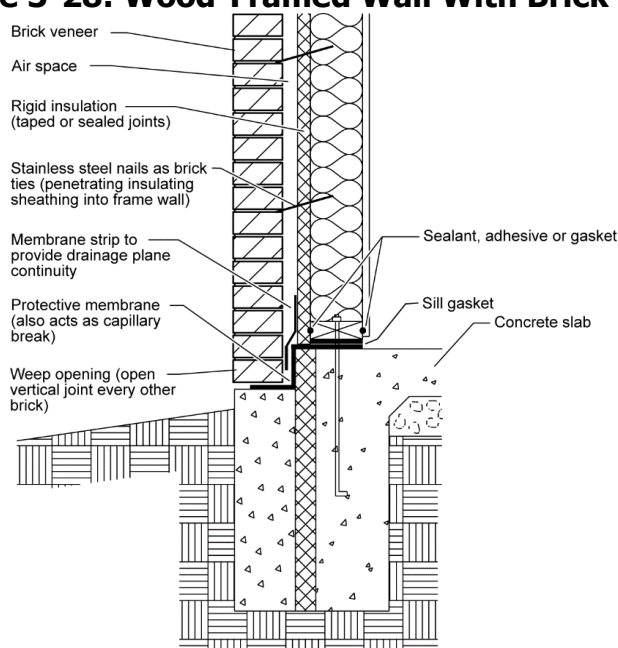

Source: California Energy Commission

Some examples of various wood-framed wall assemblies, associated construction, and U-values are provided in Table 3-11.

**Table 3-11: Examples of Wood-Framed Wall Assemblies and U-Factors, Assuming Gypsum Board Interior**

Stud (16" oc)	Cavity Insulation	Cavity Insulation Type	Exterior Insulation	U-Factor
2x4	R15	High density batt	R4	0.065
2x4	R13	Open-cell spray foam (ocSPF)	R5	0.064
2x4	R15	High density batt	R8	0.050

Stud (16" oc)	Cavity Insulation	Cavity Insulation Type	Exterior Insulation	U-Factor
2x6	R21	Loose-fill cellulose or high density batt	R4	0.051
2x6	R19	Low density batt	R5	0.051
2x6	R31	Closed-cell spray foam (ccSPF)	R2	0.049
2x6	R23	High density batt or mineral wool	R4	0.049
2x6	R21	Loose-fill cellulose or high density batt	R5	0.048
2x6	R19	Low density batt	R6	0.048
2x6	R23	High density bat or mineral wool	R5	0.047

**Metal Frame.** Metal-framed assemblies also will require rigid insulation to meet the maximum U-factor criteria. U-factors for metal-framed walls are given in Reference Appendices, Joint Appendix JA4 Table 4.3.4 and can also be calculated using Energy Commission-approved compliance software.

**Calculating U-factors.** U-factors can also be calculated by building the construction assembly in Commission-approved compliance software, including the inside finish, sheathing, cavity insulation, and exterior finish. Find approved compliance software here:

[http://www.energy.ca.gov/title24/2022standards/2022\\_computer\\_prog\\_list.html](http://www.energy.ca.gov/title24/2022standards/2022_computer_prog_list.html).

---

### Example 3-21: Prescriptive or Performance Approach for Wall Assembly?

**Question:** A new single-family house will have 2x6 framed walls with R-21 cavity insulation and R-5 continuous rigid insulation on the outside. Can this building comply with the Energy Code using either the prescriptive or performance approach?

**Answer:** If the house has wood framing, the assembly U-factor would be U-0.048 as per Reference Appendices, Joint Appendix JA4 Table 4.3.1. This U-factor prescriptively complies with the prescriptive U-factor requirements in all climate zones, and the building would not need to use the performance approach. If the house has metal framing, the assembly U-factor would be U-0.083 as per JA4 Table 4.3.4. This U-factor exceeds the maximum U-factor allowed in the prescriptive package and exceeds the mandatory maximum (U-0.071). The building would not comply regardless of the approach method used.

---

### Example 3-22: Wall Assembly Not Found in Joint Appendix JA4

**Question 1:** For a new wall, if 2 inches of medium-density, closed-cell spray polyurethane foam (ccSPF) is used in combination with R-13 batt insulation in the cavity of a 2x6 wood framed wall with 16" on center spacing, without continuous insulation added, what is the total U-factor for the wall assembly?

**Answer 1:** Medium-density ccSPF is given a default value of R-5.8 per inch, as per Reference Appendices, Joint Appendix JA4 Table 4.1.7. When 2 inches of ccSPF is added to R-13 batt insulation, the total cavity insulation is rounded to R-25. The assembly U-factor was calculated to be 0.065 using Commission-approved compliance software:

**Question 2:** Does this assembly meet prescriptive compliance requirements in climate zones 6 and 7?

**Answer 2:** Yes. The assembly does meet the minimum mandatory wall insulation U-factor requirement of 0.071, as well as the prescriptive U-factor requirement of 0.065 in climate zones 6 and 7.

*CBECC-Res Software Wall Assembly Construction  
showing U-0.065 Assembly*

The screenshot shows the 'Construction Data' tab in the CBECC-Res software. The 'Currently Active Construction' is 'Exterior Wall Cons'. The 'Construction Name' is 'Exterior Wall Cons', 'Can Assign To' is 'Exterior Walls', and 'Construction Type' is 'Wood Framed Wall'. The 'Construction Layers (inside to outside)' are defined for two paths: 'Cavity Path' and 'Frame Path'. The 'Cavity Path' includes 'Gypsum Board' (Inside Finish), 'no sheathing/insul.' (Sheathing / Insulation), 'R 25' (Cavity / Frame), 'no sheathing/insul.' (Sheathing / Insulation), and 'select finish' (Exterior Finish). The 'Frame Path' includes 'Gypsum Board' (Inside Finish), 'no sheathing/insul.' (Sheathing / Insulation), '2x6 @ 16 in. O.C.' (Cavity / Frame), 'no sheathing/insul.' (Sheathing / Insulation), and 'select finish' (Exterior Finish). There are checkboxes for 'Non-Standard Spray Foam in Cavity' and 'Specify Non-std Framing Factor', both of which are unchecked. At the bottom, the 'Winter Design U-value' is displayed as '0.065 Btu/h-ft2-F (meets max code 0.065 U-value (0.065))'.

**Question 3:** How about in other climate zones?

**Answer 3:** No. The assembly does not meet the prescriptive compliance U-factor requirement of 0.048 in climate zones 1-5 and 8-16 for single-family homes. To meet the prescriptive requirement for those climate zones, other wall assemblies may be used, and/or advanced wall system (AWS) techniques may be used to reduce the framing factor. Alternatively, the project may be shown to comply with the Energy Code using the performance approach. For more on the performance approach, see Section 3.6

## 2. Mass Walls

- **Location of Insulation.** The prescriptive requirements have separate criteria for mass walls with interior insulation and mass walls with exterior insulation. "Interior"

denotes that insulation is installed on the interior surface of the mass wall, and “exterior” denotes that insulation is installed on the exterior surface of the mass wall. Mass walls with insulation applied in locations other than directly to the interior or exterior, such as concrete sandwich panels, must meet the requirements for mass walls with exterior insulation. Mass walls with insulation applied to both the interior and exterior, such as insulated concrete forms (ICF), must meet the requirements for mass walls with interior insulation. Placement of insulation on mass walls will affect the thermal mass properties of a building. When the prescriptive compliance approach is used, the continuous insulation must be installed integral with or on the exterior or interior of the mass wall.

**Calculating the U-Factor.** To calculate the effective U-factor of a furred wall using the tables in Reference Appendices, Joint Appendix JA4:

1. Select a U-factor from JA4 Table 4.3.5 (Hollow Unit Masonry) or 4.3.6 (Solid Unit Masonry or Concrete) consistent with the type of wall.
2. Select the appropriate effective R-value for interior or exterior insulation layers from JA4 Table 4.3.14.
3. Use Equation 4-1, and the values selected, to calculate the U-factor of the construction assembly with the continuous insulation.
4. Compare the U-factor; it must be equal to or greater than the mass prescriptive U-factor from the Energy Code Table 150.1-A to comply.

**Note for Architects/Designers:** The U-factor of furred concrete or masonry walls also can be determined by building the construction assembly in Commission-approved compliance software.

- **Compliance and Enforcement for Insulation Installation in Framed Assemblies.**
- Documentation of insulation R-values and assembly U-factors includes product data sheets, manufacturer specifications and installation guidelines, insulation product and assembly testing information, and U-factor calculations following the procedures specified in Reference Appendices, Joint Appendix JA4 or from results of approved performance compliance computer software.
- The plans examiner should verify that the insulation R-value for walls (cavity and/or continuous) on the CF1R document is specified on the building plans and compliant with Table 150.1-A.
- The building inspector should verify the installed wall insulation meets or exceeds the R-value on the CF1R document.

Batt and loose fill insulation should fill the wall cavity evenly. If kraft or foil-faced insulation is used, it should be installed per manufacturer recommendations to minimize air leakage and avoid sagging of the insulation.

Wall insulation should extend into the perimeter floor joist (rim joist) cavities along the same plane as the wall. If a vapor retarder is required, it must be installed on the conditioned space side of the framing.

**Figure 3-29: Masonry Wall with Furring Details**

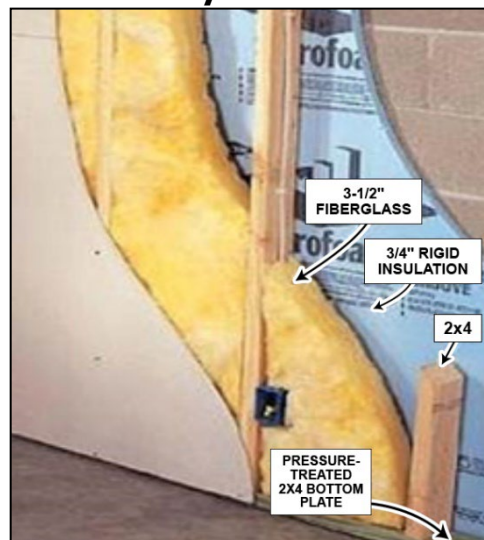

Source: California Energy Commission

**Note for Building Inspectors:** Because it is difficult to inspect wall insulation behind tub and shower enclosures after the enclosures are installed, insulation of these wall sections should be inspected during the framing inspection.

---

### Example 3--23: Minimum Insulation for Block Walls

**Question:** Do new residential buildings or additions consisting of block walls (for example, converting a garage into living space) need to comply with the R-13 minimum wall insulation requirement? If not, what insulation R-value do they need?

**Answer:** Block walls are considered masonry walls, and according to §150.0(c)3, the wall must have a U-factor not exceeding that required in Tables 150.1-A.

---

## 3.5.5 Raised-Floor Insulation §150.0(d)

### 3.5.5.1 Mandatory Requirements

Wood-framed floors over unconditioned space, regardless of whether there is a crawlspace, must have at least R-19 insulation installed between framing members, or the construction must have a U-factor of 0.037 or less. The equivalent U-factor is based on R-19 insulation in a 2x6, 16 inch on center wood-framed floor with a crawlspace.

Other types of raised floors, except for concrete raised floors (concrete raised floors do not have a mandatory requirement but do have a prescriptive requirement) must also meet the maximum U-factor. In all cases, some areas of the floor can have a U-

factor greater than the requirement as long as other areas have a U-factor that is lower than the requirement and the area-weighted average U-factor is less than that described above.

Raised slab floors with radiant heat (heated slab floors) must meet special insulation requirements that are described in Chapter 4 of this manual.

**Note for Contractors/Installers:** When a controlled ventilated or an unvented crawlspace is used, raised-floor insulation is not required, although a vapor retarder is required over the ground, and the foundation walls must be insulated.

**3.5.5.2 Prescriptive Requirements**

The prescriptive requirements differ for concrete raised floors and wood-framed floors. While the requirements for framed floors are the same in all climate zones, the requirements for concrete raised floors differ.

**Framed Raised Floors.** Table 150.1-A (prescriptive requirements) call for a minimum of R-19 insulation installed between wood framing or a maximum area-weighted average U-factor of 0.037 for framed raised floors in all climate zones. The requirement may be satisfied by installing the specified amount of insulation in a wood-framed floor or by meeting an equivalent U-factor. U-factors for raised floor assemblies are listed in Reference Appendices, Joint Appendix JA4.4.

**Table 3-12: Wood-Framed Raised Floor Constructions Meeting Prescriptive Requirements**

Insulation R-Value	Crawlspace?	Reference Joint Appendix JA4 Construction and Table Cell Entry	Equivalent U-Factor
R-19	No	4.4.2 A4	0.049
R-19	Yes	4.4.1 A4	0.037

Source: California Energy Commission

**Concrete Raised Floors.** Insulation requirements for concrete raised floors differ by climate zone, summarized in Table 3-13.

**Table 3-13: Insulation Requirements for Concrete Raised Floors per Table 150.1-A**

Climate Zone	1,2,11,13,14,16	12,15	3-10
U-Factor	≤ 0.092	≤ 0.138	≤ 0.269
R-Value of Continuous Insulation	≥ R-8	≥ R-4	No Req.

Source: California Energy Commission

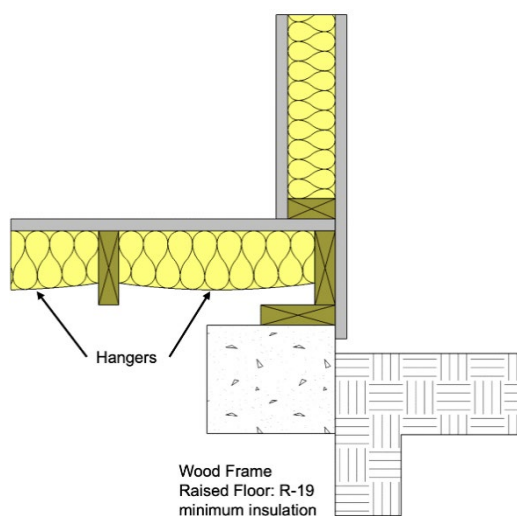
**Figure 3-30: Raised Floor Insulation**

Source: California Energy Commission

- **Installation.** Floor insulation should be installed in direct contact with the subfloor so that there is no air space between the insulation and the floor. Support is needed to prevent the insulation from falling, sagging, or deteriorating.
- Options for support include netting stapled to the underside of floor joists, insulation hangers running perpendicular to the joists, or other suitable means. Insulation hangers should be spaced at 18 inches or less before rolling out the insulation. See Figure 3-30. Insulation hangers are heavy wires up to 48 inches long with pointed ends, which provide positive wood penetration. Netting or mesh should be nailed or stapled to the underside of the joists. Floor insulation should not cover foundation vents.

### 3.5.6 Slab Insulation

#### 3.5.6.1 Mandatory Requirements §150.0(f)

##### Slab Insulation Products

The mandatory requirements state that the insulation material must be suitable for the application. Insulation material in direct contact with soil, such as perimeter insulation, must have a water absorption rate no greater than 0.3 percent when tested in accordance with ASTM C272 Test Method A, 24-Hour Immersion, and a vapor permeance no greater than 2.0 perm/inch when tested in accordance with ASTM E96.

The insulation must be protected from physical and UV degradation by either installing a water-resistant protection board, extending sheet metal flashing below grade, choosing an insulation product that has a hard durable surface on one side, or by other suitable means.

The top of the insulation must be protected with a rigid material to prevent intrusion of insects into the building foundation.

A common location for the slab insulation is on the foundation perimeter (Figure 3-31). Insulation that extends downward to the top of the footing is acceptable. Otherwise, the insulation must extend downward from the level of the top of the slab, down 16 inches (40 cm) or to the frost line, whichever is greater.

For below-grade slabs, vertical insulation shall be extended from the top of the foundation wall to the bottom of the foundation (or the top of the footing) or to the frost line, whichever is greater.

**Figure 3-31: Perimeter Slab Insulation**

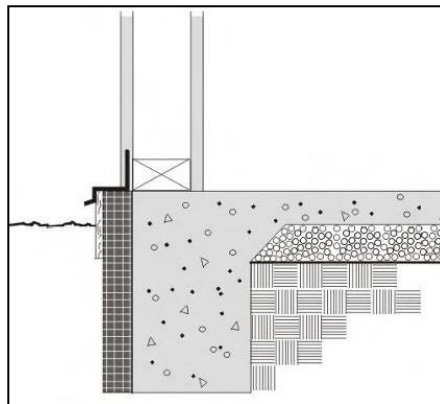

Source: California Energy Commission

**Heated Slab Floor Insulation §110.8(g)**

Heated slab-on-grade floors must be insulated according to the requirements in Table 110.8-A and Table 3-14.

One option is to install the insulation between the heated slab and foundation wall. In this case, insulation must extend downward to the top of the footing and then extend horizontally inward four feet toward the center of the slab. R-5 vertical insulation is required in all climates except climate zone 16, which requires R-10 of vertical insulation and R-7 horizontal insulation.

**Table 3-14: Slab Insulation Requirements for Heated Slab Floors**

Insulation Location	Insulation Orientation	Installation Requirements	Climate Zone	Insulation R-Value
Outside edge of heated slab, either inside or outside the foundation wall	Vertical	From the level of the top of the slab, down 16 inches or to the frost line, whichever is greater. Insulation may stop at the top of the footing, where this is less than the required depth. For below-	1 – 15	5
			16	10



Insulation Location	Insulation Orientation	Installation Requirements	Climate Zone	Insulation R-Value
		grade slabs, vertical insulation shall be extended from the top of the foundation wall to the bottom of the foundation (or the top of the footing) or to the frost line, whichever is greater.		
Between heated slab and outside foundation wall	Vertical and Horizontal	Vertical insulation from top of slab at inside edge of outside wall down to the top of the horizontal insulation. Horizontal insulation from the outside edge of the vertical insulation extending 4 feet toward the center of the slab in a direction normal to the outside of the building in plain view.	1 – 15 16	5 10 vertical and 7 horizontal

Source: California Energy Commission

**3.5.6.2 Prescriptive Requirements**

Table 150.1-A of the Energy Code requires slab insulation only in climate zone 16 for unheated slabs. All heated slabs must meet mandatory insulation requirements in §110.8(g).

For unheated slabs in climate zone 16, a minimum of R-7 slab-edge insulation or a maximum U-factor of 0.58 must be achieved. The insulation must be installed to a minimum depth of 16 inches or to the bottom of the footing, whichever is less. The depth is measured from the top of the insulation, as near the top of slab as practical, to the bottom edge of the insulation. See Figure 3-32.

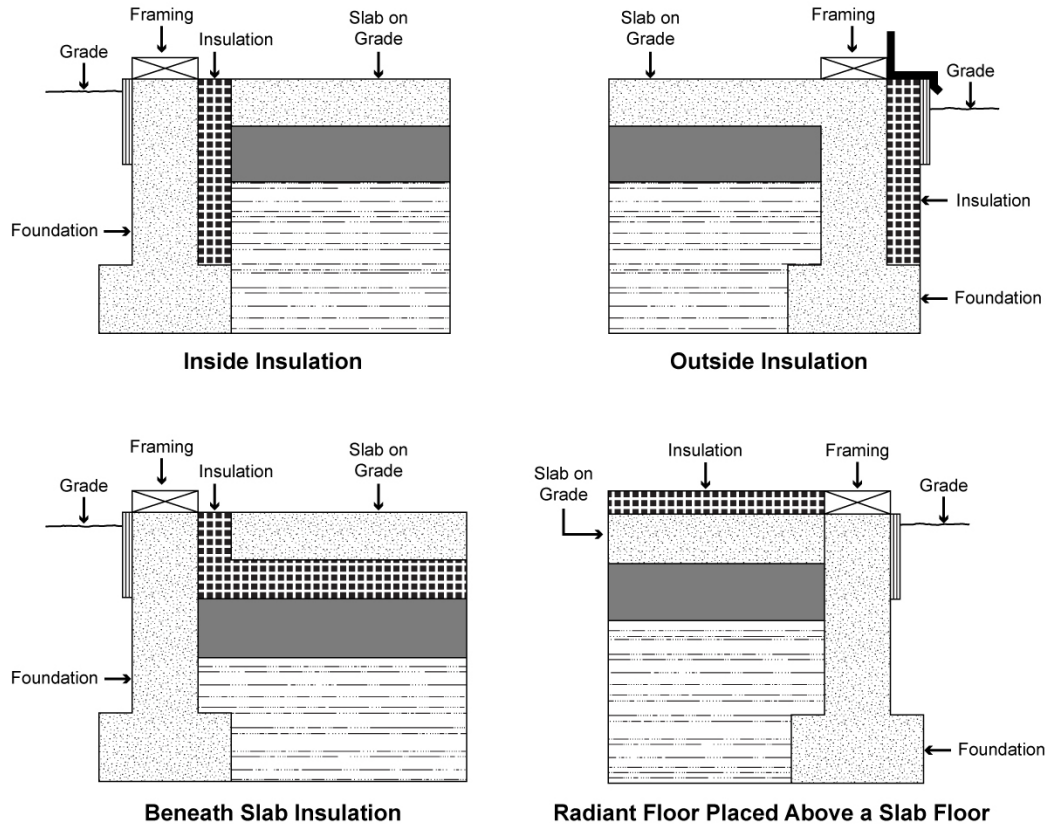
**Figure 3-32: Allowed Slab Edge Insulation Placement**

Source: California Energy Commission

**Note for Contractors//Installers:** Perimeter insulation is not required along the slab edge between conditioned space and the concrete slab of an attached unconditioned enclosed space such as a garage, covered porch, or covered patio. Neither would it be practical or necessary to insulate concrete steps attached to the outside slab edge.

---

**Example 3--24: Heated Slab Insulation**

**Question:** What are the slab edge insulation requirements for a hydronic-heating system with the hot water pipes in the slab?

**Answer:** The requirements for insulation of heated slabs can be found in §110.8(g) of the Energy Code and are described in Section 3.5.6.1 of this manual. The material and installation specifications are as follows:

1. Insulation values as shown in Table 110.8-A of the Energy Code
  2. Protection from physical damage and UV light deterioration
  3. Water absorption rate no greater than 0.3 percent (ASTM C272)
  4. Water vapor permeance no greater than 2.0 perm/inch (ASTM E96)
- 

**3.5.7 Thermal Mass**

**Thermal mass** consists of exposed tile floors over concrete, mass walls such as stone or brick, and other heavy elements within the building envelope that stabilizes indoor temperatures. Thermal mass helps temper interior temperature, storing heat or cooling for later use. In California's Central Valley and desert climates, the summer temperature range between night and day can be 30°F or more, and thermal mass can be an effective strategy to reduce daytime cooling loads.

Mass walls typically fall into two categories:

- **Masonry.** Masonry includes clay and concrete units, which may be solid or hollow, and glazed or unglazed. Other masonry unit types include cast stone and calcium silicate units. Concrete masonry units (CMU) are made from a mixture of Portland cement and aggregates under controlled conditions. Concrete masonry units can be manufactured in different sizes and with a variety of face textures.
- **Concrete and concrete sandwich panels.** Concrete and concrete sandwich panels typically use a precast form by casting concrete in a reusable mold or "form" that is then cured in a controlled environment, transported to the construction site, and lifted into place. Precast stone is distinguished from precast concrete by using a fine aggregate in the mixture, giving the appearance of naturally occurring rock or stone.

When thermal mass exists in exterior walls, it stabilizes temperatures in two ways. First, there is a time delay between when the outside temperature of the wall reaches its peak and when the inside of the wall reaches its peak. For an 8-inch to 12-inch concrete wall, this time delay is between 6 to 10 hours. Second, there is a dampening effect whereby the temperature range inside the house is less than the temperature range outside the house. These effects are illustrated in the Figure 3-33.

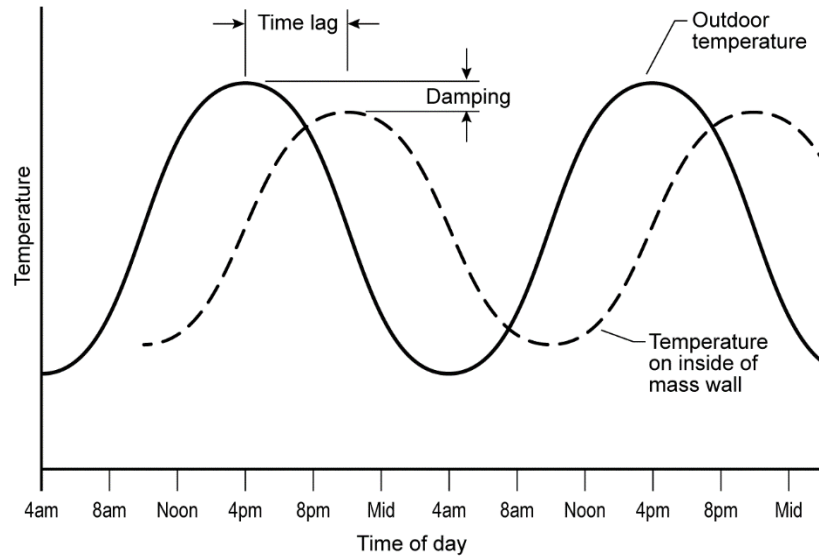
**Figure 3-33: Thermal Mass Performance**

Source: California Energy Commission

When the performance method is used, credit is offered for increasing thermal mass in buildings. This procedure is automated in Energy Commission-approved computer compliance software. See Section 3.6 for the performance method.

### 3.5.8 Quality Insulation Installation (QII) RA 3.5

Prescriptive Requirements (Table 150.1-A)

The prescriptive requirements shown in Table 150.1-A calls for QII in all climate zones for newly constructed buildings and additions greater than 700 square feet.

All insulation shall be installed properly throughout the building. A third-party HERS Rater is required to verify the integrity of the installed insulation. The installer shall provide evidence to the HERS Rater using compliance documentation that all insulation specified is installed to meet specified R-values and assembly U-factors.

To meet QII, two primary installation criteria must be adhered to, and they both must be field-verified by a HERS Rater. They include air sealing of the building enclosure (including walls, ceiling/roof, and floors), as well as proper installation of insulation. Refer to Reference Appendices, Residential Appendix RA3.5 for more details.

**Many residential insulation installations have flaws that degrade thermal performance. Four problems are generally responsible for this degradation:**

1. There is an inadequate air barrier in the building envelope or holes and gaps within the air barrier system that inhibit the ability to limit air leakage.
2. Insulation is not in contact with the air barrier, creating air spaces that short-circuit the thermal break of the insulation when the air barrier is not limiting air leakage properly.
3. The insulation has voids or gaps, resulting in portions of the construction assembly that are not properly insulated and, therefore, have less thermal resistance than other portions of the assembly (Figure 3-34).
4. The insulation is compressed, creating a gap near the air barrier and/or reducing the thickness of the insulation.

**Figure 3--34: Examples of Poor Quality Insulation Installation**

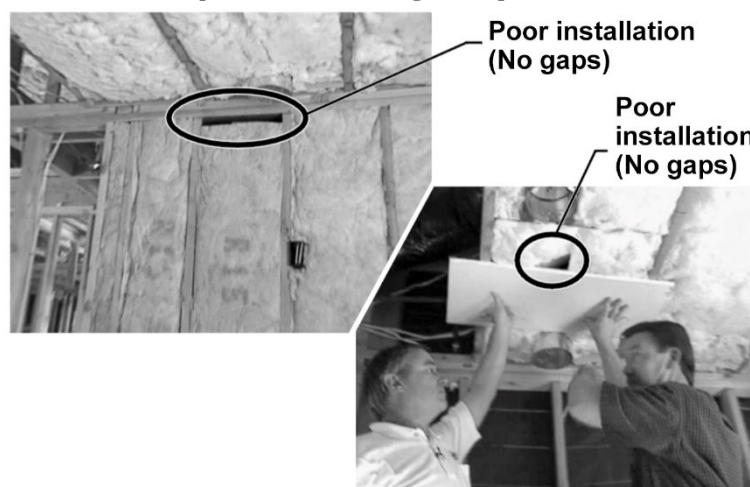

QII requires third-party HERS inspection to verify that an air barrier and insulation are installed correctly to eliminate or reduce common problems associated with poor installation. Guidance for QII is provided in Reference Appendices, Residential Appendix RA3.5. QII applies to framed and nonframed assemblies. Residential construction may incorporate multiple frame types, for example, using a combination of nonframed walls with a framed roof/ceiling. Likewise, multiple insulation materials often are used.

**Framed Assemblies**

Framed assemblies include wood and steel construction insulated with batts of mineral fiber, mineral and natural wool, or cellulose; loose-fill insulation of mineral fiber, mineral and natural wool, cellulose, or spray polyurethane foam (SPF). Rigid board insulation may be used on the exterior or interior of framed or nonframed assemblies.

**Nonframed Assemblies** Nonframed assemblies include structural insulated panels (SIP), insulated concrete forms (ICF), and mass walls of masonry, concrete and concrete sandwich panels, log walls, and straw bale.

**Note for Contractors/Installers: Tips for Implementing QII**

Applies to all Insulation	QII applies to the whole building - roof/ceilings, walls, and floors - and requires field verification by a third-party HERS Rater.
Slab Edge Insulation	<ul style="list-style-type: none"> <li>If slab edge insulation is installed, then the integrity of the slab edge insulation must also be field-verified in addition to the air barrier and insulation system for walls and the roof/ceiling.</li> </ul>
Various Insulation Types	<ul style="list-style-type: none"> <li>Combinations of insulation types (hybrid systems) are allowed.</li> </ul>
Air Barriers	<ul style="list-style-type: none"> <li>An air barrier shall be installed for the entire envelope. Air barrier must be verified prior to insulation being installed.</li> </ul>
Additions	<ul style="list-style-type: none"> <li>QII is prescriptively required for additions to existing buildings more than 700 square feet. Refer to Chapter 9 for additional information specific to additions.</li> </ul>
Insulated Headers	<ul style="list-style-type: none"> <li>Headers shall meet one of the following criteria for QII:             <ol style="list-style-type: none"> <li>Two-member header with insulation in between. The header and insulation must fill the wall cavity. There are prefabricated products available that meet this assembly. Example: a 2x4 wall with two 2x nominal headers, or a 2x6 wall with a 4x nominal header and a 2x nominal header. Insulation is required to fill the wall cavity and must be installed between the headers.</li> <li>Two-member header, less than the wall width, with insulation on the interior face. The header and insulation must fill the wall cavity. Example: a 2x6 wall with two 2x nominal headers. Insulation is required to fill the wall cavity and must be installed to the interior face of the wall.</li> <li>Single-member header, less than the wall width, with insulation on the interior face. The header and insulation must fill the wall cavity. Example: a 2x4 wall with a 3-1/8-inch-wide header, or 2x6 wall with a 4x nominal header. Insulation is</li> </ol> </li> </ul>

Applies to all Insulation	QII applies to the whole building - roof/ceilings, walls, and floors - and requires field verification by a third-party HERS Rater.
	<p>required to fill the wall cavity and must be installed to the interior face of the wall. Note: All single member window and door headers shall be insulated to a minimum of R-3 for a 2x4 framing, or equivalent width, and a minimum of R-5 for all other assemblies.</p> <p>d. Single-member header, same width as wall. The header must fill the wall cavity. Example: a 2x4 wall with a 4x nominal header or a 2x6 wall with a 6x nominal header. No additional insulation is required provided that the entire wall has at least R-2 continuous rigid insulation installed on the exterior.</p>
Panel Box Headers	<ul style="list-style-type: none"> <li>• Wood structural panel box headers may also be used as load-bearing headers in exterior wall construction, when built in accordance with California Residential Code (CRC) Figure R602.7.3 and Table R602.7.3.</li> </ul>
Structural Bracing, Tie-Downs, Steel Structural Framing	<ul style="list-style-type: none"> <li>• Metal bracing, tie-downs, or steel structural framing can be used to connect to wood framing for structural or seismic purposes, and comply with QII if:             <ul style="list-style-type: none"> <li>a. Metal bracing, tie-downs, or steel structural framing is identified on the structural plans.</li> <li>b. Insulation is installed in a manner that minimizes the thermal bridging through the structural framing assembly.</li> <li>c. Insulation fills the entire cavity and/or adheres to all six sides and ends of structural assemblies that separate conditioned from unconditioned space.</li> <li>d. The structural portions of assemblies are airtight.</li> </ul> </li> </ul>

Source: California Energy Commission

- **QII in the Compliance Modeling Software.** QII is not a mandatory requirement; therefore, when using the performance approach, QII may be traded off with other efficiency requirements. However, the compliance modeling software assumes QII and full insulation effectiveness in the standard design. The compliance modeling software automatically reduces the effectiveness of insulation for the proposed design in projects that do not pursue QII. The effect of a poorly installed air barrier system and envelope insulation results in higher wall heat loss and heat gain than standard R-value and U-factor calculations would indicate. Similar increases in heat loss and

heat gain are experienced for roof/ceilings where construction and installation flaws are present. The reduction in effectiveness reflects standard industry installation practices and allows for full insulation credit to be taken for HERS verified quality insulation installation.

### **3.5.8.1 Air Barrier RA3.5.2**

An air barrier shall be installed enclosing the entire building. The air barrier must be installed in a continuous manner across all components of framed and nonframed envelope assemblies. The installer shall provide evidence with compliance documentation that the air barrier system meets one or more of the air barrier requirements. More detailed explanation is provided in Reference Appendices, Residential Appendix RA3.5. Documentation for the air barrier includes product data sheets and manufacturer specifications and installation guidelines.

**Note for HERS Raters:** For QII, a third-party HERS Rater is required to verify that the air barrier has been installed properly and is integral with the insulation being used throughout the building.

**Note for Contractors/Installers:** Continuous Air Barrier Requirements

A combination of interconnected materials and assemblies are joined and sealed together to provide a continuous barrier to air leakage through the building envelope separating conditioned from unconditioned space or adjoining conditioned spaces of different occupancies or uses. An air barrier must meet one of the following:

- a. Using materials that have an air permeance not exceeding  $0.004 \text{ cfm/ft}^2$  under a pressure differential of 0.3 in. w.g. (1.57 psf) ( $0.02 \text{ L/s.m}^2$  at 75 pa) when tested in accordance with ASTM E2178.
- b. Using assemblies of materials and components that have an average air leakage not to exceed  $0.04 \text{ cfm/ft}^2$  under a pressure differential of 0.3 in. w.g (1.57 psf) ( $0.2 \text{ L/s.m}^2$  at 75 pa) when tested in accordance with ASTM E2357, ASTM E1677, ASTM E1680 or ASTM E283.
- c. Testing the completed building and demonstrating that the air leakage rate of the building envelope does not exceed  $0.40 \text{ cfm/ft}^2$  at a pressure differential of 0.3 in w.g. (1.57 psf) ( $2.0 \text{ L/s.m}^2$  at 75 pa) in accordance with ASTM E779 or an equivalent approved method.

The following materials meet the air permeance testing performance levels of 1 above. Manufacturers of these and other product types must provide a specification or product data sheet showing compliance to the ASTM testing requirements to be considered as an air barrier.



- Plywood – minimum 3/8 inch
- Oriented strand board – minimum 3/8 inches
- Extruded polystyrene insulation board – minimum 1/2 inch
- Foil-backed polyisocyanurate insulation board – minimum 1/2 inch
- Foil-backed urethane foam insulation – 1 inch
- Closed-cell spray polyurethane foam (ccSPF) with a minimum density of 2.0 pcf and a minimum thickness of 2.0 inches. Alternatively, ccSPF insulation shall be installed at a thickness that meets an air permeance no greater than 0.02 L/s-m<sup>2</sup> at 75 Pa pressure differential when tested in accordance with ASTM E2178 or ASTM E283.
- Open cell spray polyurethane (ocSPF) foam with a minimum density of 0.4 to 1.5 pcf and a minimum thickness of 5½ inches. Alternatively, ocSPF insulation shall be installed at a thickness that meets an air permeance no greater than 0.02 L/s-m<sup>2</sup> at 75 Pa pressure differential when tested in accordance with ASTM E2178 or ASTM E283.
- Exterior or interior gypsum board – minimum 1/2 inch
- Cement board – minimum 1/2 inch
- Built-up roofing membrane
- Modified bituminous roof membrane
- Particleboard – minimum 1/2 inch
- Fully adhered single-ply roof membrane
- Portland cement/sand parge, or gypsum plaster – minimum 5/8 inch
- Cast-in-place and precast concrete
- Fully grouted uninsulated and insulated concrete block masonry
- Sheet steel or aluminum

Materials and assemblies of materials that can demonstrate compliance with the air barrier testing requirements must be installed according to the manufacturer's instructions, and a HERS Rater shall verify the integrity of the installation.

---

### 3.6 Opaque Envelope in the Performance Approach

Some residential projects may not wish to use or do not meet the requirements for prescriptive compliance. The performance approach offers increased flexibility as well as compliance credits for certain assemblies, usually those requiring HERS verification. The designs described below are examples of residential envelope strategies that can be implemented under the performance approach. The proposed design used under the performance approach is compared to the standard design,

which is determined by the prescriptive requirements. Remember that when using the performance approach, all applicable mandatory requirements must still be met.

**Advanced Assemblies.** Common strategies for exceeding the minimum energy performance level set by the 2022 Energy Code include the use of better components such as:

- Higher insulation levels.
- More efficient fenestration.
- Reducing building infiltration.
- Use of cool roof products.
- Better framing techniques (such as the use of raised-heel trusses that accommodate more insulation).
- Reduced thermal bridging across framing members.
- Greater use of nonframed assemblies or panelized systems (such as SIPs and ICFs).
- More efficient heating, cooling, and water-heating equipment.

The performance approach encourages the use of energy-saving techniques for showing compliance with the Energy Code.

**Advanced Building Design.** The design of a building, floor plan, and site design layout all affect energy use. A passive design building uses elements of the building to heat and cool itself, in contrast to relying on mechanical systems to provide the thermal energy needs of the building. Passive solar strategies encompass several advanced high-performance envelope techniques, such as:

1. Carefully choosing the size, type, and placement of fenestration and shading.
2. Providing and controlling fresh air ventilation during the day and night.
3. Having internal and external thermal mass components that help store useful heat and cooling energy.
4. Having highly insulated envelope assemblies.
5. Using high performing roofing materials (cool roofs) and radiant barriers.
6. Having very low air leakage.

Some requirements designed as part of an advanced assembly system may require specific installation procedures or field verification and diagnostic testing to ensure proper performance. Field verification and diagnostic testing are ways to ensure that the energy efficiency features used in compliance calculations are realized as energy benefits to the occupants.

### 3.6.1 Unvented Attics

Attic ventilation is the traditional way of controlling temperature and moisture in an attic. In an unvented attic assembly, insulation is applied directly at the roofline of the building, either above or below the structural roof rafter. The roof system becomes part of the insulated building enclosure. For this case, the thermal boundary of the building results in an unvented attic space between the ceiling gypsum board and the insulated roof above (Figure 3-35).

In addition to meeting the mandatory minimum insulation requirements, the provisions of California Building Code (CBC), Title 24, Part 2.5, Section R806.5 must be met.

**Figure 3-35: Unvented Attic Assembly with Insulation at the Ceiling and Between the Roof Rafters**

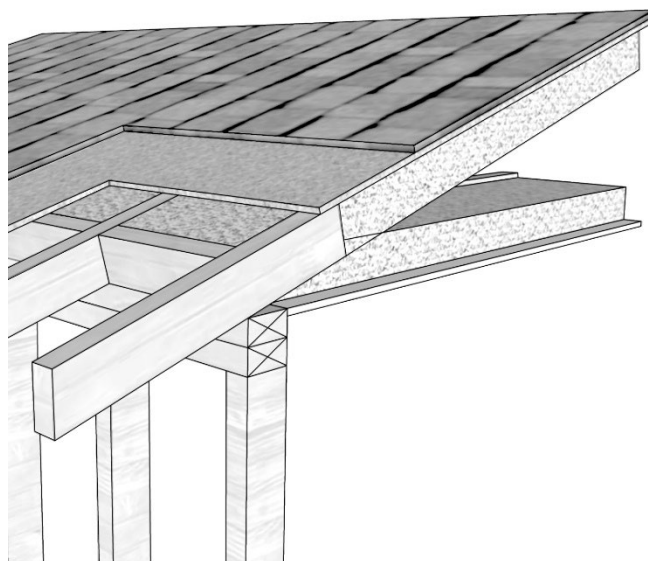

Source: California Energy Commission

Check with the local building jurisdiction to determine its specific requirements for unvented attic conditions.

Combining this strategy with the additional design improvement of low air leakage for the rest of the building would achieve energy savings and compliance energy credit.

Furthermore, this design eliminates the need to seal or limit penetrations at the ceiling level, such as recessed cans, because the air and thermal boundary is now located at the roof deck.

#### 3.6.1.1 Below-Roof Deck Netted Insulation in Unvented Attics

Alternative types of insulation can provide high R-value insulation below the roof deck in an unvented attic. One approach is a boxed netted system that is suspended from the top member of the truss, or top chord, to provide a fill depth that completely encloses the top chord, creating a uniform insulation layer of loose-fill fiberglass across the entire underside of the roof deck. This method can be done with common loose-fill insulation tools and equipment. See Figure 3-36 for details of this type of below-deck netted

insulation. Draped netted insulation, another approach to below-deck insulation, results in a nonuniform insulation layer, created by leaving the truss chords exposed and leading to increased thermal bridging (Figure 3-37).

**Figure 3-36: Box Netted Insulation**

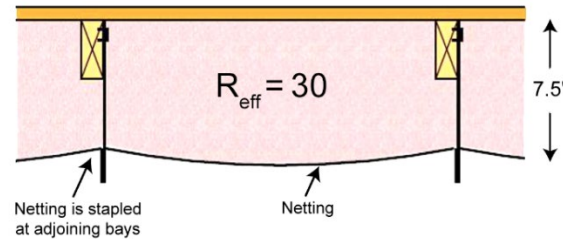

Source: Owens Corning

**Figure 3-37: Draped Netted Insulation**

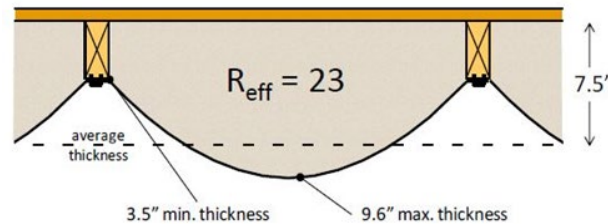

Source: Owens Corning

### Gable Ends in Unvented Attics

In unvented attics, where insulation is applied directly to the underside of the roof deck, framing for gable ends that separate the unvented attic from the exterior or unconditioned space shall be insulated to meet or exceed the wall R-value of the adjacent exterior wall construction. The backside of air-permeable insulation exposed to the unconditioned attic space shall be completely covered with a continuous air barrier.

### 3.6.2 Above-Roof Deck Insulation

A layer of continuous rigid insulation above and in direct contact with the roof deck (sheathing) increases the thermal integrity of the roof system. Continuous above-roof deck insulation is suitable for use with either asphalt shingles or clay/concrete tiles. Required R-values for insulation installed above the roof deck are lower than R-values for insulation installed below the roof deck due to reduced thermal bridging when continuous insulation is applied directly above the roof deck. Further, an air space installed between the roof deck and the roofing tiles or shingles improves cooling of the roof assembly.

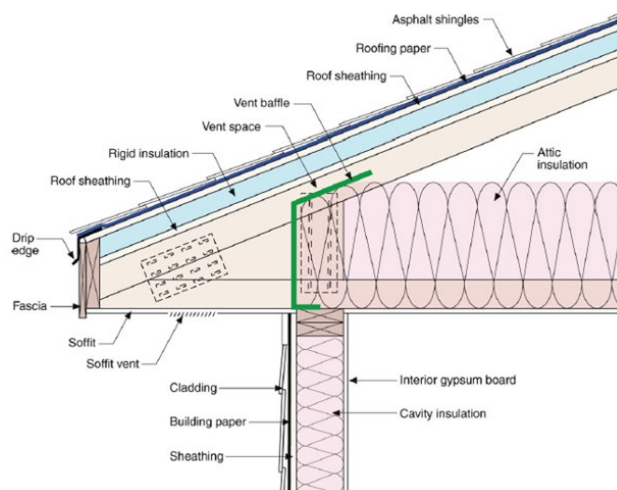
**Figure 3-38: Detail of Above-Roof Deck Insulation**

Source: Building Science Corporation

**Note for HERS Raters:** Check manufacturer's specifications for proper nail schedules (fastening patterns); this will change depending on the roof pitch, truss spacing, and roofing material.

**With concrete and clay tiles.** Standard construction practice in California for concrete and clay tiles is to have an air gap between the tiles and roof deck because the tiles are installed over horizontal battens (or purlins). One option is to install continuous rigid insulation over the roof deck and a second layer of roof sheathing above the rigid insulation. If required by climate zone, a vapor retarder would be installed above the second sheathing layer to host the purlins with the tiles installed over them (Figure 3-39).

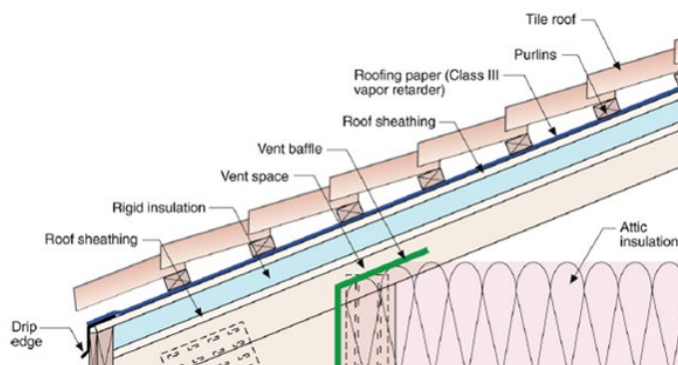
**Figure 3-39: Battens (Purlins) Installed with Above-Roof Deck Insulation**

Source: Building Science Corporation

**With asphalt shingles.** When installing asphalt shingles over above-roof deck insulation, it is best practice to ensure an air gap between the shingles and the top sheathing or insulation, as shown in Figure 3-40, to mitigate the effect of high temperatures that reduce the effective life of roofing products.

**Figure 3--40: Above-Roof Deck Insulation and Air Spaces with and without A Second Layer of Roof Sheathing**

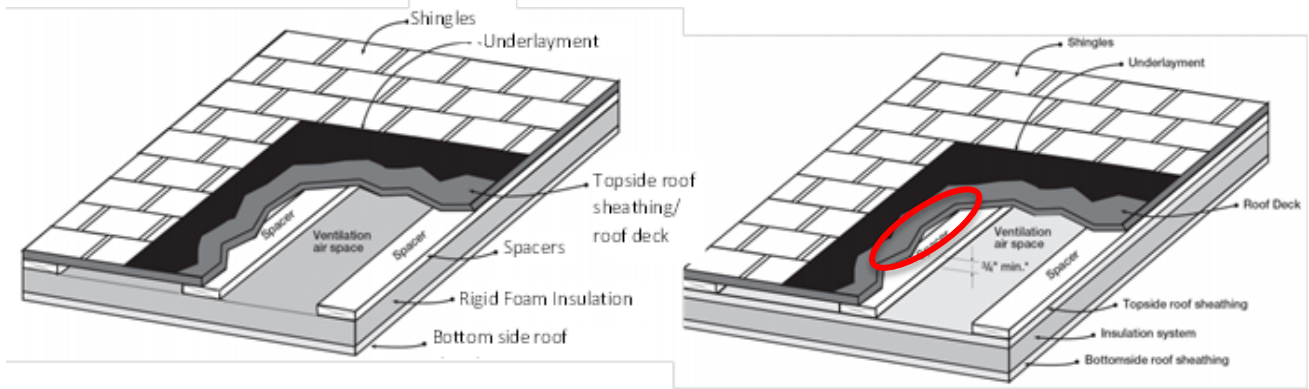

Source: ARMA technical bulletin No. 211-RR-94

Spacers can be inserted above or below a second roof sheathing to provide roof deck ventilation and a nailable base for asphalt shingles (Figure 3-41). Prefabricated insulation products with spacers and top sheathing are available. Check manufacturers’ and trade association websites for a list of products that provide an air space and nailable base.

**Figure 3--41: Asphalt Shingles and Spacers Installed with Above-Roof Deck Insulation**

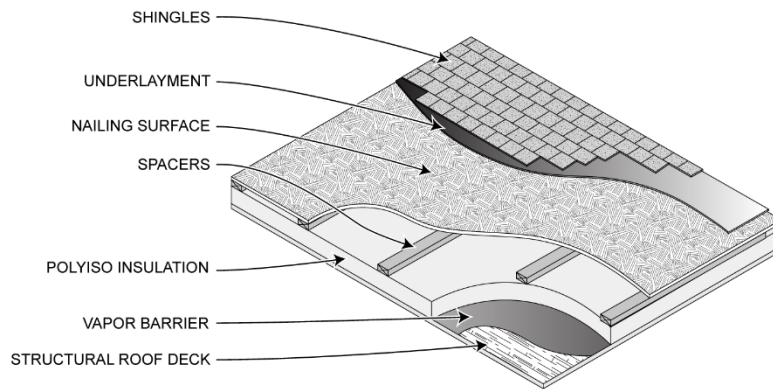

Source: PIMA Tech Bulletin #106

**Example 3-25: Two Layers of Rigid Foam Board Above-Roof Deck**

**Question:** Can two layers of R-4 rigid foam board be installed as an equivalent performance to R8 rigid foam insulation above the roof deck? If so, are there best practices for installing the two layers of insulation?

**Answer:** Yes, installing two R-4 rigid foam board layers is equivalent in performance to R-8. To prevent water infiltration, it is best to stagger the horizontal and vertical joints of the two layers and take care to seal each joint properly.

---

**Example 3--26: Roof Material Directly Over Rigid Insulation**

**Question:** A project plans to install R-6 rigid foam insulation above the roof deck with roofing material placed *directly* over the insulation. What are the best practices for installing the insulation?

**Answer:** Insulation can be installed directly on the roof deck with no air gap, but performance is improved if an air gap is installed between the rigid insulation and the roofing material by using spacers or battens (purlins). Products exist that combine insulation, spacers, and additional sheathing for nailing asphalt shingles. Check with insulation manufacturers for available products.

---

---

**Example 3--27: Fire Ratings Required by CBC, Chapter 15**

**Question:** Does a roof assembly using above-roof deck insulation meet Class A/B/C fire rating specifications, as determined by California Building Code (CBC), Chapter 15?

**Answer:** Application of above-roof deck insulation affects the fire rating classification of roof covering products. Roof covering products are rated to Class A/B/C based on the ASTM E108 (NFPA 256, UL790) test. Class A/B/C ratings are done with specific roof assemblies, and ratings are valid only when the installation is the same as the assembly as rated. Under current building code requirement, tile roof products installed directly over the roof deck or over purlins are automatically rated Class A. Chapter 15 in the California Building Code (and International Building Code Section 1505 for Fire Classification) specify that certain roofing materials are Class A without having to test to ASTM E108. These materials include slate, clay, concrete roof tile, an exposed concrete roof deck, and ferrous and copper shingles; however, asphalt shingles are not covered under this category.

Insulation products, on the other hand, are subject to a different fire test from roof-covering products. The California Building Code and International Building Code (Section 2603 for Foam Plastic Insulation) require foam plastic insulation to be tested to demonstrate a flame-spread index of not more than 75 and a smoke-developed index of not more than 450 according to ASTM E84 (UL723). The requirements apply to roof insulation products, including XPS/polyiso/polyurethane above-deck insulation and SPF below-deck insulation products.

To ensure that insulated roof assemblies meet the proper fire rating classification, roof product manufacturers and insulation manufacturers must test and develop assemblies that meet the CBC testing specifications.

---

**3.6.3 Insulated Roof Tiles**

Insulated roof tile (IRT) is an option for improving the thermal performance of the roof assembly and lowering attic temperatures. IRT combines concrete or clay tiles with insulation as an integrated product (Figure 3-42). These tiles are lighter than typical roof tiles and have better thermal performance than traditional tiles due to the insulating core.

**Figure 3-42: Insulated Concrete Tile**

Source: Green Hybrid Roofing

IRT can reduce radiant losses and maintain warmer roof deck temperatures, thereby reducing the potential for condensation. Using one of the options below provides additional R-value when conventional ceiling insulation is installed.

Configurations A and B in Figure 3-43 can be installed without significant changes to conventional roof or attic design (such as fascia dimensions), and IRT can be used in both vented and unvented attic configurations.

Some IRT products are ASTM-rated for Class A fire rating (ASTM E108) and have CRRC certification for cool roof tiles in multiple colors. It is best practice to check with manufacturers about the U-factor and ASTM ratings for each IRT product. Manufacturers cite several advantages of the product, including the lightweight construction, faster installation than traditional roof tiles, less weight on the roof structure, and improved thermal performance.



Figure 3-43: Insulated Roof Tile (IRT) (A) Attached Directly to Roof Deck, (B) Attached to Batten, (C) Attached Directly to Roof Deck With Wedged Foam Filling Air Space, and (D) Attached to Battens With Wedged Foam Filling Air Space

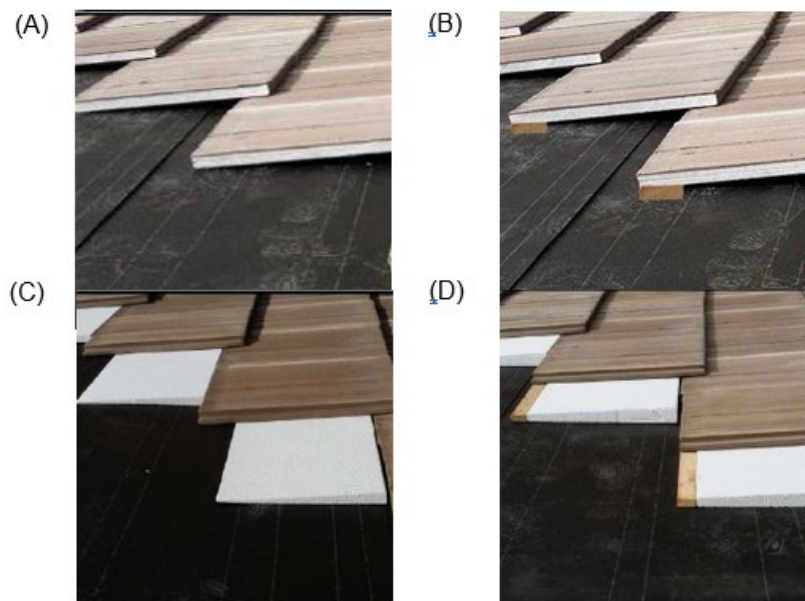

Source: Green Hybrid Roofing

### 3.6.4 Raised Heel, Extension Truss, or Energy Truss

- The use of an energy truss, also referred to as a raised heel or extension truss, allows full depth, uncompressed insulation at the ceiling to continue to the ceiling edge where the roof and ceiling meet. For this strategy, the roof truss is assembled with an additional vertical wood framed section at the point where the top and bottom truss chords meet. The vertical section raises the top chord and provides increased space that can be filled with insulation. See Figure 3-44 for details of a raised heel truss. Benefits of this strategy include:
  - Realizing the full R-value benefit of ceiling insulation.
  - Providing more space for mechanical systems located in the attic.

The 2022 CBECC-Res compliance software allows for the modeling of raised heel trusses and provides credit for the additional edge insulation.

**Note for Contractors/Installers:** Other methods to achieve a similar outcome include framing with rafters on raised top plate, or applying additional spray foam or rigid foam inside the perimeter of the attic.

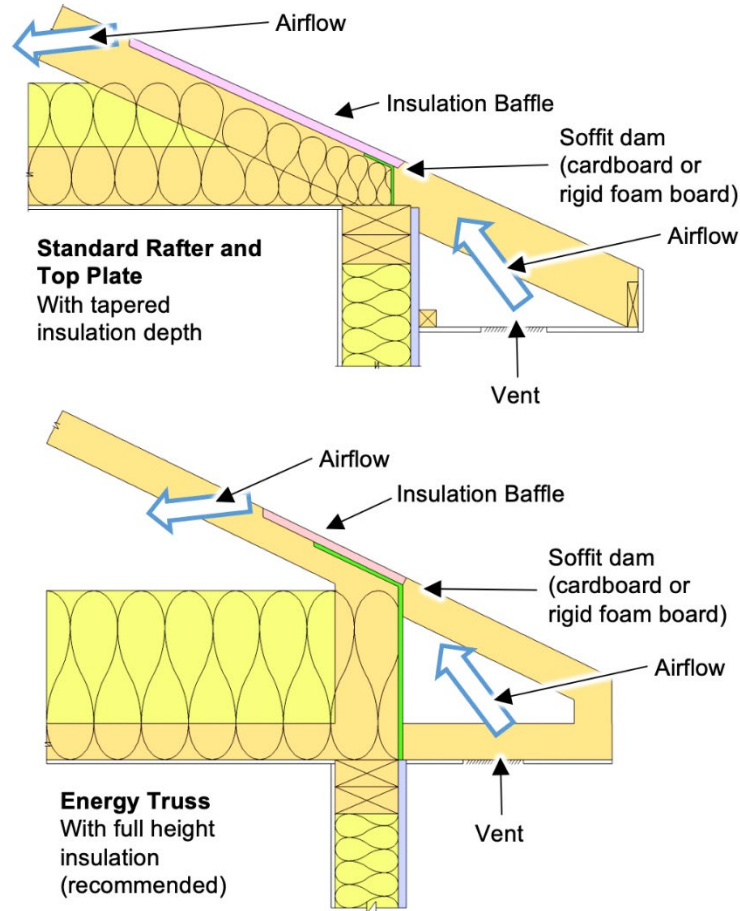
**Figure 3-44: Standard Truss vs. Raised Heel Energy Truss**

Source: California Energy Commission

### 3.6.5 Nail Base Insulation Panel

The nail base insulation panel is an above-roof deck insulation strategy that consists of exterior-facing OSB or other structural sheathing laminated to continuous rigid insulation, which is fastened directly to roof framing (Figure 3-45). This saves the time and expense of installing a structural sheathing layer above and below the rigid insulation. The nail base insulation panel creates a nailing surface for attaching roof cladding.

**Figure 3-45: Nail Base Insulation Panel with Radiant Barrier Affixed to Trusses in a Vented Attic Configuration**

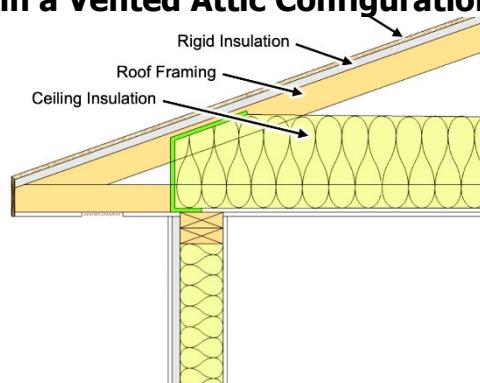

Suitable for vented and unvented attic assemblies, the exposed underside of the rigid insulation is face with a radiant barrier that also provides an ignition/thermal barrier protection as required by code.

Source: California Energy Commission

---

### Example 3-31: Area-Weighted Average Insulation Levels

**Question:** A computer method analysis shows that a new house requires R-19 ceiling insulation to comply using the performance approach, but the minimum mandatory insulation level for ceiling insulation is R-22. Which insulation level should be used?

**Answer:** The mandatory minimum insulation requirement is an area-weighted average U-factor. Some ceiling areas can have lower insulation, such as R-19, but other areas will need to have higher levels of insulation so that the area-weighted average U-factor is at least 0.043.

---



---

### Example 3--28: Minimum Insulation Levels When Using Performance Approach

**Question:** A small addition to an existing house appears to comply using only R-15 ceiling insulation with the performance approach. Does this insulation level comply with the Energy Code?

**Answer:** No. R-15 would not be sufficient because the required minimum ceiling insulation level established by the mandatory requirements is R-22. However, R-15 could be used in limited areas, as follows:

- a. Attic roofs must have a weighted average U-factor of 0.043 or less for the entire ceiling/roof.
  - b. Cathedral or rafter roofs must have a weighted average U-factor of 0.054 or less for the entire ceiling/roof.
- 

### 3.6.6 Advanced Wall Systems and Advanced Framing

Advanced wall systems (AWS), also known as optimum value engineering (OVE) or advanced framing, refer to a set of framing techniques and practices that minimize the amount of wood and labor necessary to build a structurally sound, safe, durable, and

energy-efficient building. AWS improves energy and resource efficiency while reducing first costs.

Reducing the amount of wood in wood-framed exterior walls improves energy efficiency through a reduced framing factor, allowing more insulation to be installed, and has greater resource efficiency for the materials being used. In addition, using fewer framing studs reduces the effects of thermal bridging and increases the amount of insulation in the wall, resulting in a more energy-efficient building envelope. The framing factor assumed for calculating the energy performance of a wood-framed 2x4 wall at 16-inches on center is 25 percent. When AWS is used, the framing factor is reduced to 17 percent, reflecting the improved energy performance of the advanced wall system.

**Figure 3-46: Wood-Framed Wall, 2x6 @ 24" oc, AWF With Three-Stud corners**

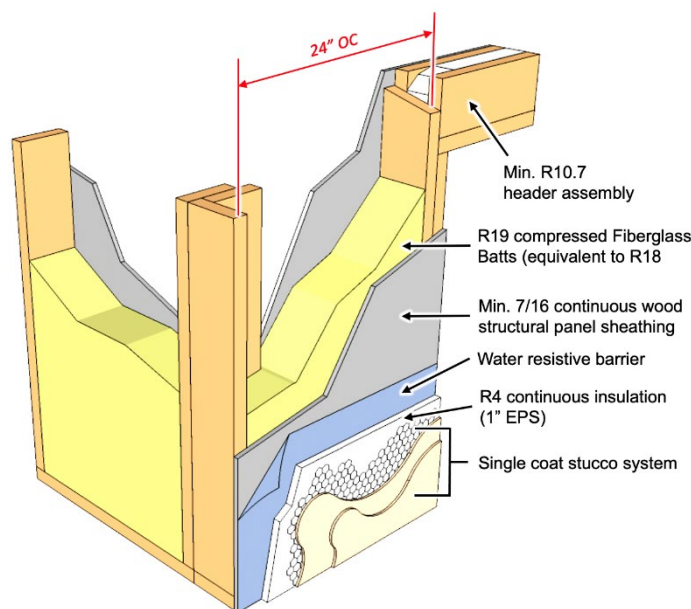

Source: California Energy Commission

**Calculating Assembly U-Factors.** Figure 3-46 depicts one AWS that achieves a U-factor of 0.048 with an exterior insulation of R-4, due to 24" stud spacing and R-13 header assemblies.

Table 3-15 lists the assembly components for the AWS in Figure 3-46.

These values were calculated using the parallel heat flow calculation method, documented in the *2009 ASHRAE Handbook of Fundamentals* and outlined in Reference Appendices, Joint Appendices JA4.1.2 and JA4.6. The construction assembly in Table 4.6.1 in JA4.6 assumes an exterior air film of R-0.17, a 3/8-inch layer of stucco of R-0.08 (SC01), building paper of R-0.06 (BP01), sheathing, or continuous insulation layer, if present, the cavity insulation/framing layer, 1/2-inch gypsum board of R-0.45 (GP01), and an interior air film 0.68. The framing factor is assumed to be 25 percent for 16-inch stud spacing, 22 percent for 24-inch spacing, and 17 percent for advanced wall system (AWS). Actual cavity depth is 3.5 inches for 2x4, 5.5 inches for 2x6.

**Table 3-15: Assembly Components for AWS in Figure 4-46**

Layer	<b>Assembly Type: Wall 2x6 @ 24-inches oc AWS Framing Material: Wood Assembly Components</b>	R-Value Cavity (R <sub>c</sub> )	R-Value Frame (R <sub>f</sub> )	R-Value Header (R <sub>h</sub> )
0	Frame Factor	78%	17%	5%
1	Outside Air Film	0.17	0.17	0.17
2	Building Paper	0.06	0.06	0.06
3	3/8-Inch Single Coat Stucco	0.08	0.08	0.08
4	R4 Continuous Insulation (1" EPS)	4	4	4
5	7/16-Inch Continuous Oriented Strand Board Sheathing (OSB)	0.44	0.44	0.44
6	R-20 Fiberglass Batts	20.0	--	--
7	Header Assembly – 2x Wood			1.485
8	Header Assembly – 2.5 Inches of R4 Foam			10
9	Header Assembly – 2x Wood			1.485
10	2x6 Framing @ R-0.99/Inch	--	5.445	--
11	½-Inch gypsum board	0.45	0.45	0.45
12	Inside Air Film	0.68	0.68	0.68
	Subtotal R-Values	25.88	11.325	18.85
	U-Factors (Frame % x 1/R)	0.0301	0.0150	0.0027
	Assembly U-Factor $(U_{Cavity} + U_{Frame} + U_{Header})$	<b>Assembly U-Factor</b>	<b>0.048</b>	<b>0.048</b>

Source: California Energy commission

**Note for Building Inspectors:** While AWS represents a range of practices, it must be adequately inspected to ensure framing contractors have adhered to all best practice construction techniques throughout the exterior envelope.

Examples of construction practices for AWS that can be used as a general guide for building inspectors:

1. Use a minimum 2x6 at 24-inches on-center wall framing.
2. Use precise engineering of headers on load-bearing walls.
3. Install 2x4, 2x6, or I-joint headers on exterior non-load-bearing walls.

4. Eliminate cripple studs at window and door openings less than 4 feet wide.
5. Align window/door openings with standard stud spacing.
6. The king stud, on at least one side of the window/door opening, must take the place of an on-layout AWS stud.
7. Use an insulated corner, either a two-stud corner or a California (three-stud) corners, as in the examples provided in Figure 3-47.
8. Nailing for interior gypsum board can be accomplished with drywall clips, 1x nailer strip, recycled plastic nailing strip. Drywall clips reduce the potential for drywall cracking.
9. Use ladder block where interior partitions intersect exterior walls, instead of three-stud channels.
10. Eliminate unnecessary double-floor joists underneath nonbearing walls.
11. Use metal let-in T-bracing or other methods on nonshear walls to allow full insulation.
12. Include detailed framing plans and elevations on the construction permit plan set.
13. Optimize house design for efficient material use (for example, reducing header spans, designing exterior surfaces in 2-foot modules, designing clear spans to eliminate interior bearing walls).
14. Build with "insulated headers." An example of a single-ply insulated header is provided in Figure 3-48. See Reference Appendices, Residential Appendix RA3.5 for more information.
15. Use engineered lumber. Examples include "I"-joists, open web floor trusses, 2x raised heel roof trusses, glulam beams, laminated veneer lumber (LVL), laminated strand lumber (LSL), parallel strand lumber (PSL), oriented strand board (OSB).
16. Eliminate trimmers at window and door opening headers less than 4 feet wide, only when rated hangers are used and noted on the plans.
17. Use 2x4 or 2x3 interior nonload-bearing walls.
18. Integrate framing design with HVAC system.
19. Use "inset" shear wall panels.

**Figure 3-47: Advanced Framing Corners**

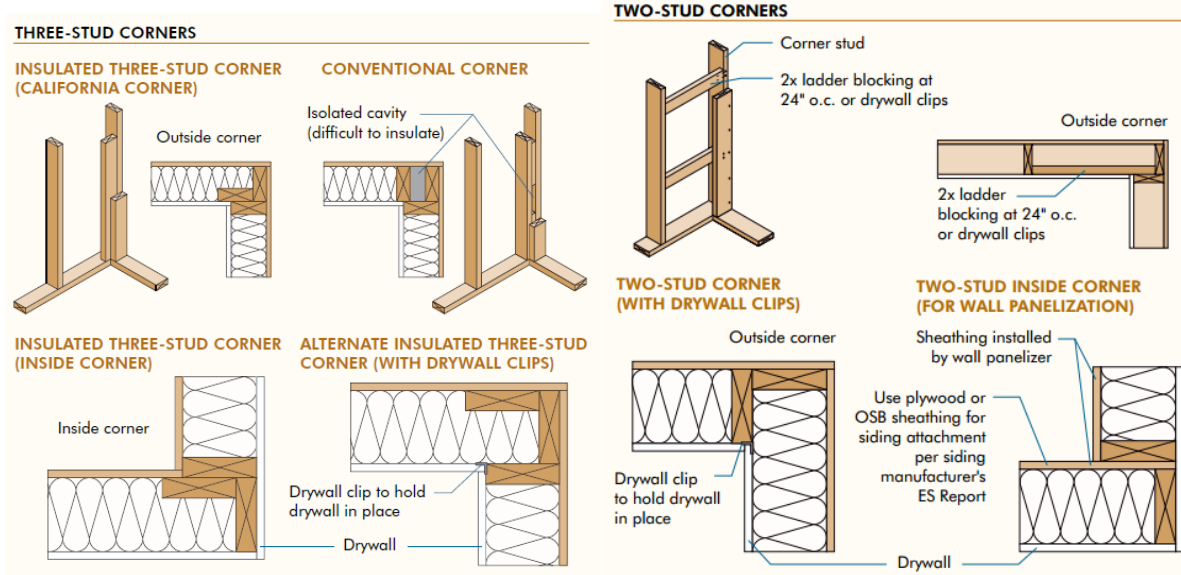

Source: APA Advanced Framing Guide

**Figure 3-48: Headers Designs with Cavity Insulation Space**

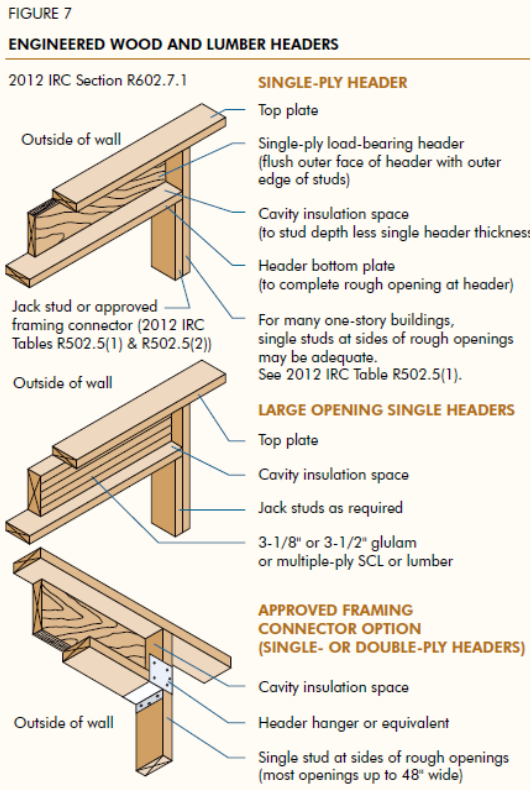

Source: APA Advanced Framing Guide

- Double and Staggered Wall Assemblies.** Double-wall and staggered-wall systems were developed to better accommodate electrical and plumbing systems, allow higher levels of insulation, and provide greater sound reduction. The advantages of these types of wall systems are the following:

1. Smaller dimensional lumber can be used.
2. It is easier to install insulation properly.
3. It eliminates thermal bridging through the framing.
4. It reduces sound transmission through the wall.

With double walls, insulation may be on one side of the wall or on both (higher R-values). It is not uncommon to find double walls with insulation installed within the outside wall cavities, leaving the inside wall sections open for wiring and plumbing (Figure 3-49).

With staggered walls, thermal batt insulation may be installed horizontally or vertically, butting the sides of the insulation until the cavity across the entire wall section is completely filled.

**Figure 349 Double Staggered Wall Assemblies**

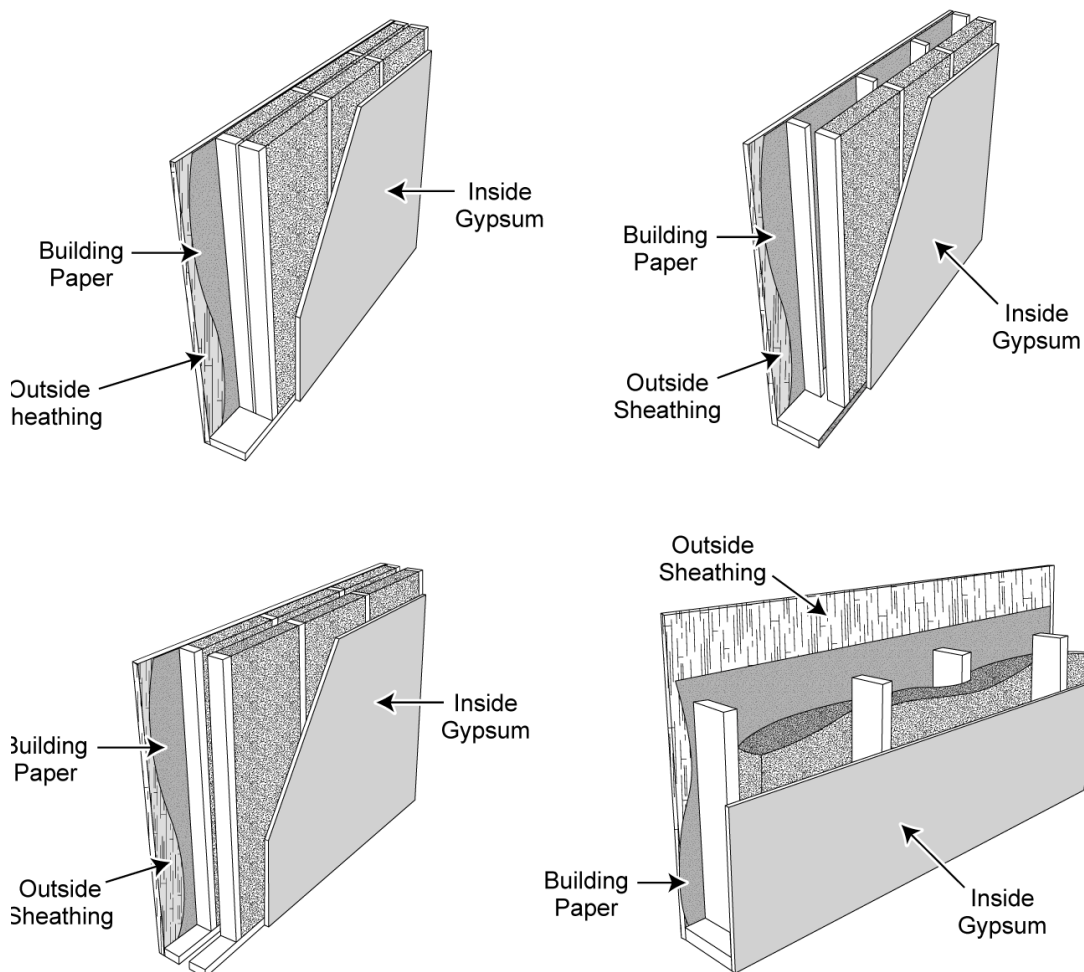

Source: California Statewide CASE Team



### 3.6.7 Metal Framing

A change from wood framing to metal framing can significantly affect compliance. Metal-framed assemblies are often chosen where greater structural integrity is necessary or in climate conditions where greater durability is necessary to protect from the effects of excessive moisture exposure. Metal-framed wall construction generally requires a continuous layer of rigid insulation to meet the mandatory minimum wall insulation levels and the prescriptive requirements since metal is more conductive than wood. In Reference Appendices, Joint Appendix JA4, Table 4.2.4 and Table 4.2.5 have U-factors for metal-framed ceiling/roof constructions. Table 4.3.4 has U-factors for metal-framed walls. Table 4.4.4 and Table 4.4.5 have U-factors for metal-framed floors.

To comply prescriptively, a non-wood-framed assembly, such as a metal-framed assembly, must have an assembly U-factor that is equal to or less than the U-factor of the wood-framed assembly for that climate zone.

### 3.6.8 Structural Foam Wall Systems

The high performance structural foam wall assembly is an advanced assembly system that consists of closed cell spray foam (ccSPF) placed in the cavity bonded to wood framing and continuous rigid board insulation on the exterior of the frame. The bond that occurs between the ccSPF, the framing, and the continuous rigid insulation can provide code-compliant wind and seismic structural load resistance without the use of OSB sheathing (Figure 3-50).

A builder can configure the thicknesses of the cavity ccSPF, rigid insulation, and alternative cavity insulation to attain U-factors of 0.050 or better in 2x4 at 24-inches on center assembly. The structural foam wall assembly can be combined with advanced framing or OVE techniques to increase energy and resource efficiency while reducing material and labor costs.

**Figure 3-50: Example Structural Foam Wall System**

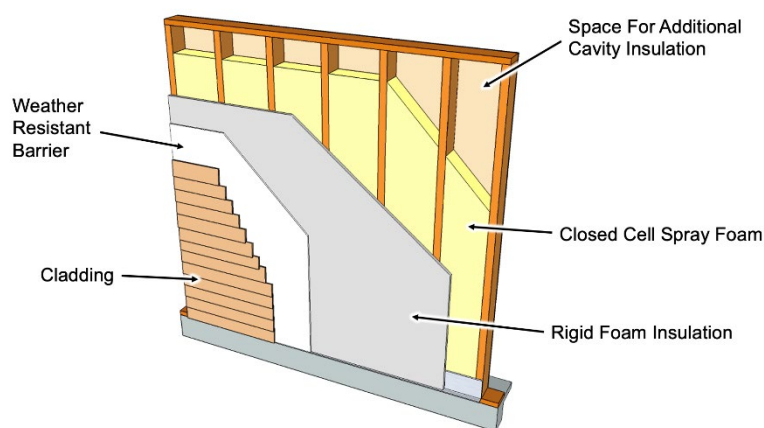

Source: California Energy Commission

**Note for Contractors/Installers:** Structural foam wall systems use ccSPF to insulate, air seal, and structurally bond exterior foam sheathing with wall framing to allow builders to construct 2x4 at 24-inches on center, while improving structural and thermal performance.

### 3.6.9 RESERVED

#### Raised Floor Insulation Requirements

Buildings that have crawl space foundations must meet mandatory requirements for insulation of a raised floor separating the unconditioned crawl space from conditioned space above (§150.0[d]). There also are prescriptive requirements for insulating raised floors in §150.1(c)1C.

An alternative to underfloor insulation is insulating the stem wall of the foundation crawl space. Insulating the crawl space foundation can improve the thermal efficiency of the floor system by:

1. Reducing heat transfer into the unconditioned crawl space.
2. Reducing moisture buildup in the crawl space.
3. Minimizing insulation exposure to adverse weather prior to enclosing the building shell.

**Eligibility Criteria.** The following eligibility criteria in Reference Appendices, Residential Appendix RA4.5.1 are required to be met to use the CVC energy compliance credit:

1. **Ventilation:** All crawl space vents must have automatic vent dampers. Automatic vent dampers must be shown on the building plans and installed. Dampers shall be temperature actuated to be fully closed at about 40°F and fully open at about 70°F. Cross-ventilation consisting of the required vent area shall be distributed between opposing foundation walls.
2. **Insulation:** The R-value of insulation placed on the foundation stem wall shall be equal to or greater than the wall insulation above the raised floor. Stem wall insulation shall run vertically along the stem wall and horizontally across the crawl space floor for a distance of 2 feet (24 inches).
3. **Direct Earth Contact:** Foam plastic insulation used for crawl space insulation having direct earth contact shall be a closed-cell, water-resistant material and meet the slab edge insulation requirements for water absorption and water vapor transmission rate specified in the mandatory requirements (§110.8[g]1).
4. **Vapor Retarder:** A Class I or Class II vapor retarder rated as 1.0 perm or less must be placed over the earthen floor of the crawl space to reduce moisture entry and protect insulation from condensation in accordance with Reference Appendices, Residential Appendix RA4.5.1. This requires essentially a polyethylene-type ground cover having a minimum 6 mil thickness (0.006

inch) or approved equal. The vapor retarder must be overlapped a minimum of 6 inches at joints and shall extend over the top of footings and piers. All overlapping of joints shall be sealed with tape, caulk, or mastic.

- Penetrations, tears, and holes in the vapor barrier shall be sealed with tape, caulk, or mastic.
- Edges of the vapor retarder shall be turned up a minimum of 4 inches at the stem wall and securely fastened and before insulation is installed.
- In sloping crawl space ground soil areas, the vapor retarder shall be securely held in place using fastening methods such as spiked with 5-inch gutter nails, then have proper sealing of penetration holes.
- The vapor retarder shall be shown on the plans.

**Figure 3-51: Controlled Ventilation Crawl Space**

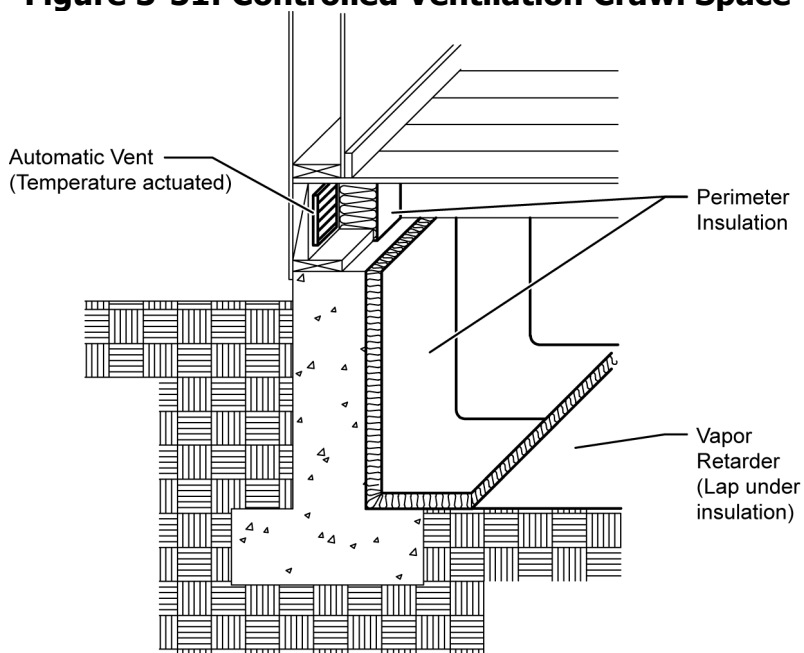

Source: California Energy Commission

**Site Drainage.** Crawl space buildings are susceptible to moisture ponding when good drainage and/or moisture removal designs are not employed. All building designs should ensure that proper site engineering and drainage away from the building is maintained. This includes landscaping techniques that emphasize sound water management strategies.

- **Ground Water and Soils.** Local groundwater tables at maximum winter recharge elevation should be below the lowest excavated elevation of the site foundation. Sites that are well-drained and that do not have surface water problems are generally good candidates for this stem wall insulation strategy. However, allowance for this alternative insulating technique is entirely at the enforcement agency's discretion. The building permit applicant should be prepared to provide

supporting information that site drainage strategies (for example, perimeter drainage techniques) will prevent potential moisture concerns.

### 3.6.10 HERS-Verified Reduced Building Air Leakage RA3.8

A. An energy credit is allowed for single-family buildings through the performance approach when the rate of envelope air leakage of the building is less than the air leakage rate assumed for the standard design building of 5 ACH50.

**Note for HERS Raters:** A third-party HERS Rater shall verify the air leakage rate shown on compliance documentation through diagnostic testing of the air leakage of the building.

**Figure 3-52: Blower Door Testing**



**Blower Door Testing.** The blower door air leakage testing involves closing all the windows and doors; pressurizing the house with a special fan, usually positioned in a doorway (Figure 3-52); and measuring the leakage rate, measured in cubic feet per minute at a 50 Pa pressure difference (CFM50).

The measurement procedure is described in Reference Appendices, Residential Appendix RA3.8 and was derived from the Residential Energy Services Network's (RESNET) Mortgage Industry National Home Energy Rating Standards, Standard 800, which is based on ASTM E779 air-tightness measurement protocols. This procedure requires the use of software consistent with ASTM E779. This test method is intended to produce a measure of the airtightness of a building envelope for determining the energy credit allowance for reduced building air leakage.

**Note for Contractors/Installers:** Tips for Implementing the Reduced Building Air Leakage Compliance Credit

1. This procedure shall be used only to verify the building air leakage rate before the building construction permit is finalized when an energy credit for reduced air leakage is being claimed on compliance documentation.
2. The HERS Rater shall measure the building air leakage rate to ensure measured air leakage is less than or equal to the building air leakage rate stated on the certificate of compliance and all other required compliance documentation. HERS-verified building air leakage shall be documented on compliance forms.
3. This is a whole-building credit; therefore, no credit is allowed for the installation of envelope requirements that may help reduce the air leakage rate of the building, such as for an exterior air retarding wrap or for an air barrier material or assembly meeting the requirements described in Section 3.5.8 under Quality Insulation Installation (QII).

---

## 3.7 Alternative Construction Assemblies

### 3.7.1 Log Homes

Log walls are typically made from trees that have been cut into logs that have not been milled into conventional lumber. Logs used for walls, roofs, and floor systems may be milled or laminated by the manufacturer or supplier to meet specific dimensions and fitting and finishing conditions.

Log homes are an alternative construction type used in some parts of California. Log home companies promote the aesthetic qualities of solid wood construction and can package the logs and deliver them directly to a building site. Some companies provide log wall, roof, and floor systems with special insulating channels or other techniques to minimize the effect of air infiltration between log members and to increase the thermal benefit of the logs.

Log walls do not have framing members like conventional wood stud walls. Section 150.0(c)3 says that opaque nonframed assemblies need to have an overall maximum U-factor of 0.102, which is equivalent to a 2x4 R-13 wood-framed assembly. Per Reference Appendices, Joint Appendix JA4 Table 4.3.11, any log wall 8 inches or more in diameter would meet this requirement, but less than 8 inches would not.

In prescriptive compliance, log walls must meet the same thermal requirements as other construction types. The prescriptive requirements for mass walls are less stringent than the criteria for wood-framed walls. Reduced insulation is allowed because the effects of the thermal mass (interior and exterior) can compensate for less insulation. Footnotes 5 and 6

to Table 150.1-A define the prescriptive mass wall as having heat capacity (HC) 7.0 Btu/°F-ft<sup>2</sup> or more, depending on whether the insulation is interior or exterior.

For performance compliance, consult the compliance software vendor's documentation for any unique modeling requirements for mass walls using values from the Reference Appendices, Joint Appendix.

The thermal performance of log walls is shown in JA4 Table 4.3.11. The U-factor ranges from 0.132 for a 6-inch wall to 0.053 for a 16-inch wall. The U-factor of an 8-inch wall is 0.102, which complies with the mandatory U-factor requirements. U-factors for other log wall constructions (not shown in JA4) would have to be approved by the Energy Commission through the exceptional methods process.

Log walls have a heat capacity that exceeds conventional construction, as seen in JA4 Table 4.3.11 (Thermal Properties of Log Home Walls) (Table 3-16). The thermal mass effects of log home construction can be accounted for within the performance approach.

**Table 3-16: Thermal Properties of Log Home Walls (JA4 Table 4.3.11)**

Left blank	Left blank	U-Factor	Heat Capacity (HC)
Log Diameter	A	A	A
6"	1	0.132	5.19
8"	2	0.102	6.92
10"	3	0.083	8.65
12"	4	0.070	10.37
14"	5	0.060	12.10
16"	6	0.053	13.83

Source: California Energy Commission

**Air Infiltration.** Air infiltration between log walls can be considerably different among manufacturers depending upon the construction technique used. For compliance, infiltration is always assumed to be equivalent to a wood-frame building. The builder should consider using a blower door test to find and seal leaks through the exterior walls.

### 3.7.2 Straw Bale

Straw bale construction is a building method that uses bales of straw (commonly wheat, rice, rye, and oat straw) as structural and insulating elements of the building. Straw bale construction is regulated within the California Building Code (CBC), and specific guidelines are established for moisture content, bale density, seismic bracing, weather protection, and other structural requirements.

The Energy Code has determined specific thermal properties for straw bale walls and thermal mass benefits associated with this type of construction. The performance compliance approach can be used to model the heat capacity characteristics of straw bales.

Straw bales that are 22 inches by 16 inches are assumed to have a thermal resistance of R-30, when stacked so the walls are either 22 inches wide or 16 inches wide. The minimum density of load bearing walls is 7.0 lb/ft<sup>3</sup>, and this value or the actual density may be used for modeling straw bale walls in the performance approach. Specific heat is set to 0.32 Btu/lb-°F. Volumetric heat capacity (used in some computer programs) is calculated as density times specific heat. At a density of 7 lb/ft<sup>3</sup>, for example, the volumetric heat capacity of the straw bale is 2.24, and 6.34 Btu/ft<sup>3</sup>-°F for the entire wall assembly. See Reference Appendices, Joint Appendix JA4 Table 4.3.12

The minimum dimension of the straw bales when placed in the walls must be 22 inches by 16 inches, and there are no restrictions on how the bales are stacked. Due to the higher resistance to heat flow across the grain of the straw, a bale laid on edge with a nominal 16-inch horizontal thickness has the same R-Value (R-30) as a bale laid flat.

The nature of straw bale construction provides an effective air barrier. For compliance, infiltration is assumed to be equivalent to framed walls.

### 3.7.3 Structural Insulated Panels (SIPs)

A. Structural insulated panels (SIPs) are a nonframed advanced construction system that consists of rigid foam insulation sandwiched between two sheets of board. The board can be sheet metal, plywood, cement, or oriented strand board (OSB), and the foam can be expanded polystyrene foam (EPS), extruded polystyrene foam (XPS) or polyurethane (PUR), or polyisocyanurate (ISO) foam. SIPs combine several components of conventional building, such as studs and joists, insulation, vapor barrier, and air barrier. They can be used for many different applications, such as exterior walls, roofs, floors, and foundation systems. Little or no structural framing penetrates the insulation layer. Panels are typically manufactured at a factory and shipped to the job site in assemblies that can be as large as 8 feet by 24 feet.

**Note for Architects/Designers:** SIPs U-Factors for Compliance

In the field, the SIPs panels are joined in one of three ways, as shown in Figure 3-53:

1. Single or double 2x splines
2. I-joists
3. With OSB splines.

The choice of these options affects thermal performance and structural capacity. The 2x and I-joist spline types fit in a recess of the foam core, between the two layers of plywood or OSB. Reference Appendices, Joint Appendix JA4 Table 4.2.3 contains U-factors for roof/ceiling assemblies, JA4 Table 4.3.2 has U-factors for SIPS wall assemblies, and JA4 Table 4.4.3 has U-factors for SIPS floor constructions. U-factors used for compliance must be taken from these tables or by using Commission-approved performance compliance software.

**Figure 3-53: Methods of Joining SIPS Panels**



Source: California Energy Commission

### 3.7.4 Insulating Concrete Forms (ICF)

A. Insulating concrete forms (ICFs) are a system of formwork for concrete that stays in place as permanent building insulation and can be used for cast-in-place reinforced above- and below-grade concrete walls, floors, and roofs. They are interlocking modular units that can be dry-stacked (without mortar) and filled with concrete as a single concrete masonry unit (CMU). ICFs lock together externally and have internal metal or plastic ties to hold the outer layer(s) of insulation to create a concrete form and are manufactured from several materials, including expanded and extruded polystyrene foam, polyurethane foam, cement-bonded wood fiber, and cement-bonded polystyrene beads.

Three factors contribute to the energy efficiency of buildings using an ICF wall:

1. Continuous rigid insulation on both sides of a high-mass core
2. Elimination of thermal bridging from wood framing components
3. A high degree of airtightness inherent to this method of construction.



Climate zones with large daily temperature fluctuations have the greatest potential to benefit from the time lag and temperature dampening effects of these high-mass envelope systems. However, this combination of mass and insulation is beneficial in almost all climates, with the possible exception of mild coastal climate zones.

There are three basic types of ICFs:

1. Flat wall - A flat wall ICF results in a wall with a consistent and continuous thickness of concrete.
2. Waffle-grid - A waffle-grid ICF creates a concrete waffle pattern, an uninterrupted grid, with some concrete sections thicker than others.
3. Screen-grid - A screen-grid ICF consists of a discrete post-and-beam structure with the concrete completely encapsulated by the foam insulation, except at the intersection of posts and beams.

The insulating panels for all three ICF types are most commonly made from expanded polystyrene (EPS) and extruded polystyrene (XPS) rigid insulation boards. Insulating panels also are made from polyurethane (PUR), composites of cement and EPS, and composites of cement and shredded wood fiber, although these tend to be proprietary materials developed by the ICF manufacturer.

Plastic or metal cross-ties, consisting of two flanges and a web, separate the insulating panels and provide structural integrity during the pouring of concrete, resulting in uniform wall thickness. A variety of wall thicknesses can be obtained by changing the length of the web. The area of attachment of the cross-ties to the insulating form provides a secure connection surface located at standard spacing for mechanical attachment of finished materials to the interior and exterior of the wall. ICFs can be used to construct load-bearing and nonload-bearing walls and above- and below-grade walls and can be designed to structurally perform in any seismic zone.

The ICF system is modular and stackable with interlocking edges. The materials can be delivered as preassembled blocks or as planks that require the flanges and web to be assembled during construction. The forms vary in height from 12-inches – 24-inches and are either 4-feet or 8-feet long. Vertical panels come in similar modules but are stacked vertically. ICF panels are typically available with core thickness ranging from 4-inches to 12-inches.

- The thermal aspects of ICFs are represented in Reference Appendices, Joint Appendix JA4 Table 4.3.13.

## Table of Contents

4	Building HVAC Requirements	1
4.1	Overview.....	1
4.1.1	Introduction and Organization .....	1
4.1.2	What’s New for the 2022 Energy Code .....	2
4.1.3	California Appliance Standards and Equipment Certification .....	2
4.2	Heating Equipment .....	4
4.2.1	Mandatory Measures for Heating Equipment.....	4
4.2.2	Prescriptive Requirements for Heating Equipment .....	16
4.2.3	Performance Compliance Options for Heating Equipment .....	16
4.3	Cooling Equipment.....	17
4.3.1	Mandatory Measures for Cooling Equipment .....	17
4.3.2	Prescriptive Requirements for Cooling Equipment .....	27
4.3.3	Performance Compliance Options for Cooling Equipment.....	29
4.4	Air Distribution System Ducts, Plenums, Fans, and Filters.....	31
4.4.1	Mandatory Measures for Air Distribution System Ducts, Plenums, Fans, and Filters	32
4.4.2	Prescriptive Requirements for Air Distribution System Ducts, Plenums, and Fans	60
4.4.3	Compliance Options for Air Distribution System Ducts, Plenums, and Fans .	67
4.4.4	Duct Installation Standards.....	71
4.5	Controls .....	77
4.5.1	Thermostats .....	77
4.5.2	Zonal Control for Compliance Credit.....	78
4.6	Indoor Air Quality and Mechanical Ventilation .....	81
4.6.1	Continuous Mechanical Ventilation for Indoor Air Quality.....	82
4.6.2	Types of Mechanical Ventilation Systems.....	82
4.6.3	Compliance and Enforcement .....	85
4.6.4	Typical Solutions for Single-Family Dwelling Unit Ventilation.....	88
4.6.5	Whole-Dwelling Unit Ventilation Airflow Measurement.....	94
4.6.6	Dwelling Unit Ventilation Rate.....	95

---

4.6.7	Whole-Dwelling Unit Mechanical Ventilation Energy Consumption.....	102
4.6.8	Local Mechanical Exhaust .....	104
4.6.9	Other Requirements (Section 6 of ASHRAE 62.2) .....	109
4.6.10	Air-Moving Equipment (Section 7 of ASHRAE 62.2).....	118
4.7	Alternative Systems.....	125
4.7.1	Hydronic Heating Systems .....	125
4.7.2	Radiant Floor System .....	130
4.7.3	Evaporative Cooling.....	135
4.7.4	Ground-Source Heat Pumps.....	136
4.7.5	Solar Space Heating .....	137
4.7.6	Wood Space Heating .....	137
4.7.7	Gas Appliances.....	140
4.7.8	Evaporatively Cooled Condensers.....	140
4.7.9	Variable Capacity Heat Pump Systems.....	140
4.7.10	Ventilation Cooling .....	142
4.8	Refrigerant Charge .....	152
4.8.1	Refrigerant Charge Verification .....	152
	Note to Homeowner: We're not done yet!	159
4.9	Compliance and Enforcement.....	159
4.9.1	Design-Phase Documentation .....	159
4.9.2	Construction-Phase Documentation .....	161
4.9.3	Field Verification and Diagnostic Testing.....	161

---

## 4 Building HVAC Requirements

---

### 4.1 Overview

#### 4.1.1 Introduction and Organization

This chapter addresses the requirements for heating, ventilating, and air-conditioning (HVAC) systems for newly constructed single-family residential buildings include single family residences, duplexes, townhouses, and triplexes. The requirements are a source of information for the general public, mechanical system designers and installers, energy consultants, Home Energy Rating System (HERS) Raters, and enforcement agency personnel.

Each section in this chapter outlines the mandatory measures and, when applicable, the prescriptive and performance or compliance options as they pertain to residential HVAC systems. If the overall home design does not achieve the minimum prescriptive requirements, the designer can consider using the HVAC performance compliance option that allows for making up the deficiencies. See Chapter 1.6 of the Residential Compliance Manual for a more detailed discussion of the compliance process and options.

Each section of this chapter includes mandatory measures, prescriptive requirements, and performance or compliance options. The chapter is organized under the following sections:

1. **Section 4.2** – Heating Equipment.
2. **Section 4.3** – Cooling Equipment.
3. **Section 4.4** – Air Distribution System Ducts, Plenums, and Fans.
4. **Section 4.5** – Controls.
5. **Section 4.6** – Indoor Air Quality and Mechanical Ventilation.
6. **Section 4.7** – Alternative Systems.
7. **Section 4.8** – Refrigerant Charge.
8. **Section 4.9** – Compliance and Enforcement.

Chapter 9 of the Residential Compliance Manual covers the heating and cooling requirements for additions to existing dwellings and for alterations to existing heating and cooling systems.

Chapter 10 of the Residential Compliance Manual covers the electric ready requirements (new under the 2022 Energy Code) including electric readiness for gas and propane furnaces and domestic hot water heaters.

### 4.1.2 What's New for the 2022 Energy Code

The following is an overview of the new HVAC measures for the *2022 Building Energy Efficiency Standards* (Energy Code), including new compliance options that provide greater flexibility in complying with the Energy Code when using the performance method.

#### 4.1.2.1 Mandatory Features and Devices - §150.0

1. Portions of duct systems located in conditioned space and entire duct systems located in conditioned space can be uninsulated if specific conditions are met, as explained in Section 4.4.1 (§150.0(m)1B).
2. Updated ventilation requirements based on applicable sections of 2019 ASHRAE 62.2 and added clarification language (§150.0(o)).
3. Updated local exhaust requirements for kitchen range hoods which includes capture efficiency ratings (§150.0(o)1G).
4. Filter racks or grilles must use a gasket or sealing to prevent air from bypassing the filter (§150.0(m)12Bv).

#### 4.1.2.2 Prescriptive and Performance Compliance Approaches – §150.1

1. Space heating systems used in prescriptive compliance must be a heat pump for climate zones 3, 4, 13, and 14 (§150.1(c)6).
2. Variable Capacity Heat Pump Compliance Option that was approved in November 2019 is incorporated into the 2022 Energy Code (§150.1(b)3Bii).

### 4.1.3 California Appliance Standards and Equipment Certification

#### §110.0 and §110.1

Most heating and cooling equipment installed in new California homes is regulated by the National Appliance Efficiency Conservation Act (NAECA) and/or the California *Appliance Efficiency Regulations (Title 20)*. Both the federal and state appliance standards apply to the manufacturing and sale of new equipment, whether for newly constructed buildings, additions, or alterations (replacements, or repairs). The *Appliance Efficiency Regulations* are enforced at the point of sale (except central split-system air conditioners and central single package air conditioners, see Table 4-6), while the Energy Code explained in this compliance manual is enforced by local enforcement agencies.

The manufacturer must certify that the equipment complies with the current *Appliance Efficiency Regulations* at the time of manufacture. Appliances covered by the *Appliance Efficiency Regulations* include:

1. Room air conditioners

2. Room air-conditioning heat pumps
3. Central air conditioners with a cooling capacity of less than 135,000 British thermal units per hour (Btu/hr)
4. Central air conditioning heat pumps
5. Gas-fired central furnaces
6. Gas-fired boilers
7. Gas-fired furnaces
8. Gas-fired floor furnaces
9. Gas-fired room heaters
10. Gas-fired duct furnaces
11. Gas-fired unit heaters

The *Appliance Efficiency Regulations* do not require certification for:

1. Electric resistance space heaters.
2. Oil-fired wall furnaces, floor furnaces, and room heaters. (Some are voluntarily listed with certified gas-fired furnaces.)

Equipment that does not meet the federal appliance efficiency standards may not be sold in California. Any equipment covered by the *Appliance Efficiency Regulations* and sold in California must have the date of manufacture permanently displayed in an accessible place on that equipment. This date is frequently included as part of the serial number.

Generally, equipment manufactured before the effective date of a new standard may be sold and installed in California indefinitely as long as the performance approach demonstrates energy compliance of the building using the lower efficiency of the relevant appliances. An exception is central split-system air conditioners and central single package air conditioners *installed* in California. The U.S. Department of Energy (DOE) requires compliance with the minimum efficiencies specified in Table 4-6 at the time of installation.

The compliance and enforcement processes should ensure that all installed HVAC equipment regulated by the *Appliance Efficiency Regulations* is certified by the California Energy Commission.

#### 4.1.3.1 Plan Review (Compliance)

During the plan review, the builder is responsible for demonstrating compliance with the *Appliance Efficiency Regulations* by providing the efficiency of the HVAC equipment that is to be installed. Typically, the builder does not identify the exact make or model at this point of the process. The plans examiner is responsible for verifying that the specified equipment efficiency complies with the *Appliance Efficiency Regulations*.

#### 4.1.3.2 Field Inspection (Enforcement)

It is the field inspector's responsibility to visually verify that the product information on the installed HVAC equipment matches the efficiency approved by the plans examiner. To simplify the inspection, the field inspector may reference the CF2R-MCH-01-H submitted by the builder/installing contractor.

---

## 4.2 Heating Equipment

This section addresses the requirements for heating equipment, including furnaces, boilers, heat pumps, and electric resistance equipment.

### 4.2.1 Mandatory Measures for Heating Equipment

#### 4.2.1.1 Equipment Efficiency

*§110.1 and §110.2(a)*

The efficiency of most heating equipment is regulated by the National Appliance Energy Conservation Act of 1987 (NAECA, the federal appliance standard) and the California Appliance Efficiency Regulations. These regulations are not contained in the Energy Code but are published separately. These regulations are referenced in §110.1. The *Appliance Efficiency Regulations* include definitions for all types of equipment and are regularly updated.

Note: The *Appliance Efficiency Regulations* that are in effect when the building permit is applied for will determine the minimum efficiency of the appliances identified in the compliance documentation.

The energy efficiency of other equipment is regulated by §110.2(a). Also, see the *Nonresidential Compliance Manual* for more information on larger equipment.

#### A. Gas and Oil-Fired Furnaces

The *Appliance Efficiency Regulations* require gas- and oil-fired central furnaces with outputs less than 225,000 Btu/h to be rated according to the associated annual fuel utilization efficiency (AFUE). Gas- and oil-fired central furnaces with outputs greater than or equal to 225,000 Btu/h are rated according to the respective thermal (or steady-state) efficiency. Refer to Table 4-1 for the applicable efficiency requirements.

**Table 4-1: Minimum Efficiency for Gas- and Oil-Fired Central Furnaces**

<b>Appliance</b>	<b>Rated Input (Btu/h)</b>	<b>Minimum Efficiency (%) AFUE</b>	<b>Minimum Efficiency (%) Thermal Efficiency</b>
Weatherized gas central furnaces with single phase electrical supply	< 225,000	81	NA
Non-weatherized gas central furnaces with single phase electrical supply	< 225,000	80	NA
Weatherized oil central furnaces with single phase electrical supply	< 225,000	78	NA
Non-weatherized oil central furnaces with single phase electrical supply	< 225,000	83	NA
Gas central furnaces	≥ 225,000	NA	81
Oil central furnaces	≥ 225,000	NA	82

Source: California Appliance Efficiency Regulations Title-20 - Table E-5 and E-6

Noncentral gas furnaces and space heaters manufactured on or after April 16, 2013, shall be certified to have AFUE values greater than or equal to those listed in Table 4-2.



**Table 4-2: Minimum Heating Efficiency for Non-ducted, Noncentral, Gas-Fired Heating Equipment**

<b>Type</b>	<b>Capacity (Btu/h)</b>	<b>AFUE</b>
Wall Furnace (fan type)	≤ 42,000	75%
Wall Furnace (fan type)	> 42,000	76%
Wall Furnace (gravity type)	≤ 27,000	65%
Wall Furnace (gravity type)	> 27,000 to ≤ 46,000	66%
Wall Furnace (gravity type)	> 46,000	67%
Floor Furnace	≤ 37,000	57%
Floor Furnace	> 37,000	58%
Room Heater	≤20,000	61%
Room Heater	> 20,000 to ≤ 27,000	66%
Room Heater	> 27,000 to ≤ 46,000	67%
Room Heater	> 46,000	68%

Source: California Appliance Efficiency Regulations Title 20 - Table E-2

### **B. Heat Pumps and Electric Heating**

Heat pumps shall be certified to have a HSPF or coefficient of performance (COP) equal to or better than those listed in Table 4-3.

There are no minimum appliance efficiency standards for electric-resistance or electric-radiant heating systems.

### **C. Gas- and Oil-Fired Central Boilers and Electric Boilers**

Gas- and oil-fired central boilers shall be certified to have an AFUE or *Combustion Efficiency* equal to or better than those listed in

Table 4-4.

**Table 4-3: Minimum Heating Efficiency for Heat Pumps**

<b>Equipment Type</b>	<b>Reference</b>	<b>Configuration/Size</b>	<b>Minimum Heating Efficiency</b>
Packaged terminal heat pumps (heating mode)	Table 110.2 E	Newly constructed or newly conditioned buildings or additions	$3.7 - (0.052 \times \text{Cap}^1/1000) = \text{COP}$
Packaged terminal heat pumps (heating mode)	Table 110.2 E	Replacements	$2.9 - (0.026 \times \text{Cap}^1/1000) = \text{COP}$
Single-phase air source heat pumps (NAECA)	Table C-3	< 65,000 Btu/h cooling	Packaged 8.0 HSPF Split 8.2 HSPF
Single-phase air source heat pumps (NAECA)	Table C-3	Space constrained < 65,000 Btu/h cooling capacity	7.4 HSPF
Single-phase air source heat pumps (NAECA)	Table C-3	Small duct, high velocity < 65,000 Btu/h cooling capacity	7.2 HSPF
Three-phase air source heat pumps	Table C-4	Split-system < 65,000 Btu/h	8.2 HSPF
Three-phase air source heat pumps	Table C-4	$\geq 65,000$ and <135,000	3.4 COP
Three-phase air source heat pumps	Table C-4	$\geq 135,000$ and <240,000	3.3 <sup>2</sup> COP 3.4 <sup>3</sup> COP

<b>Equipment Type</b>	<b>Reference</b>	<b>Configuration/Size</b>	<b>Minimum Heating Efficiency</b>
Three-phase air source heat pumps	Table C-4	≥ 240,000 and <760,000	3.2 COP
Water-source heat pumps	Table C-5	≥ 65,000 and < 135,000 Btu/h	4.3 COP
Water-source heat pumps	Table 110.2 B	≥ 135,000 Btu/h, < 240,000 Btu/h	2.9 COP
Single package vertical heat pumps	Table C-6	< 65,000 single-phase	3.0 COP
Single package vertical heat pumps	Table C65	< 65,000 3-Phase	3.3 COP
Single package vertical heat pumps	Table C-6	≥ 65,000 and < 135,000	3.0 COP
Single package vertical heat pumps	Table C-6	≥ 135,000 and < 240,000	3.0 COP

1. Cap = Cooling Capacity of the product in Btu/h. If the unit’s capacity is less than 7,000 Btu/h, use 7,000 Btu/h in the calculation. If the unit’s capacity is greater than 15,000 Btu/h, use 15,000 Btu/h in the calculation.
2. Electric resistance heating or no heating
3. All other types of heating

Source: California Appliance Efficiency Regulation Title 20 and Energy Code Table C-3, C-4, C-5, C-6; Title 24 Table 110.2-B, 110.2-E

**Table 4-4s: Minimum Efficiency for Gas- and Oil-Fired Central Boilers**

<b>Appliance</b>	<b>Rated Input (Btu/h)</b>	<b>Minimum Efficiency (%)</b>	<b>Efficiency Metric</b>
Gas steam boilers with single-phase electrical supply	< 300,000	82 <sup>1</sup>	AFUE
Gas hot water boilers with single-phase electrical supply	< 300,000	84 <sup>1,2</sup>	AFUE
Oil steam boilers with single-phase electrical supply	< 300,000	85	AFUE
Oil hot water boilers with single-phase electrical supply	< 300,000	86 <sup>2</sup>	AFUE
Electric steam residential boilers	< 300,000	NA	NA
Electric hot water residential boilers	< 300,000	NA	NA
All other boilers with single-phase electrical supply	< 300,000	NA	NA

1 No constant burning pilot light design standard.

2 Automatic means for adjusting temperature design standard.

Source: California Appliance Efficiency Regulations Title 20 Table E-3

**Table 4-5: Minimum Efficiency for Gas- and Oil-Fired Central Boilers**

<b>Appliance</b>	<b>Rated Input (Btu/h)</b>	<b>Minimum Thermal Efficiency (%)</b>	<b>Minimum Combustion Efficiency (%)</b>
Steam boilers; gas-fired, except natural draft;	≥ 300,000	79	81
Steam boilers; gas-fired, natural draft	≥ 300,000	79	81
Steam boilers; oil-fired	≥ 300,000	81	82

Source: California Appliance Efficiency Regulations Title 20 Table E-4

#### 4.2.1.2 Heating System Controls

*§150.0(i), §110.2(b), Exceptions to §110.2(b), §110.2(c), Exception to §110.2(c)*

Heating systems must be controlled by a central energy management control system (EMCS) or by a setback thermostat. The setback thermostat must be capable of allowing the occupant to program temperature set points for at least four periods within a 24-hour time span.

The exception to this is gravity gas wall heaters, floor heaters, room heaters, fireplaces, wood stoves, and noncentral electric heaters.

Any heat pump with supplementary electric resistance heating requires controls with two capabilities to limit the electric resistance heating. The first required capability is to set the cut-on and cut-off temperatures for the heat pump and supplementary electric resistance heating at different levels.

For example, if the heat pump begins heating when the inside temperature reaches 68°F, the electric resistance heating may be set to come on if the temperature goes below 65°F if the heat pump alone could not maintain the set point of 68°F. Also, there must be an “off” mode that automatically shuts off the electric resistance when the inside temperature reaches 68°F.

The second control capability must prevent the supplementary electric resistance heater from operating if the heat pump alone can meet the heating load, except during defrost. There is a limited exception to this second function for “smart thermostats” that provide intelligent recovery, staging, ramping, or another control mechanism that prevents the unnecessary operation of supplementary electric resistance heating when the heat pump alone can meet the heating load.

To meet the thermostat requirements, a thermostat for a heat pump must be a “smart thermostat” that minimizes the use of supplementary heating during startup and enables recovery from setbacks.

Note: Room air conditioner heat pumps are not required to comply with the thermostat requirements.

#### 4.2.1.3 Equipment Sizing

*§150.0(h)1 and 2*

The Energy Code does not set limits on the sizing of heating equipment, but does require that heating loads be calculated for new heating systems. Oversized equipment typically operates less efficiently and can create comfort problems due to excessive cycling and improper airflow.

Acceptable load calculation procedures include methods described in the following publications:

1. *The ASHRAE Handbook – Equipment*
2. *The ASHRAE Handbook – Applications*
3. *The ASHRAE Handbook – Fundamentals*
4. *The SMACNA Residential Comfort System Installation Manual*
5. *ACCA Manual J*

The Energy Code requires that the outdoor design conditions for load calculations be selected from Reference Joint Appendix (JA) JA2 and that the indoor design temperature for heating load calculations be 68°F.

The outdoor design temperature must be no lower than the “heating winter median of extremes,” as listed in JA2.

If the actual city location for a project is not included in JA2, or if the data given for a particular city do not match the conditions at the actual site as well as that given for another nearby city, consult the local building department for guidance.

The load calculations must be submitted with the compliance documentation when requested by the building department.

The load calculations may be prepared by 1) a mechanical engineer, 2) the mechanical contractor who is installing the equipment or 3) someone who is qualified to do so in the State of California according to Division 3 of the Business and Professions Code.

The Business and Professions Code does not prohibit an unlicensed person from preparing plans, drawings, or specifications for single-family dwelling units of wood-frame construction not more than two stories and basement in height, or for certain buildings containing no more than four dwelling units of wood-frame construction not more than two stories and basement in height.

#### 4.2.1.4 **Standby Losses and Pilot Lights**

*§110.5 and §110.2(d)*

Fan-type central furnaces may not have a continuously burning pilot light. This requirement does not apply to wall furnaces, floor furnaces, or any gravity-type furnace. Household cooking appliances also must not have a continuously burning pilot light, except for those without an electrical supply voltage connection and in which each pilot consumes less than 150 Btu/h.

Larger gas-fired and oil-fired forced air furnaces with input ratings equal to or greater than 225,000 Btu/h (which is bigger than a typical residential furnace) must also have an intermittent ignition device (IID) and either power venting or a flue damper.

A vent damper is an acceptable alternative to a flue damper for furnaces where combustion air is drawn from the conditioned space. All furnaces with input ratings equal to or greater than 225,000 Btu/h, including electric furnaces, that are not within the conditioned space must have jacket losses not exceeding 0.75 percent of the input rating.

**4.2.1.5 Pipe Insulation**

*§150.0(j)1, §150.0(j)2, §120.3*

The piping for heat pumps and for steam and hydronic heating systems shall meet the insulation requirements provided below in Table 4-5a-f when the insulation is outside conditioned space, it requires protection from damage caused by environmental conditions. The insulation must be rated for outdoor use or covered with a material that can withstand outdoor conditions. Examples of these types of coverings are aluminum, sheet metal, painted canvas, plastic cover, or, if the insulation is cellular foam, a coating that is water-retardant and shields from solar radiation. Moreover, the insulation used for the refrigerant suction line of a heat pump must be Class I or Class II vapor retardant.

**Table 4 5a: Space-Heating and Service Water-Heating Systems Pipe Insulation (thickness in inches)**

**(Steam, Steam Condensate, Refrigerant, Space Heating, Service Hot Water)**

<b>Fluid Oper. Temp. Range (°F)</b>	<b>Insulation Conduct. (Btu·in/h·ft²°F)</b>	<b>Insulation Mean Rating Temp. (°F)</b>	<b>Pipe Dia. (in) &lt; 1</b>	<b>Pipe Dia. (in) 1 to &lt;1.5</b>	<b>Pipe Dia. (in) 1.5 to &lt; 4</b>	<b>Pipe Dia. (in) 4 to &lt; 8</b>	<b>Pipe Dia. (in) 8 ≤</b>
Above 350	0.32-0.34	250	4.5	5.0	5.0	5.0	5.0
251-350	0.29-0.32	200	3.0	4.0	4.5	4.5	4.5
201-250	0.27-0.30	150	2.5	2.5	2.5	3.0	3.0
141-200	0.25-0.29	125	1.5	1.5	2.0	2.0	2.0
105-140	0.22-0.28	100	1.0	1.5	1.5	1.5	1.5

Source: Energy Code Table 120.3-A



**Table 4 5b: Space-Heating and Service Water-Heating Systems Pipe Insulation (R-Value)**  
**(Steam, Steam Condensate, Refrigerant, Space Heating, Service Hot Water)**

Fluid Oper. Temp. Range (°F)	Insulation Conduct. (Btu·in/h·ft <sup>2</sup> °F)	Insulation Mean Rating Temp. (°F)	Pipe Dia. (in) < 1	Pipe Dia. (in) 1 to <1.5	Pipe Dia. (in) 1.5 to < 4	Pipe Dia. (in) 4 to < 8	Pipe Dia. (in) 8 ≤
Above 350	0.32-0.34	250	<u>R 37</u>	<u>R 41</u>	<u>R 37</u>	<u>R 27</u>	<u>R 23</u>
251-350	0.29-0.32	200	<u>R 24</u>	<u>R 34</u>	<u>R 35</u>	<u>R 26</u>	<u>R 22</u>
201-250	0.27-0.30	150	<u>R 21</u>	<u>R 20</u>	<u>R 17.5</u>	<u>R 17</u>	<u>R 14.5</u>
141-200	0.25-0.29	125	<u>R 11.5</u>	<u>R 11</u>	<u>R 14</u>	<u>R 11</u>	<u>R 10</u>
105-140	0.22-0.28	100	<u>R 7.7</u>	<u>R 12.5</u>	<u>R 11</u>	<u>R 9</u>	<u>R 8</u>

Source: Energy Code Table 120.3-A

**Table 4 5c: Residential Space-Cooling Systems Pipe Insulation (thickness in inches)**  
**(Chilled Water, Refrigerant and Brine)**

Fluid Oper. Temp. Range (°F)	Insulation Conduct. (Btu·in/h·ft <sup>2</sup> °F)	Insulation Mean Rating Temp. (°F)	Pipe Dia. (in) < 1	Pipe Dia. (in) 1 to <1.5	Pipe Dia. (in) 1.5 to < 4	Pipe Dia. (in) 4 to < 8	Pipe Dia. (in) 8 ≤
<u>40-60</u>	<u>0.21-0.27</u>	<u>75</u>	0.75	0.75	1.0	1.0	1.0
<u>Below 40</u>	<u>0.20-0.26</u>	<u>50</u>	1.0	1.5	1.5	1.5	1.5

Source: Energy Code Table 120.3-A

**Table 4 5d: Residential Space-Cooling Systems Pipe Insulation (R-Value)  
(Chilled Water, Refrigerant and Brine)**

<b>Fluid Oper. Temp. Range (°F)</b>	<b>Insulation Conduct. (Btu·in/h·ft<sup>2</sup>°F)</b>	<b>Insulation Mean Rating Temp. (°F)</b>	<b>Pipe Dia. (in) &lt; 1</b>	<b>Pipe Dia. (in) 1 to &lt;1.5</b>	<b>Pipe Dia. (in) 1.5 to &lt; 4</b>	<b>Pipe Dia. (in) 4 to &lt; 8</b>	<b>Pipe Dia. (in) 8 ≤</b>
<u>40-60</u>	<u>0.21-0.27</u>	<u>75</u>	R-6	R-5	R-7	R-6	R-5
<u>Below 40</u>	<u>0.20-0.26</u>	<u>50</u>	R-8.5	R-12	R-12	R-10	R-9

Source: Energy Code Table 120.3-A

**Table 4 5e: Nonresidential Space-Cooling Systems Pipe Insulation  
(thickness in inches)  
(Chilled Water, Refrigerant and Brine)**

<b>Fluid Oper. Temp. Range (°F)</b>	<b>Insulation Conduct. (Btu·in/h·ft<sup>2</sup>°F)</b>	<b>Insulation Mean Rating Temp. (°F)</b>	<b>Pipe Dia. (in) &lt; 1</b>	<b>Pipe Dia. (in) 1 to &lt;1.5</b>	<b>Pipe Dia. (in) 1.5 to &lt; 4</b>	<b>Pipe Dia. (in) 4 to &lt; 8</b>	<b>Pipe Dia. (in) 8 ≤</b>
<u>40-60</u>	<u>0.21-0.27</u>	<u>75</u>	0.5	0.5	1.0	1.0	1.0
<u>Below 40</u>	<u>0.20-0.26</u>	<u>50</u>	1.0	1.5	1.5	1.5	1.5

Source: Energy Code Table 120.3-A

**Table 4 5f: Nonresidential Space-Cooling Systems Pipe Insulation (R-Value)  
(Chilled Water, Refrigerant and Brine)**

<b>Fluid Oper. Temp. Range (°F)</b>	<b>Insulation Conduct. (Btu·in/h·ft<sup>2</sup>°F)</b>	<b>Insulation Mean Rating Temp. (°F)</b>	<b>Pipe Dia. (in) &lt; 1</b>	<b>Pipe Dia. (in) 1 to &lt;1.5</b>	<b>Pipe Dia. (in) 1.5 to &lt; 4</b>	<b>Pipe Dia. (in) 4 to &lt; 8</b>	<b>Pipe Dia. (in) 8 ≤</b>
<u>40-60</u>	<u>0.21-0.27</u>	<u>75</u>	R-3	R-3	R-7	R-6	R-5
<u>Below 40</u>	<u>0.20-0.26</u>	<u>50</u>	R-8.5	R-12	R-12	R-10	R-9

Source: Energy Code Table 120.3-A

## 4.2.2 Prescriptive Requirements for Heating Equipment

### §150.1(c)6

Prescriptive component compliance requires the installation of a gas heating system or heat pump, depending on the climate zone, that meets minimum energy efficiency ratings (See Table 4-1 through Table 4-4).

The heating system type must be a heat pump in climate zones 3, 4, 13, and 14. There are no restrictions on the type of heat pump that can be installed if it meets the minimum efficiency rating requirements. For all other climate zones, the heating system can be either a heat pump or a gas heating system.

Supplemental heating systems are allowed prescriptively, and the designer may elect to provide supplemental heating to a space such as a bathroom. In this instance, the supplemental heating system must be installed in a space that is served directly or indirectly by the primary heating system and must have a thermal capacity of less than 2 kilowatts (kW) or 7,000 Btu/h while being controlled by a time-limiting device not exceeding 30 minutes.

Electric resistance and electric radiant heating installations are not allowed as the primary heating system when using the prescriptive compliance approach.

## 4.2.3 Performance Compliance Options for Heating Equipment

### §150.1(b)3

Through the performance compliance approach there is one option for receiving compliance credit related to the heating system.

### 4.2.3.1 High-Efficiency Heating

Heating system efficiencies are explained in Section 4.2.1.1. The minimum efficiency is required to be met for prescriptive compliance or performance compliance. When the performance compliance approach is used, additional compliance credit may be available from higher efficiency heating equipment which can be used to offset less efficient building features.

When a heat pump is providing space heating, if the efficiency used for compliance is higher than the minimum required HSPF, the system efficiency must be verified by a HERS Rater. Moreover, because the capacity of the heat pump affects the amount of back-up electric resistance heating required to attain and maintain comfort conditions, if the capacity proposed for compliance is different than the default capacity used in the performance compliance software, the Air Conditioning, Heating, and Refrigeration Institute (AHRI) ratings for heating capacity of the installed heat pump must be verified by a HERS Rater to confirm the heating capacities at 47 degrees F and 17 degrees F are equal or greater than the heating

capacities given on the certificate of compliance (CF1R). See RA3.4 for more information about this HERS verification

---

## 4.3 Cooling Equipment

This section addresses the requirements for space-cooling equipment.

### 4.3.1 Mandatory Measures for Cooling Equipment

#### 4.3.1.1 Equipment Efficiency

*§110.1 and §110.2(a)*

The efficiency of most cooling equipment is regulated by NAECA (the federal appliance standard) and the California Appliance Efficiency Regulations. These regulations are not contained in the Energy Code but are referenced in §110.1. The energy efficiency of larger equipment is regulated by §110.2(a). See the *Nonresidential Compliance Manual* for information on larger equipment.

#### **A. Central, Single-Phase Air Conditioners and Air Source Heat Pumps (Under 65,000 Btu/h)**

The central, single-phase air conditioners and air source heat pumps that are most commonly installed in homes have a capacity less than 65,000 Btu/h. The *Appliance Efficiency Regulations* for this equipment require minimum seasonal energy efficiency ratios (SEER).

The SEER of all new central, single-phase air conditioners and air source heat pumps with output less than 65,000 Btu/h shall be certified to the Energy Commission to have values no less than the values listed in Table 4-6.

**Table 4-6: Minimum Cooling Efficiencies for Central Air Conditioners and Heat Pumps  
(Cooling Capacity Less Than 65,000 Btu/h)  
(NR = No Requirement)**

<b>Appliance</b>	<b>Type</b>	<b>SEER</b>	<b>EER</b>
Central Air Conditioners	Split-System <45,000 Btu/h	14.0	12.2
Central Air Conditioners	Split-System ≥45,000 Btu/h	14.0	11.7
Central Air Conditioners	Single-Package	14.0	11.0
Central Air Source Heat Pumps	Split-System	14.0	NR
Central Air Source Heat Pumps	Single-Package	14.0	NR
Space-Constrained Air Conditioner	Split-System	12.0	NR
Space-Constrained Air Conditioner	Single-Package	12.0	NR
Space-Constrained Heat Pump	Split-System	12.0	NR
Space-Constrained Heat Pump	Single-Package	12.0	NR
Small-Duct, High-Velocity Air Conditioner	All	12.0	NR
Small-Duct, High-Velocity Heat Pump	All	12.0	NR

Source: California Appliance Efficiency Regulations, Title 20, Table C-3 and Federal Appliance Standards (NAECA)

**B. Other Air Conditioners and Heat Pumps**

*Appliance Efficiency Regulations*

The current *Appliance Efficiency Regulations* for three-phase models, larger-capacity central air conditioners and heat pumps, and all room air conditioners and room air conditioner heat pumps shall be certified to the Energy Commission by

the manufacturer to have values no less than the values listed in Table 4-7 and Table 4-8.

**Table 4-7: Minimum Cooling Efficiency for Three-Phase Models and Larger Capacity Central Air Conditioners and Heat Pumps**

<b>Equipment Type</b>	<b>Size Category (Btu/h)</b>	<b>SEER or EER</b>
Central Air-Conditioners	< 65,000 Split-System	13.0 SEER
Central Air-Conditioners	< 65,000 Single-Packaged	14.0 SEER
Central Air-Conditioners	≥65,000 but <135,000	11.2 <sup>1</sup> EER 11.0 <sup>2</sup> EER
Central Air-Conditioners	≥135,000 but <240,000	11.0 <sup>1</sup> EER 10.8 <sup>2</sup> EER
Central Air-Conditioners	≥240,000 but <760,000	10.0 <sup>1</sup> EER 9.8 <sup>2</sup> EER
Central Air-Source Heat Pumps	< 65,000 Split-System	14.0 SEER
Central Air-Source Heat Pumps	< 65,000 Single-Packaged	14.0 SEER
Central Air-Source Heat Pumps	≥ 65,000 but <135,000	11.0 <sup>1</sup> EER 10.8 <sup>2</sup> EER
Central Air-Source Heat Pumps	≥135,000 but <240,000	10.6 <sup>1</sup> EER 10.4 <sup>2</sup> EER
Central Air-Source Heat Pumps	≥240,000 but <760,000	9.5 <sup>1</sup> EER 9.3 <sup>2</sup> EER
Central Water-Source Heat Pumps	< 17,000	12.2 EER
Central Water-Source Heat Pumps	≥ 17,000 and < 65,000	13.0 EER

<b>Equipment Type</b>	<b>Size Category (Btu/h)</b>	<b>SEER or EER</b>
Central Water-Source Heat Pumps	≥ 65,000 and < 135,000	13.0 EER
Central Water-Source Heat Pumps	≥ 135,000 and < 240,000	12.5 EER
Central Water-Source Heat Pumps	≥ 240,000 and < 760,000	12.4 EER
Water-Cooled Air Conditioners	< 17,000	12.2 EER
Water-Cooled Air Conditioners	≥ 17,000 < 65,000	13.0 EER
Water-Cooled Air Conditioners	≥ 65,000 and < 135,000	12.1 <sup>3</sup> EER
Water-Cooled Air Conditioners	≥ 135,000 and < 240,000	12.5 <sup>3</sup> EER
Water-Cooled Air Conditioners	≥ 240,000 and < 760,000	12.4 <sup>3</sup> EER

\* Three-phase models only

1 Applies to equipment that has electric resistance heat or no heating.

2 Applies to equipment with all other heating-system types that are integrated into the unitary equipment.

3 Deduct 0.2 from the required EER for units with heating sections other than electric resistance heat.

Source: California Appliance Efficiency Regulations Table C-4, C-5

**Table 4-8: Minimum Cooling Efficiency for Noncentral Space-Cooling Equipment**

<b>Equipment Type</b>	<b>Size Category (Input)</b>	<b>Minimum Efficiency</b>
Room Air Conditioners, With Louvered Sides	< 6,000	11.0 EER
Room Air Conditioners, With Louvered Sides	≥ 6,000 and - 7,999	11.0 EER
Room Air Conditioners, With Louvered Sides	≥ 8,000 and -13,999	10.9EER
Room Air Conditioners, With Louvered Sides	≥ 14,000 and - 19,999	10.7 EER
Room Air Conditioners, With Louvered Sides	≥ 20,000 and 27,999	9.4 EER
Room Air Conditioners, With Louvered Sides	≥ 28,000	9.0 EER
Room Air Conditioners, Without Louvered Sides	< 6,000	10.0 EER
Room Air Conditioners, Without Louvered Sides	≥ 6,000 and - 7,999	10.0 EER
Room Air Conditioners, Without Louvered Sides	≥ 8,000 and - 10,999	9.6 EER
Room Air Conditioners, Without Louvered Sides	≥ 11,000 and - 13,999	9.5 EER
Room Air Conditioners, Without Louvered Sides	≥ 14,000 nd - 19,999	9.3 EER
Room Air Conditioners, Without Louvered Sides	≥ 20,000	9.4 EER
Room Air Conditioner Heat Pumps With Louvered Sides	< 20,000	9.8 EER
Room Air Conditioner Heat Pumps With Louvered Sides	≥ 20,000	9.3 EER



<b>Equipment Type</b>	<b>Size Category (Input)</b>	<b>Minimum Efficiency</b>
Room Air Conditioner Heat Pumps Without Louvered Sides	< 14,000	9.3 EER
Room Air Conditioner Heat Pumps Without Louvered Sides	≥ 14,000	8.7 EER
Casement-Only Room Air Conditioner	All Capacities	9.5 EER
Casement-Slider Room Air Conditioner	All Capacities	10.4 EER
Standard Sized PTAC (cooling mode)	All Capacities	14.0 - (0.300 x Cap/1000) = EER
Non-Standard Sized PTAC (cooling mode)	All Capacities	10.9 - (0.213 x Cap/1000) = EER
Standard Sized PTHP (cooling mode)	All Capacities	14.0 - (0.300 x Cap/1000) = EER
Non-Standard Sized PTHP (cooling mode)	All Capacities	10.8 - (0.213 x Cap/1000) = EER
SPVAC (cooling mode)	< 65,000	11.0 EER
SPVAC (cooling mode)	≥ 65,000 and < 135,000	10.0 EER
SPVAC (cooling mode)	≥ 135,000 and < 240,000	10.0 EER
SPVHP (cooling mode)	< 65,000 Btu/h	11.0 EER
SPVHP (cooling mode)	≥ 65,000 and < 135,000	10.0 EER
SPVHP (cooling mode)	≥ 135,000 and < 240,000	10.0 EER

Cap. = Cooling Capacity (Btu/h)

Note: Including room air conditioners and room air conditioner heat pumps, package terminal air conditioners (PTAC), package terminal heat pumps (PTHP), single-package vertical air conditioners (SPVAC), and heat pumps (SPVHP).

Source: California Appliance Efficiency Regulations Title 20, Table B-2, B-3, B-4; Energy Code Title 24, Table 110.2-E

**4.3.1.2 Insulation for Refrigerant Lines in Split-System Air Conditioners**

*§150.0(j)2 and 3, §150.0(m)9*

Two refrigerant lines connect the indoor and outdoor units of split-system air conditioners and heat pumps. These are the liquid line (the smaller diameter tube) and the suction line (the larger diameter tube).

If the liquid line remains at an elevated temperature relative to outdoor and indoor temperatures, it should not be insulated. In this situation, the heat loss is helpful.

The suction line carries refrigerant vapor that is cooler than ambient in the summer and (with heat pumps) warmer than ambient in the winter. This line must be insulated to the required thickness (in inches) as specified in Table 4-9.

**Table 4 9a: Insulation Requirements for Split-System Refrigerant Piping Space heating and Service Water Heating Systems (Steam, Steam Condensate, Refrigerant, Space Heating, Service Hot Water)**

<b>Fluid Operating Temperature Range (°F)</b>	<b>Conductivity (Btu·in/h·ft<sup>2</sup>°F)</b>	<b>Mean Rating Temperature (°F)</b>	<b>Inches normal pipe diameter &lt;1</b>	<b>Inches normal pipe diameter 1 to &lt;1.5</b>
<u>105-140</u>	<u>0.22-0.28</u>	<u>100</u>	1.0 inches <sup>1</sup>	1.5 inches <sup>1</sup>
<u>105-140</u>	<u>0.22-0.28</u>	<u>100</u>	<u>R 7.7</u>	<u>R 12.5</u>

1. These thicknesses are based on energy efficiency considerations only. Issues such as water vapor permeability or surface condensation sometimes require vapor retarders or additional insulation.

Source: Table 120.3-A of the Energy Code

**Table 4 9b: Insulation Requirements for Split-System Refrigerant Piping Space-Cooling Systems (Chilled Water, Refrigerant and Brine)**

<b>Fluid Operating Temperature Range (°F)</b>	<b>Conductivity (Btu·in/h·ft<sup>2</sup>°F)</b>	<b>Mean Rating Temperature (°F)</b>	<b>Inches normal pipe diameter &lt;1</b>	<b>Inches normal pipe diameter 1 to &lt;1.5</b>
<u>Residential</u> <u>40-60</u>	<u>0.21-0.27</u>	<u>75</u>	0.75 inches <sup>1</sup>	0.75 inches <sup>1</sup>
<u>Residential</u> <u>40-60</u>	<u>0.21-0.27</u>	<u>75</u>	R-6	R-5

<b>Fluid Operating Temperature Range (°F)</b>	<b>Conductivity (Btu·in/h·ft<sup>2</sup>·°F)</b>	<b>Mean Rating Temperature (°F)</b>	<b>Inches normal pipe diameter &lt;1</b>	<b>Inches normal pipe diameter 1 to &lt;1.5</b>
<u>Nonresidential</u> <u>40-60</u>	<u>0.21-0.27</u>	<u>75</u>	0.50 inches <sup>1</sup>	0.50 inches <sup>1</sup>
<u>Nonresidential</u> <u>40-60</u>	<u>0.21-0.27</u>	<u>75</u>	R-3	R-3
<u>Below 40</u>	<u>0.20-0.26</u>	<u>50</u>	1.0 inches <sup>1</sup>	1.5 Inches <sup>1</sup>
<u>Below 40</u>	<u>0.20-0.26</u>	<u>50</u>	R-8.5	R-14

1. These thicknesses are based on energy efficiency considerations only. Issues such as water vapor permeability or surface condensation sometimes require vapor retarders or additional insulation.

Source: Table 120.3-A of the Energy Code

Insulation used for refrigerant suction lines located outside a condition space, must include a Class I or Class II vapor retarder. The vapor retarder and insulation must be protected from physical damage, UV deterioration, and moisture with a covering that can be removed for equipment maintenance without destroying the insulation. Insulation is typically protected by aluminum, sheet metal jacket, painted canvas, or plastic cover. Adhesive tape should not be used as insulation protection because removal of the tape will damage the integrity of the original insulation during preventive maintenance.

**Figure 4-1: Refrigerant Line Insulation**



Source: Airex Manufacturing Inc.

#### 4.3.1.3 Outdoor Condensing Units

##### §150.0(h)3

Any obstruction of the airflow through the outdoor unit of an air conditioner or heat pump lowers efficiency. Dryer vents are prime sources for substances that clog outdoor coils and sometimes discharge substances that can cause corrosion. Therefore, condensing units shall not be placed within 5 feet of a dryer vent. This requirement is applicable to new installations and to replacements. Regardless of location, condenser coils should be cleaned regularly in all homes. The manufacturer installation instructions may include requirements for minimum horizontal and vertical distance to surrounding objects that should be met if greater than the minimum distance required by the Energy Code.

**Figure 4-2: Noncompliant Condensing Unit Clearance from Dryer Vents**



Source: California Energy Commission

Liquid line filter driers are components of split system air-conditioners and split system heat pumps that are installed in the refrigerant line to remove moisture and particles, from the refrigerant stream. These contaminants may be introduced in the refrigerant as a result of improper flushing, evacuation, and charging procedures, causing the efficiency and capacity of the air conditioner to be impaired, or damaging components. If required by manufacturer's instructions, liquid line filter driers must be installed. Sometimes, liquid line filter driers are preinstalled by manufacturers within condensing units, which makes it difficult for technicians to access. Because of this difficulty, manufacturers have begun changing this practice by installing liquid line filter driers outside condensers, so that they can be easily serviced by technicians and more easily verified by HERS Raters.

The quality of the filter dryer installation impacts the effectiveness of the liquid line filter dryer, as some liquid line filter driers can be installed without regard to the direction of refrigerant flow. Heat pumps, for example, allow refrigerant flow in both

directions. However, in other air conditioners where refrigerant flow occurs in only one direction, correct orientation of the liquid line filter dryer is important.

#### 4.3.1.4 Equipment Sizing

*§150.0(h)*

Similar to heating equipment, the Energy Code does not set limits on the size of cooling equipment, but does require that cooling loads be calculated for new cooling systems. Avoid oversizing the cooling components since oversizing may adversely affect the efficiency of the system. Ducts must be sized correctly, otherwise the system airflow rate may be restricted, adversely affecting the efficiency of the system and preventing the system from meeting the mandatory minimum airflow rate requirements.

The outdoor design conditions for load calculations must be selected from JA2, Table 2-3, using values no greater than the “1.0 percent cooling dry bulb” and “mean coincident wet bulb” values listed. The indoor design temperature for cooling load calculations must be 75°F. Acceptable load calculation procedures include methods described in:

1. *The ASHRAE Handbook – Equipment*
2. *The ASHRAE Handbook – Applications*
3. *The ASHRAE Handbook – Fundamentals*
4. The SMACNA Residential Comfort System Installation Manual.
5. *ACCA Manual J*

Cooling load calculations must be submitted with compliance documentation when requested by the building department. The load calculations may be prepared by 1) a mechanical engineer, 2) the mechanical contractor who is installing the equipment or 3) someone who is qualified to do so in the State of California according to Division 3 of the Business and Professions Code.

#### 4.3.1.5 Hole for Static Pressure Probe (HSPP) or Permanently Installed Static Pressure Probe (PSPP)

*§150.0(m)13*

Space-conditioning systems that use forced air ducts to cool occupiable space shall have a hole for the placement of a static pressure probe (HSPP) or permanently installed static pressure probe (PSPP) installed downstream from the evaporator coil.

The HSPP or PSPP must be installed in the required location, in accordance with the specifications detailed in Reference Residential Appendix (RA) RA3.3. The HSPP or PSPP is required to promote system airflow measurement when using devices/procedures that depend on supply plenum pressure measurements. The

HSPP or PSPP allows HERS Raters to perform the required diagnostic airflow testing in a nonintrusive manner, by eliminating the necessity for the raters to drill holes in the supply plenum for placement of pressure measurement probes.

The size and placement of the HSPP/PSPP shall be in accordance with RA3.3.1.1 and shall be verified by a HERS Rater. In the event that the HSPP/PSPP cannot be installed as shown in Figure RA3.3-1 because of the configuration of the system or that the location is not accessible, an alternative location may be provided that can accurately measure the average static pressure in the supply plenum. If an alternative location cannot be provided, then the HSPP/PSPP is not required to be installed. The HERS Rater will verify this. Not installing an HSPP/PSPP will limit the airflow measurement method to either a powered flow hood or passive (traditional) flow hood.

When the mandatory measure for minimum system airflow rate is in effect (entirely new systems), there must be a hole in the supply plenum, provided by the installing contractor, for the placement of a static pressure probe (HSPP). Alternatively, a permanently installed static pressure probe (PSPP) must be installed in the same location.

This requirement also applies when the plenum pressure matching method or the flow grid method of airflow measurement is used by either the installer or the rater to verify airflow in an altered system. The HSPP/PSPP must be installed by the installer, not the rater.

See Air Distribution Ducts, Plenums, and Fans Section 4.4 for discussion regarding mandatory sizing/airflow requirements for ducted systems with cooling.

### 4.3.2 Prescriptive Requirements for Cooling Equipment

§150.1(c)7

Prescriptive compliance does not require that a cooling system be installed. However, if one is to be installed, the cooling equipment efficiency requirements are specified by the mandatory measures (See Section 4.3.1 above)

Prescriptive requirements for air-cooled air conditioners and air-source heat pumps installed in Climate Zones 2 and 8 through 15 necessitates the installation of a measurement access hole (MAH), refrigerant charge verification (RCV), and minimum system airflow verification. The minimum system airflow installation and RCV must be performed by the installer and/or HERS Rater. The MAH provides a nonintrusive means of measuring return air temperature, which is a parameter important to the RCV process. The alternative to RCV by a HERS Rater is the installation of a refrigerant fault indicator display. When installing a fault indicator display, the installer must still perform a RCV.

Note: The refrigerant charge verification is discussed below (4.3.2.3) and in greater detail later in Section 4.8.

#### 4.3.2.1 Measurement Access Hole (MAH)

The MAH provides a nonintrusive means for refrigerant charge verification by HERS Raters and other third-party inspectors. They eliminate the need for raters/inspectors to drill holes into the installed air conditioning equipment enclosures for placement of the temperature sensors required by the refrigerant charge verification test procedures described in RA3.2.

Installation of MAH must be performed by the installer of the air conditioner or heat pump equipment according to the specifications given in RA3.2.

The MAH feature consists of one 5/8-inch (16 millimeters [mm]) diameter hole in the return plenum, upstream from the evaporator coil. (See Figure RA3.2-1)

#### 4.3.2.2 Minimum System Airflow

Ducted forced air cooling systems must comply with the minimum system airflow rate of greater than or equal to 350 CFM per ton, or 250 CFM/ton for small duct, high velocity systems, when performing the refrigerant charge verification. The airflow is important when performing the refrigerant charge verification to validate the measured values for pressure and temperature. The correct airflow will also improve the performance of the air-conditioning equipment.

The airflow verification procedure is documented in RA3.3.

#### 4.3.2.3 Refrigerant Charge Verification (RCV)

The prescriptive standards for Climate Zones 2 and 8-15 require that a HERS rater verify that ducted air-cooled air conditioners, ducted air-source heat pumps, small-duct high-velocity systems; and mini-split systems have the correct refrigerant charge. The RCV procedures are documented in RA1.2, RA2.4.4, and RA3.2.

*Refrigerant charge* refers to the actual amount of refrigerant present in the system. Excessive refrigerant charge (overcharge) reduces system efficiency and can lead to premature compressor failure. Insufficient refrigerant charge (undercharge) also reduces system efficiency and can cause compressors to overheat. Ensuring correct refrigerant charge can significantly improve the performance of air-conditioning equipment. *Refrigerants* are the working fluids in air-conditioning and heat-pump systems that absorb heat energy from one area (through the evaporator), transfer, and reject it to another (through the condenser).

#### 4.3.2.4 Fault Indicator Display

The installation of a fault indicator display (FID) may be used as an alternative to the prescriptive requirement for HERS diagnostic testing of the refrigerant charge in air conditioners and heat pumps. The installation of an FID does not preclude the

HVAC installer from having to properly charge the system with refrigerant. The FID provides real-time information to the building occupant about the status of the system refrigerant charge, metering device, and system airflow. The FID will monitor and determine the operating performance of air conditioners and heat pumps and provide visual indication to the system owner or operator if the refrigerant charge, airflow, or metering device performance of the system does not conform to approved target parameters for minimally efficient operation. Thus, if the FID signals the owner/occupant that the system requires service or repair, the occupant can immediately call for a service technician to make the necessary adjustments or repairs. An FID can provide significant benefit to the owner/occupant by alerting the owner/occupant to the presence of inefficient operation that could result in excessive energy use/costs over an extended period. An FID can also indicate system performance faults that could result in system component damage or failure if not corrected, thus helping the owner/occupant avoid unnecessary repair costs.

Fault indicator display technologies are expected to be installed at the factory; otherwise, they may be installed in the field according to manufacturer's specifications. JA6 contains more information about FID technologies.

The presence of an FID on a system must be field-verified by a HERS Rater. See RA3.4.2 for the HERS verification procedure, which consists of a visual verification of the presence of the installed FID technology. The rater must inspect to see that the visual indication display component of the installed FID technology is mounted adjacent to the thermostat of the split system. When the outdoor temperature is greater than 55°F, the rater must also observe that the system reports no system faults when the system is operated continuously for at least 15 minutes when the indoor air temperature returning to the air conditioner is at or above 70°F. When the outdoor temperature is below 55°F, the rater must observe that the FID performs a self-diagnosis and indicates that the sensors and internal processes are operating properly.

### **4.3.3 Performance Compliance Options for Cooling Equipment**

There are several options for receiving compliance credit related to the cooling system. These credits are available through the performance compliance method.

#### **4.3.3.1 High-Efficiency Air Conditioner**

Air conditioner efficiencies are determined according to federal test procedures. The efficiencies are reported in terms of seasonal energy efficiency ratio (SEER) and energy efficiency ratio (EER). Savings can be achieved by choosing an air conditioner that exceeds the minimum efficiency requirements.

The EER is the full-load efficiency at specific operating conditions. It is possible that two units with the same SEER can have different EERs. In cooling climate zones of



California, for two units with a given SEER, the unit with the higher EER is more effective in saving energy. Using the performance compliance method, credit is available for specifying an air conditioner with an EER greater than the minimum (Table 4-6). When credit is taken for a high EER and/or SEER, field verification by a HERS Rater is required. (See RA3.4.4).

#### 4.3.3.2 Air Handler Fan Efficacy and System Airflow

It is mandatory that central forced-air systems operate at fan efficacy values less than or equal to

- 0.58 watts/CFM for air handlers that are not gas furnaces.
- 0.45 watts/CFM for gas furnaces.
- 0.62 watts/CFM for small-duct high-velocity system air handlers.

These central forced-air systems also must operate at airflow rates of at least 350 CFM per nominal cooling ton, or 250 CFM/ton for small-duct high-velocity systems. Performance compliance credits are available for demonstrating the installation of a high-efficiency system with a lower fan wattage and/or higher airflow than the mandatory requirements. Compliance with these credits can be achieved by installing a well-designed duct system and can be assisted by a high-efficiency fan. There are two possible performance compliance credits:

1. The performance compliance method allows the user's proposed fan efficacy to be entered and credit earned if it is lower than the default mandatory values. To obtain this credit for a system with cooling, the system airflow must meet the mandatory requirement of at least 350 CFM/ton of nominal cooling capacity.
2. The performance compliance method allows the user's proposed system airflow to be entered and credit earned if it is higher than the default of 350 CFM/ton of nominal cooling capacity. To obtain this credit, the fan efficacy must meet the mandatory requirements listed above.

#### 4.3.3.3 Whole-House Fan Ventilation Cooling

A whole-house fan (WHF) is not a mandatory requirement. It is required in some climate zones when using prescriptive compliance. The three performance compliance options are the following:

1. No WHF is assumed in the performance compliance software (no ventilation cooling). This will be either energy-neutral, or there will be an energy penalty if the applicable climate zone assumes the effects of a WHF.
2. A default WHF means this proposed feature is equivalent to the standard feature used to establish the energy budget of the building (The performance of the fan

is derated to account for deficiencies from installing undersized or inefficiently designed WHF).

3. The HERS-verified WHF option allows for modeling the effects of the WHF without derating the system performance. The HERS-verified option also allows modeling a WHF with a higher airflow rate or lower fan efficacy than the default, which improves the compliance credit.

#### 4.3.3.4 Central Fan Ventilation Cooling

Central fan ventilation cooling (CFVC) performs a function similar to a WHF using the central space-conditioning ducts to distribute outside air. When using the performance compliance approach, a CFVC system may be selected in the compliance software instead of a conventional whole-house fan. Three compliance options are:

1. No CFVC is assumed in the performance compliance software (no ventilation cooling). This will be either energy-neutral, or an energy penalty will be assessed if the applicable climate zone assumes the effects of a WHF.
2. A default CFVC system means the proposed system is equivalent in size and features to a derated WHF.
3. The HERS verified CFVC system option allows for the effects of the system without derating system performance. It also allows for modeling a system with greater capacity, a higher airflow rate or lower fan efficacy than default.

After installation, the contractor must test the actual fan power and airflow of the system using the procedure in RA3.3 and show that it is equal or better than what was proposed in the compliance software analysis.

Field verification by a HERS Rater is required. (See RA3.3.)

---

## 4.4 Air Distribution System Ducts, Plenums, Fans, and Filters

Air distribution system performance can have a big effect on overall HVAC system efficiency. Therefore, air distribution systems are required to meet several mandatory and prescriptive requirements as discussed below.

The 2022 Energy Code specifies mandatory requirements for air distribution ducts to be sealed and tested in all climate zones. There are also several compliance credits available related to duct system design.

Duct efficiency is affected by the following parameters:

1. Duct location (e.g., attic, crawlspace, basement, inside conditioned space, etc.).

2. Specific conditions in the unconditioned space, for example, presence of a radiant barrier.
3. Duct insulation characteristics.
4. Duct internal surface area.
5. Air leakage of the duct system.

In performance calculations, duct efficiency can be calculated in one of two ways:

1. Default input assumptions.
2. Diagnostic measurement values.

The computer program will use default assumptions for the proposed design when the user does not intend to make improvements in duct efficiency.

#### **4.4.1 Mandatory Measures for Air Distribution System Ducts, Plenums, Fans, and Filters**

##### **4.4.1.1 Minimum Insulation**

*§150.0(m)1B*

Space conditioning supply-air and return-air ducts and plenums are required to have a minimum duct insulation level of R-6, except for when the duct or plenum is located in conditioned space as described below. For duct systems located in both unconditioned and conditioned space, the portions of the duct system located in conditioned space are not required to be insulated if all of the following conditions are met and visually confirmed by the building inspector:

1. The non-insulated portion of the duct system is located below the ceiling that separates the occupiable space from the attic and is entirely inside the building's thermal envelope.
2. At all locations where the non-insulated portions of the duct system penetrate into unconditioned space, the penetration must be draft stopped in compliance with California Fire Code Sections 703.1 and 704.1. The penetration must also be air-sealed to the construction materials that are penetrated using materials compliant with California Mechanical Code Section E502.4.2 to prevent air infiltration into the building cavity. Any connections in the unconditioned space must be insulated to a minimum R-6.

CFC sections 703.1 and 704.1 require that materials and firestop systems used through penetrations in fire-resistance-rated construction, construction installed to resist the passage of smoke, and materials and systems used to protect joints and voids in the following locations must be maintained.

- Joints in or between fire-resistance-rated walls, floors or floor/ceiling assemblies and roof or roof/ceiling assemblies.
- Joints in smoke barriers.
- Voids at the intersection of a horizontal floor assembly and an exterior curtain wall.
- Voids at the intersection of a horizontal smoke barrier and an exterior curtain wall.
- Voids at the intersection of a nonfire-resistance-rated floor assembly and an exterior curtain wall.
- Voids at the intersection of a vertical fire barrier and an exterior curtain wall.
- Voids at the intersection of a vertical fire barrier and a nonfire-resistance-rated roof assembly.

The materials and systems must be securely attached to or bonded to the construction being penetrated or the adjacent construction, with no openings visible through or into the cavity of the construction.

CMC E502.4.2 requires that all joints, seams, and penetrations of duct systems must be made airtight by means of mastics, gasketing, or other means.

For duct systems located entirely in conditioned space, the ducts do not require insulation. To determine whether ducts are entirely in conditioned space as defined in §100.1, a rater must field verify by visual inspection and by using the protocols of RA 3.1.4.3.8.

RA 3.1.4.3.8 describes the duct leakage to outside test that determines whether the ducts are within the pressure boundary of the space being served by the duct system. Also, a basic visual inspection of the ducts is required to ensure that no portion of the duct system is obviously outside the apparent pressure/thermal boundary.

Leakage to “outside” means conditioned air leaking from the ducts to anywhere outside the pressure boundary of the dwelling unit conditioned space served by the duct system, which includes leakage to outside the building, and leakage to adjacent dwelling units.

Exception to §150.0(m)1: Ducts and fans integral to a wood heater or fireplace are exempt from §150.0(m)1.

*§150.0(m)5*

For determining the installed R-value of duct insulation based on thickness, when not an integral part of a manufacturer-labeled, insulated duct product such as vinyl flex duct, the following shall be used:

1. For duct wrap, the installed thickness of insulation must be assumed to be 75 percent of the nominal thickness due to compression.
2. For duct board, duct liner, and factory-made rigid ducts not normally subjected to compression, the nominal insulation thickness shall be used.

#### 4.4.1.2 Connections and Closures

*§150.0(m)1 - §150.0(m)3*

The Energy Code sets a number of mandatory measures related to duct connections and closures. These measures address the materials and methods used for duct sealing. The following is a summary. Refer to the sections of the sections listed above for details.

#### 4.4.1.3 Factory-Fabricated Duct Systems

Factory-fabricated duct systems must comply with the following requirements:

1. All factory-fabricated duct systems must comply with UL 181 for ducts and closure systems, including collars, connections, and splices, and be labeled as complying with UL 181.
2. All pressure-sensitive tapes, heat-activated tapes, and mastics used in the manufacture of rigid fiberglass ducts must comply with UL 181 and UL 181A.
3. All pressure-sensitive tapes and mastics used with flexible ducts must comply with UL 181 and UL 181B.
4. Joints and seams of duct systems and related components cannot be sealed with cloth-backed rubber adhesive duct tapes unless such tape is used in combination with mastic and draw bands, or
5. It has on its backing the phrase "CEC approved," a drawing of a fitting to plenum joint in a red circle with a slash through it (the international symbol of prohibition), and a statement that it cannot be used to seal fittings to plenums and junction box joints.

#### 4.4.1.4 Field-Fabricated Duct Systems

Field-fabricated duct systems must comply with the following requirements:

1. Factory-made rigid fiberglass and flexible ducts for field-fabricated duct systems must comply with UL 181. All pressure-sensitive tapes, mastics, aerosol sealants, or other closure systems used for installing field-fabricated duct systems shall meet the applicable requirements of UL 181, UL 181A, and UL 181B.
2. Mastic sealants and mesh:

- a. Sealants must comply with the applicable requirements of UL 181, UL 181A, and/or UL 181B and be nontoxic and water-resistant.
  - b. Sealants for interior applications must be tested in accordance with ASTM C731 and D2202.
  - c. Sealants for exterior applications must be tested in accordance with ASTM C731, C732, and D 2202.
  - d. Sealants and meshes must be rated for exterior use.
3. Pressure-sensitive tapes must comply with the applicable requirements of UL 181, UL 181A, and UL 181B.
  4. Joints and seams of duct systems and their components must not be sealed with cloth-backed rubber adhesive duct tapes unless such tape is used in combination with mastic and draw bands, or
  5. It has on its backing the phrase "CEC approved," a drawing of a fitting to plenum joint in a red circle with a slash through it (the international symbol of prohibition), and a statement that it cannot be used to seal fittings to plenums or junction box joints.

#### 4.4.1.5 **Draw Bands Used With Flexible Duct**

1. Draw bands must be either stainless-steel worm-drive hose clamps or UV-resistant nylon duct ties.
2. Draw bands must have a minimum tensile strength rating of 150 pounds.
3. Draw bands must be tightened as recommended by the manufacturer with an adjustable tensioning tool.

#### 4.4.1.6 **Aerosol-Sealant Closures**

1. Aerosol sealants shall meet the requirements of UL 723 and be applied according to manufacturer specifications.
2. Tapes or mastics used in combination with aerosol sealing shall meet the requirements of this section.

If mastic or tape is used to seal openings greater than 1/4 inch, the combination of mastic and either mesh or tape must be used.

Building spaces such as cavities between walls, support platforms for air handlers, and plenums defined or constructed with materials other than sealed sheet metal, duct board, or flexible duct must not be used for conveying conditioned air, including return air and supply air. Using drywall materials as the interior surface of a return plenum is not allowed. Building cavities and support platforms may contain ducts. Ducts installed in cavities and support platforms must not be compressed to

cause reductions in the cross-sectional area of the ducts. Although a HERS Rater may examine this as a part of his or her responsibilities when involved in a project, the enforcement of these minimum standards for ducts is the responsibility of the building official.

*§150.0(m)2D, §150.0(m)3D*

Duct systems may not use cloth-backed, rubber-adhesive duct tape (typical, “old fashioned,” nonrated duct tape) unless it is installed in combination with mastic and draw bands. Mastic and draw bands alone are adequate for sealing most connections. Cloth-backed, rubber-adhesive duct tape may be used to hold the outer vapor barrier in place or for some purpose other than prevention of duct leakage. Cloth-backed rubber adhesive duct tape alone is not adequate to serve as an air-sealing method or as a mechanical connection.

The enforcement of these minimum standards is normally the responsibility of the building official; however, HERS Raters will also verify compliance with this requirement in conjunction with duct leakage verification.

#### 4.4.1.7 Product Markings

*§150.0(m)2A, §150.0(m)6*

All factory-fabricated duct systems must meet UL 181 for ducts and closure systems and be labeled as complying with UL 181. Collars, connections, and splices are considered to be factory-fabricated duct systems and must meet the same requirement.

Insulated flexible duct products installed to meet this requirement must include labels, in maximum intervals of 3 ft, showing the R-value for the duct insulation (excluding air films, vapor barriers, or other duct components), based on the tests and thickness specified in §150.0(m)4 and §150.0(m)5C.

#### 4.4.1.8 Dampers to Prevent Air Leakage

*§150.0(m)7*

Fan systems that exhaust air from the building to the outside must be provided with back draft or automatic dampers.

*§150.0(m)8*

Gravity ventilating systems must have an automatic or readily accessible, manually operated damper in all openings to the outside, except combustion inlet and outlet air openings and elevator shaft vents. This includes clothes dryer exhaust vents when installed in conditioned space.

#### 4.4.1.9 Protection of Insulation

*§150.0(m)9*

Insulation must be protected from damage, including damage from sunlight, moisture, equipment maintenance, and wind, but not limited to the following:

1. Insulation exposed to weather must be suitable for outdoor service – for example, protected by aluminum, sheet metal, painted canvas, or plastic cover.
2. Cellular foam insulation shall be protected as above or painted with a coating that is water-retardant and shields from solar radiation that can degrade the material.

#### 4.4.1.10 Ducts in Concrete Slab

Ducts in a concrete slab must have R-6 insulation, but other issues will come into play. If ducts are in the soil beneath the slab or embedded in the slab, the insulation material should be designed and rated for such installation. Insulation installed in below-grade applications should resist moisture penetration. (Closed-cell foam is one moisture-resistant product.) Common premanufactured duct systems are not suitable for below-grade installations. If concrete is to be poured directly over the ducts, then the duct construction and insulation system should be sturdy enough to resist the pressure and not collapse. Insulation should be of a type that will not compress, or it should be inside a rigid duct enclosure. The only time that common flex ducts are suitable in a below-grade application is when a channel is provided in the slab.

#### 4.4.1.11 Porous Inner Core Flex Duct

*§150.0(m)10*

Over time, the outer vapor barrier of flex duct can degrade and be easily damaged. Therefore, porous inner core flex duct must have a non-porous layer or air barrier between the inner core and the outer vapor barrier.

#### 4.4.1.12 Duct System Sealing and Leakage Testing

*§150.0(m)11*

Duct system sealing and leakage testing is mandatory in all climate zones. Duct systems in newly constructed single-family dwellings and, townhouses are required to comply with the requirements. For single-family dwellings and townhouses where the air-handling unit is installed and ducts are connected directly to the air handler, the total leakage of the duct system must be 5 percent or less of the nominal system air handler airflow. For single-family dwellings and townhouses inspected at the "rough-in" stage of construction, where the air-handling unit is not installed, the



total leakage of the duct system shall not exceed 4 percent of the nominal systems air handler airflow.

The duct system leakage must be verified according to the applicable procedures outlined in RA3.1.4.

Alterations and additions to ducted systems in existing buildings in all climate zones are also required to comply with applicable maximum leakage criteria. Refer to Chapter 9 for more information on duct sealing and leakage testing for existing buildings.

#### **4.4.1.13 Duct Leakage Testing for Multiple Duct Systems With Common Return Ducts**

If there are two or more duct systems in a building that are tied together at a common return duct, then each duct system should be tested separately, including the shared portion of the return duct system in each test. Under this scenario, the portions of the second duct system that is not being tested must be completely isolated from the portions of the ducts that are being tested, so the leakage from second duct system does not affect the leakage rate from the side that is being tested.

Figure 4-3 represents the systems that are attached to a shared return boot or remote return plenum. In this case, the point in the return system that needs to be blocked off is readily accessible through the return grille.

The “duct leakage averaging,” where both systems are tested together as though it is one large system and divided by the combined tonnage to get the target leakage, may not be used as it allows a duct system with more the 5 percent leakage to pass if the leakage of the combined system is 5 percent or less.

**Figure 4-3: Two Duct Systems with a Common Return Duct**

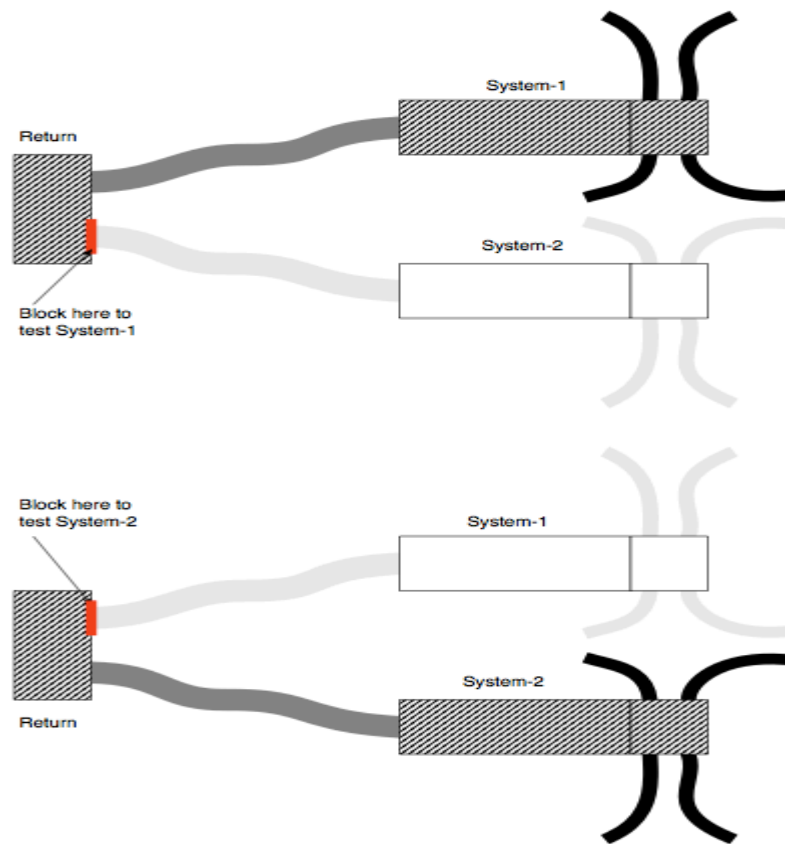

Source: California Energy Commission

#### 4.4.1.14 Air Filtration

*§150.0(m)12*

Air filtration is used in forced air systems to protect the equipment from dust accumulation that could reduce the capacity or efficiency of the system. Preventing dust buildup may also prevent the system from becoming a host to biological contaminants such as mold, especially if dust is deposited on cooling coils that become wet from water condensation during comfort cooling operation. Air filter efficiencies of Minimum Efficiency Reporting Value (MERV) 6 to MERV 8 are sufficient for protection from these large airborne dust particles. Air filter efficiencies of at least MERV 13 are needed to protect occupants from exposure to the smaller airborne particles that are known to adversely affect respiratory health. These smaller particles are often referred to as PM 2.5 which refers to particulate matter of 2.5 microns. PM2.5 is produced from combustion such as that resulting from cooking in the kitchen and from exhaust from motor vehicles that enters a dwelling through ventilation openings and infiltration.

#### 4.4.1.14.1 Air Filter Pressure Drop

Energy Code Section 150.0(m)12Bii requires all systems to be designed to accommodate the clean-filter pressure drop imposed by the system air filter device(s). This applies to space-conditioning systems and to the ventilation system types described in Section 4.4.1.14.2 below. The design airflow rate, and maximum allowable clean-filter pressure drop at the design airflow rate applicable to each air filter device shall be determined and posted on a sticker or label by the installer inside the filter grille or near the filter rack, according to Section 4.4.1.14.5 below.

Designers of space-conditioning systems must determine the total of the system external static pressure losses from filters, coils, ducts, and grilles, such that the sum is not greater than the available static pressure of the air handling unit at the design airflow rate. Therefore, air filters should be sized to minimize static pressure drop across the filter during system operation.

The air filter pressure drop can be reduced by increasing the amount of air filter media surface area available to the system airflow. Increased media surface area can be accomplished by adjusting one, two, or all three of the following factors:

- a. *The number of pleats of media per inch inside the air filter frame.* The number of pleats per inch inside the filter frame is determined by the manufacturer's filter model design and is held constant for all filter sizes of the same manufacturer's model. For example, all 3M Filtrete™ 1900 filters will have the same media type, the same MERV rating, and the same number of pleats of media per inch inside the filter frame regardless of whether the nominal filter size is 20" X 30" or 24" X 24", and so forth. Generally, as the number of pleats per inch is increased, the pressure drop is reduced if all other factors remain constant. The pressure drop characteristics of air filters vary widely between air filter manufacturers and between air filter models, largely because of the number of pleats per inch in the manufacturer's air filter model design. System designers and system owners cannot change the manufacturer's filter model characteristics, but they can select a superior air filter model from a manufacturer that provides greater airflow at a lower pressure drop by comparing the filter pressure drop performance shown on the air filter manufacturer's product label (see example label in Figure 4-5).
- b. *The face area of the air filter and filter grille.* Face area is the nominal cross-sectional area of the air filter, perpendicular to the direction of the airflow through the filter. Face area is also the area of the filter grille opening in the ceiling or wall. The face area is determined by multiplying the length times width of the filter face (or filter grille opening). The nominal face area for a filter corresponds to the nominal face area of the filter grille in which the filter is installed. For example, a nominal 20" X 30" filter has a face area of 600 in<sup>2</sup> and would be installed in a nominal 20" X 30" filter grille. Generally, as the

total system air filter face area increases, the pressure drop is reduced if all other factors remain constant. Total system air filter face area can be increased by specifying a larger area filter/grille, or by using multiple return filters/grilles and summing the face areas. The filter face area is specified by the system designer or installer.

- c. *The depth of the filter and filter grille.* Air filter depth is the nominal filter dimension parallel to the direction of the airflow through the filter. Nominal filter depths readily available for purchase include one, two, four, and six inches. Generally, as the system air filter depth increases, the pressure drop is reduced if all other factors remain constant. For example, increasing filter depth from one inch to two inches nominally doubles the filter media surface area without increasing the filter face area. The filter depth is specified by the system designer or installer.

#### 4.4.1.14.2 **Air Filter Particle Removal Efficiency Requirements – MERV 13**

An air filter with a particle removal efficiency equal to or greater than MERV 13, or a particle size efficiency rating equal to or greater than 50 percent in the 0.30-1.0 micrometer ( $\mu\text{m}$ ) range, and equal to or greater than 85 percent in the 1.0-3.0  $\mu\text{m}$  range is required for the following systems:

- a. Mechanical space conditioning (heating or cooling) systems with a total of more than 10 feet of duct. The total is determined by summing the lengths of all the supply and return ducts for the forced-air system.
- b. Mechanical supply-only ventilation systems that provide outside air to an occupiable space.
- c. The supply side of mechanical balanced ventilation systems, including heat recovery ventilation systems and energy recovery ventilation systems that provide outside air to an occupiable space.

Evaporative coolers are exempt from the air filtration requirements

#### 4.4.1.14.3 **Air Filter Requirements for Space-Conditioning Systems:**

Space-conditioning systems may use any of the three following compliance approaches:

- a. Install a filter grille or accessible filter rack that accommodates a minimum 2-inch depth filter and install the appropriate filter.
- b. Install a filter grille or accessible filter rack that accommodates a minimum 1" depth filter and install the appropriate filter. The filter/grille must be sized for a velocity of  $\leq 150$  ft per minute. The installed filter must be

labeled to indicate the pressure drop across the filter at the design airflow rate for that return is  $\leq 0.1$  inch water column (w.c. [25 PA]).

Use the following method to calculate the 1" depth filter face area required. Divide the design airflow rate (ft<sup>3</sup>/min) for the filter grille/rack by the maximum allowed face velocity 150 ft/min. This yields a value for the face area in ft<sup>2</sup>. Since air filters are sold using nominal sizes in terms of inches, convert the face area to in<sup>2</sup> by multiplying the face area (ft<sup>2</sup>) by a conversion factor of 144 in<sup>2</sup>/ft<sup>2</sup>. Summarizing:

$$\text{Filter Nominal Face Area (in}^2\text{)} = \text{airflow (CFM)} \div 150 \times 144 \quad \text{Equation 4.4-1}$$

- c. Comply with Energy Code Tables 150.0-B and C (Table 4-10 and Table 4-11), which prescribe the minimum total system nominal filter face area and return duct size(s). The installed filter must be labeled to indicate the pressure drop across the filter at the design airflow rate for that return is  $\leq 0.1$  inch w.c. (25 PA). This option is an alternative to the Section 150.0(m)13 requirement for HERS-verified fan efficacy and airflow rate but requires instead a HERS verification of the return duct design.

#### 4.4.1.14.4 **Air Filter Requirements for Ventilation Systems**

- a. Filters with a depth of 1" or greater are allowed.
- b. The design airflow rate, and maximum allowable clean-filter pressure drop at the design airflow rate applicable to each air filter device must be determined by the system designer or installer and that information must be posted on a sticker by the installer inside or near the filter grille/rack according to Section 4.4.1.14.5 below.
- c. Ventilation systems must deliver the volume of air specified by §150.0(o) with filters in place.

#### 4.4.1.14.5 **Filter Access and Filter Grille Sticker – Design Airflow and Pressure Drop**

All filters used in all system types must be accessible to facilitate replacement.

- a. **Air filter grille sticker.** The design airflow rate and maximum allowable clean-filter pressure drop at the design airflow rate applicable to each air filter grille/rack must be determined by the designer/installer and posted on a sticker placed by the installer inside or near the filter grille/rack. The design airflow and initial resistance posted on this sticker should correspond to the conditions used in the system design calculations. This requirement applies to space conditioning systems

and to the ventilation system types described in Section 4.4.1.14.2 above.

An example of an air filter grille sticker showing the design airflow and pressure drop for the filter grille/rack is shown in Figure 4-4.

- b. **Air filter manufacturer label.** Space-conditioning system filters are required to be labeled by the manufacturer to indicate the pressure drop across the filter at several airflow rates. For the system to comply, and to ensure adequate airflow for efficient heating and cooling equipment operation, the manufacturer's air filter label (Figure 4-5) must display information that indicates the filter can meet the design airflow rate for that return grille/rack at a pressure drop  $\leq$  the value shown on the installer's filter grille sticker (Figure 4-4). This requirement does not apply to the ventilation system types described in Section 4.4.1.14.2.

**Figure 4-4: Example of Installer's Filter Grille Sticker**

<b>Air Filter Performance Requirement</b>	<b>Air Filter Performance Requirement</b>	<b>Maintenance Instructions</b>
<b>Airflow Rate (CFM)</b> Must be greater than or equal to the value shown	<b>Initial Resistance (IWC)</b> Must be less than or equal to the value shown	Use only replacement filters that are rated to simultaneously meet both of the performance requirements specified on this sticker:
750	0.1	Left blank

Source: California Energy Commission

**Figure 4-5: Example Manufacturer's Filter Label**

MERV	( $\mu$ m)	0.30-1.0	1.0-3.0	3.0-10	Airflow Rate (CFM)	615	925	1230	1540	2085*	*Max Rated Airflow
13	PSE (%)	62	87	95	Initial Resistance (IWC)	0.07	0.13	0.18	0.25	0.38	

Source: California Energy Commission

#### 4.4.1.14.6 **Air Filter Selection**

For a filter to meet the system specifications for airflow and pressure drop, it must be rated by the manufacturer to provide more than the specified airflow at less than the specified pressure drop. It is unlikely that a filter will be available that is rated to have the exact airflow and pressure drop ratings specified, so filters should be selected that are rated to have less than the specified pressure drop at the specified airflow rate, otherwise select filters that are rated to have greater

than the specified airflow rate at the specified pressure drop. See Figure 4-4 for an example of an installer's filter grille sticker that provides an air filter rating specification for minimum airflow of 750 CFM at maximum pressure drop 0.1 inch w.c.

Manufacturers of air filters may make supplementary product information available to consumers that will assist with selecting the proper replacement filters. This product information may provide more detailed information about the filter model airflow and pressure drop performance – details such as airflow and pressure drop values that are intermediate values that lie between the values shown on their product label. The information may be published in tables, graphs, or presented in software applications available on the internet or at the point of sale.

Figure 4-6 below shows a graphical representation of the initial resistance (pressure drop) and airflow rate ordered pairs given on the example air filter manufacturer's label shown in Figure 4-5 above. The graph in Figure 4-6 makes it possible to visually determine the airflow at 0.1 inch w.c. pressure drop for which the values are not shown on the manufacturer's filter label.

If there is no supplementary manufacturer information available, and it is necessary to determine the performance of a filter model at an airflow rate or pressure drop between two values shown on a manufacturer's label, linear interpolation may be used. Linear interpolation apps are readily available on the internet, and formulas for linear interpolation are shown below.

The linear interpolation method may be used to determine an unknown pressure drop corresponding to a known airflow rate by use of Equation 4-1a, or it may also be used to determine an unknown airflow rate corresponding to a known pressure drop by use of Equation 4-1b.

$$p = p1 + [(f - f1) \div (f2 - f1)] \times (p2 - p1) \quad \text{Equation 4-1a}$$

where:

f = a known flow value between  $f_1$  and  $f_2$

p = the unknown pressure drop value corresponding to f.

$p_1$  and  $p_2$  = known values that are less than and greater than p respectively.

$f_1$  and  $f_2$  are the known values corresponding to  $p_1$  and  $p_2$ .

$$f = f_1 + [(p-p_1) \div (p_2-p_1)] \times (f_2 - f_1) \quad \text{Equation 4-1b}$$

where:

$p$  = a known pressure drop value between  $p_1$  and  $p_2$

$f$  = the unknown flow value corresponding to  $p$ .

$f_1$  and  $f_2$  = known values that are less than and greater than  $f$  respectively.

$p_1$  and  $p_2$  are the known values corresponding to  $f_1$  and  $f_2$ .

See Example 4-1 for sample calculations that determine the rated airflow of the filter corresponding to a known pressure drop specification (0.1 inch w.c.).

**Figure 4-6. Plot of Pressure drop vs. Airflow for a 20" X 30" X 1" Depth Air Filter From Manufacturer Label Information**

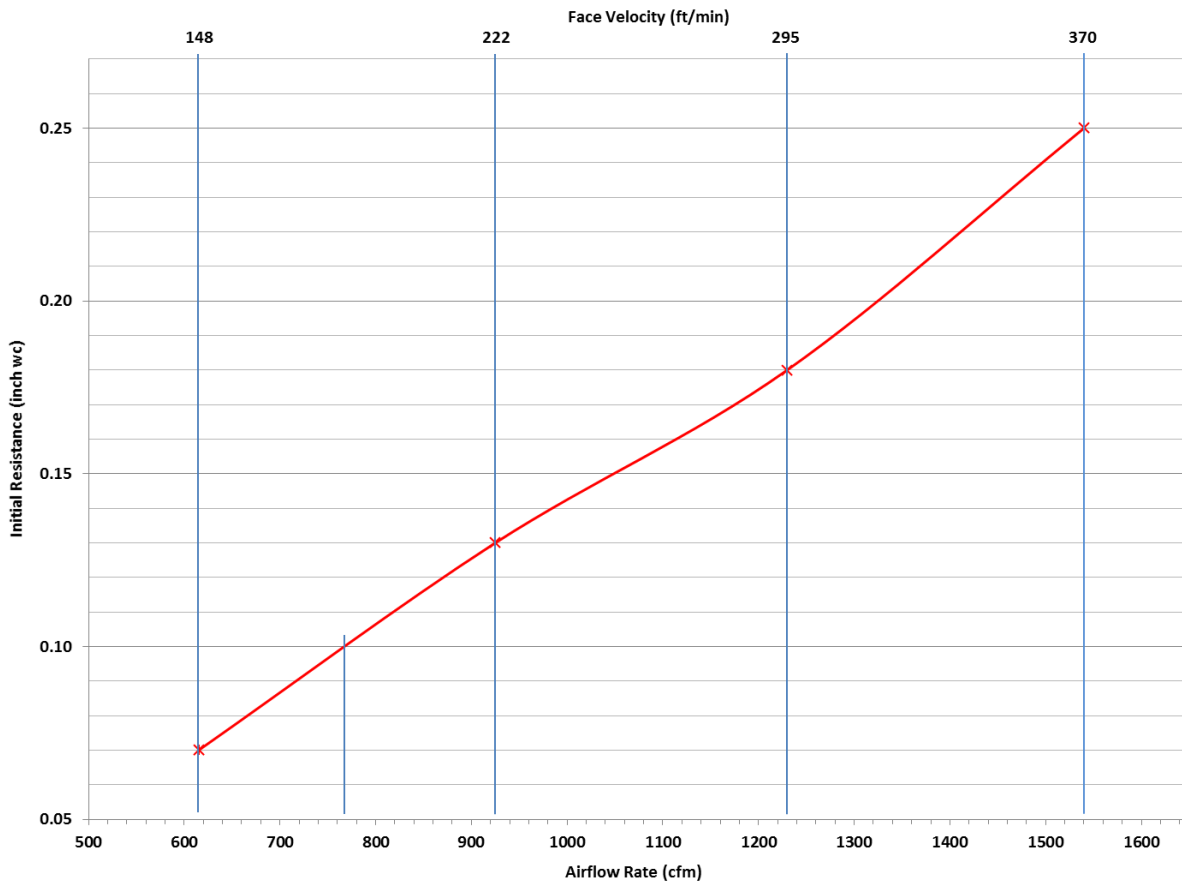

Source: California Energy Commission

#### 4.4.1.14.7 Preventing Bypass

Any gaps around an air filter allows air to bypass the filter. The Energy Code requires that filter racks and grilles use gaskets, sealing, or other means to close gaps around inserted filters and prevent air from



bypassing the filter. Filter racks and grilles include any device that houses the air filter used to satisfy the air filtration requirements.

---

#### Example 4-1– Filter Selection Using Linear Interpolation

**Question:**

Does the air filter label in Figure 4-5 indicate the filter would meet the airflow (750 CFM) and pressure drop (0.1 inch w.c.) requirements shown on the installer filter grille sticker in Figure 4-4? How can I determine the filter's airflow rate at 0.1 inch w.c. for the manufacturer's filter label shown in Figure 4-5?

**Answer:**

The filter must be rated to provide greater than 750 CFM at the specified 0.1 inch w.c. pressure drop, or equivalently: the filter must be rated to provide a pressure drop less than 0.1 inch w.c. at the specified 750 CFM.

Referring to Equation 4-1b, we calculate the unknown value "f" in CFM that corresponds to the known value "p" of 0.1 inch w.c.

Referring to Figure 4-5:  $p_1=0.07$ ,  $p_2=0.13$ ,  $f_1=615$ ,  $f_2=925$ , and applying Equation 4-1b:  $615 + [(0.1-0.07) \div (0.13-0.07)] \times (925-615)$  yields 770 CFM.

Therefore, since the filter is rated for greater than 750 CFM at 0.1 inch w.c., the filter complies.

---

#### Example 4-2– Filter Sizing

**Question:**

I am installing a 1,200 CFM furnace in a new house. It has a 20" x 20" x 1" inch filter rack furnished with a 1" depth filter installed in the unit. Is this filter in compliance?

**Answer:**

The nominal face area of the filter rack is 20" x 20" = 400 in<sup>2</sup>, and since it is a 1" filter, the face area may not be less than 1,200 (CFM)/150 (ft/min) x 144 (in<sup>2</sup> / ft<sup>2</sup>) = 1,152 in<sup>2</sup>. Therefore, this filter installation does not comply.

#### Example 4-3

**Question:**

For the same 1,200 CFM furnace, what other options do I have?

**Answer:**

Option 1: The filter will comply if it has a depth of 2 inches or more and is properly sized by the system designer such that the duct system as a whole will be capable of meeting the HERS verification for fan efficacy specified in Section 150.0(m)13.

Otherwise, the required total system filter face area of 1,152 in<sup>2</sup> must be met using multiple remote wall or ceiling filter grilles for which the sum of the face areas is equal to or greater than 1152 in<sup>2</sup>, and the filters must be rated for pressure drop of 0.1 inch w.c. or less at the design airflow rates of each filter grille.

Option 2: Table 150.0-B may be used for compliance. If the air conditioner is rated at 3 tons and two return ducts sized at 16" and 14" or larger are provided, the total filter/grille nominal area may be reduced to 900 in<sup>2</sup>, or 450 in<sup>2</sup> per filter grille. However, the filters still must have a pressure drop of 0.1 inch or less at 600 CFM (based on filter manufacturer label data).

For any filter, the pressure drop, efficiency, and length of time the filter can remain in operation without becoming fully loaded with dust, can all be improved by using filters that are deeper than 1". As the depth of the filter is increased, the pressure drop across the filter at the same face area will be greatly reduced.

---

---

#### Example 4-4

##### **Question:**

I am installing a ductless split system in a space that is being added on to the house. Must I use the designated MERV 13 filter?

##### **Answer:**

No. The filtration requirements do not apply unless there is at least 10 feet of duct attached to the unit.

#### Example 4-5

##### **Question:**

My customer has allergies and wants a MERV 16 or better filter. Is this in compliance?

##### **Answer:**

Yes. MERV rated filtration greater than MERV 13 meets (exceeds) the minimum particle removal efficiency requirement; thus, it may be used provided all other applicable requirements in Section 150.0(m)12 are complied with.

---

#### 4.4.1.15 **Forced-Air System Duct Sizing, Airflow Rate, and Fan Efficacy**

##### **§150.0(m)13**

Adequate airflow is critical for cooling equipment efficiency. Further, it is important to maintain adequate airflow without expending excessive fan power.

Section 150.0(m)13 requires system airflow and watt draw to be HERS-verified. See RA3.3 for the applicable HERS verification procedures.

Forced-air systems that provide cooling must comply with either the airflow rate and fan efficacy verification, or may comply with the return duct design specifications given in Tables 150.0-B and C.

1. Airflow and watt draw measurement and determination of fan efficacy:

When using the airflow (CFM/ton) and fan efficacy (watt/CFM) method, the following criteria must be met:

- a. Provide airflow through the return grilles that is equal to or greater than
  - 350 CFM per ton of nominal cooling capacity for systems that are not small-duct high-velocity systems.
  - 250 CFM per ton for small duct, high velocity systems.

Nominal cooling capacity. To determine the required airflow for compliance in CFM/ton, the nominal cooling capacity of the system in tons must be known. The nominal cooling capacity system may be obtained from the manufacturer's product literature or from listings of certified product ratings from organizations such as AHRI, but the nominal capacity is usually shown in the unit model number on the manufacturer's nameplate attached to the outdoor condensing unit. A two- or three-digit section of the manufacturer's model number indicates the nominal capacity in thousands of BTU/hour. Given that there are 12,000 BTU/hour per ton of cooling capacity, the nameplate will display something similar to one of the following number groupings: "018" which represents 1.5 tons; "024," which represents 2 tons; "030," which represents 2.5 tons; "036," which represents 3 tons; "042," which represents 3.5 tons; "048," which represents 4 tons; or "060," which represents 5 tons.

- b. At the same time, the fan watt draw must be less than or equal to
  - 0.45 watts per CFM for gas furnaces.
  - 0.58 watts per CFM for air handling units that are not gas furnaces.
  - 0.62 watts per CFM for small duct, high velocity systems.

The methods for measuring the air-handling unit watt draw are described in RA3.3. Three acceptable apparatuses are:

- a. A portable watt meter.
- b. An analog utility revenue meter.
- c. A digital utility revenue meter.

Note: When measuring fan watt draw in package air conditioners or heat pumps, it is recommended to use a portable true power clamp-on meter to

provide flexibility for isolating the correct fan wires. These meters may need to be high-voltage-capable.

There are three acceptable methods for determining compliance with the system airflow requirement. They are described in RA3.3 and use one of the following:

- a. An active or passive flow capture hood to measure the total airflow through the return grill(s).
- b. Flow grid device(s) at the return grill(s) or other location where all the central fan airflow passes through the flow grid.
- c. Fan flow meter device (also known as a duct blaster) to perform the plenum pressure matching procedure.

The flow grid and the fan flow meter methods both require access to static pressure measurements of the airflow exiting the cooling coil, which requires use of a HSPP or PSPP (Section RA3.3.1.1).

The contractor must install either a hole for the placement of a static pressure probe (HSPP) or provide a permanently installed static pressure probe (PSPP) as shown in Figure 4-5 below and RA3.3.

**Figure 4-5: Location of the Static Pressure Probe**

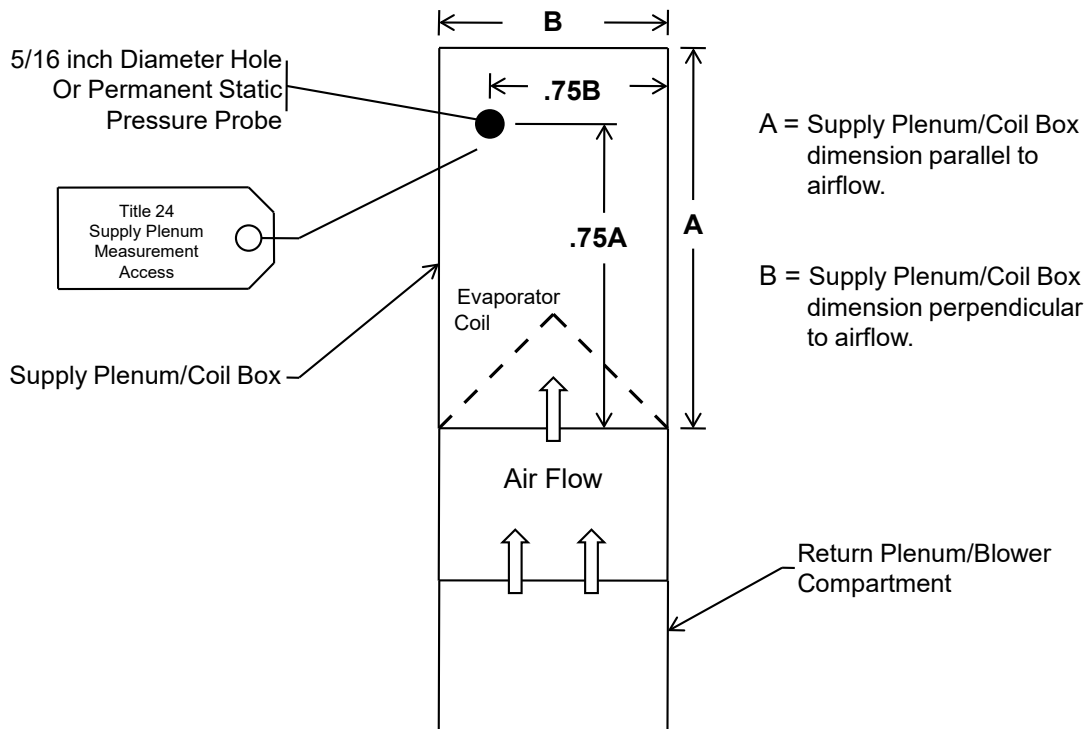

Source: California Energy Commission

The HSPP or PSPP simplifies cooling coil airflow measurement when using devices/procedures that depend on supply plenum pressure measurements.

2. Return Duct System Design Method – This method allows the designer to specify, and the contractor to install, a system that does not have to be tested for airflow and fan efficacy. This method can be used for systems with either one, or two return grilles. Each return shall not exceed 30 feet as measured from the return plenum to the filter grille. When bends are needed, sheet metal elbows are desirable. Each return can have up to 180 degrees of bend, and flex duct can have no more than 90 degrees of bend. To use this method, the designer and installer must provide return system sizing that meets the appropriate criteria in Energy Code Table 150.0-B and C, also shown in Table 4-10 or Table 4-11 below.

#### 4.4.1.16 Airflow and Fan Efficacy Testing Versus Return Duct Sizing

Studies have shown that adequate airflow is critical to the efficient operation of air-conditioning systems. Section 150.0(m)13B, 13C, and 13D establish mandatory requirements that are intended to ensure adequate cooling airflow through properly sized ducts and efficient fan motors.

There are two options allowed to ensure adequate air flow. The first option is to design and install the systems using standard design criteria and then have the airflow and fan efficacy (AF/FE) of the system tested and third-party verified in the field. The second option is to size the return ducts according to Table 4-10 and Table 4-11 (as specified by EXCEPTION 1 to §150.0(m)13B and D).

The California Green Code and the California Mechanical Code require that residential duct systems be designed according to ACCA Manual D, or equivalent. If reasonable care and judgment are used while designing the duct system (both return and supply ducts), and the system is designed to reasonable parameters for airflow per ton, static pressure across the fan, and friction rate, these systems should have no problem passing the diagnostic tests.

The following design guidelines can increase the chances of the system passing the AF/FE testing:

1. Right-size the HVAC system; if a 3-ton unit is enough to satisfy the cooling load, do not install a 4-ton unit “just to be safe.” Oversizing equipment can cause comfort problems and excessive energy use.
2. The HVAC designer must coordinate closely with the architect and structural engineer to make sure that the ducts will fit into the home as designed.
3. Prepare a detailed mechanical plan that can be followed in the field. If deviations must occur in the field, make sure that they are coordinated with the designer and that the design is adjusted as needed.

4. Follow Manual D for duct sizing:
  - a. Make sure that the correct duct type is being used (vinyl flex, sheet metal, rigid fiberglass, or other).
  - b. Make sure that all equivalent lengths and pressure drops are correctly accounted for (bends, plenum start collars, t-wyes, filters, grilles, registers, and so forth).
  - c. Select a furnace that will provide at least 400 CFM/ton at the desired static pressure of 125 to 150 Pa (0.5 to 0.6 inches w.c.).
  - d. Design the duct system to a static pressure across the fan of no more than 150 Pa (0.6 inches w.c.).
  - e. Consider upsizing the evaporator coil relative to the condenser to reduce the static pressure drop. This upsizing results in better airflow and slightly better capacity and efficiency. Manufacturers commonly provide performance data for such condenser coil combinations.
  - f. Consider specifying an air handler with a high efficiency (brushless permanent magnet) fan motor.
5. Install a large grill area and use a proper filter for the system.
6. Locate registers and equipment to make duct runs as short as possible.
7. Make all short-radius 90-degree bends out of rigid ducting.
8. Install flex duct properly by stretching all flex duct tight and cut off excess ducting, ensure the duct is not kinked or compressed, ensure flex duct is properly supported every 4 feet or less using 1inch strapping having less than 2 inches of sag between supports.

Consider using better quality supply and filter grilles. “Bar-type” registers have considerably better airflow performance than standard “stamped-face” registers. Refer to the manufacturer’s specifications and select accordingly.

Energy Code Tables 150.0-B and C (Table 4-9 and Table 4-11) allow for only one or two returns. There may be times where three returns are necessary on a single system. Furthermore, Table 150.0-C does not allow for deviation from the two sizes specified. For example, the table requires two 16-inch return ducts for a 3.5-ton system, but specific airflow requirements and architectural constraints may dictate something more like a 20-inch and a 14-inch. In this situation, the designers would have to rely on standard engineering principles and trust that their design will pass the AF/FE diagnostic tests.

Having adequate room to run properly sized ducts has always been an issue. Historically, duct systems have been sized to fit into the home at the expense of proper airflow. The performance of these systems, in terms of efficiency and

capacity, has suffered greatly because of this practice. These standards intend to change these practices. The home should be designed to accommodate properly sized ducts. This requires improved coordination among the architect, structural engineer, and mechanical designer earlier in the process.

Tables 150.0-B and C require the use of return grilles that are sized to achieve an optimal face velocity and static pressure drop. Tables 150.0-B and C also require the return grille devices to be labeled in accordance with the requirements in §150.0(m)12A to disclose the design airflow rate of the grille, and the maximum allowable clean-filter pressure drop for the air filter media as determined by the system design or applicable standards requirements. The nominal size of the air filter grille or air filter media should be used to calculate the return filter grille gross area for determining compliance with Tables 150.0-B and C. The nominal size of the filter grille is expected to be the same as the nominal size of the air filter media that is used in the grille and is most often the information used to identify these items for purchases. For example, a nominal 20-inch x 30-inch filter grille will use nominal 20-inch x 30-inch air filter media.

#### **4.4.1.17 Return Duct Sizing Example**

The mechanical contractor for a new home submitted the following mechanical design to the builder. It was designed using typical design specifications (400 CFM/ton at 125 Pa [0.5" w.c., friction rate = 0.1, etc.]). The system has a 4-ton condenser, and the air handler is rated for 1,600 CFM.

**Figure 4-6: Return Duct Design Option 1**

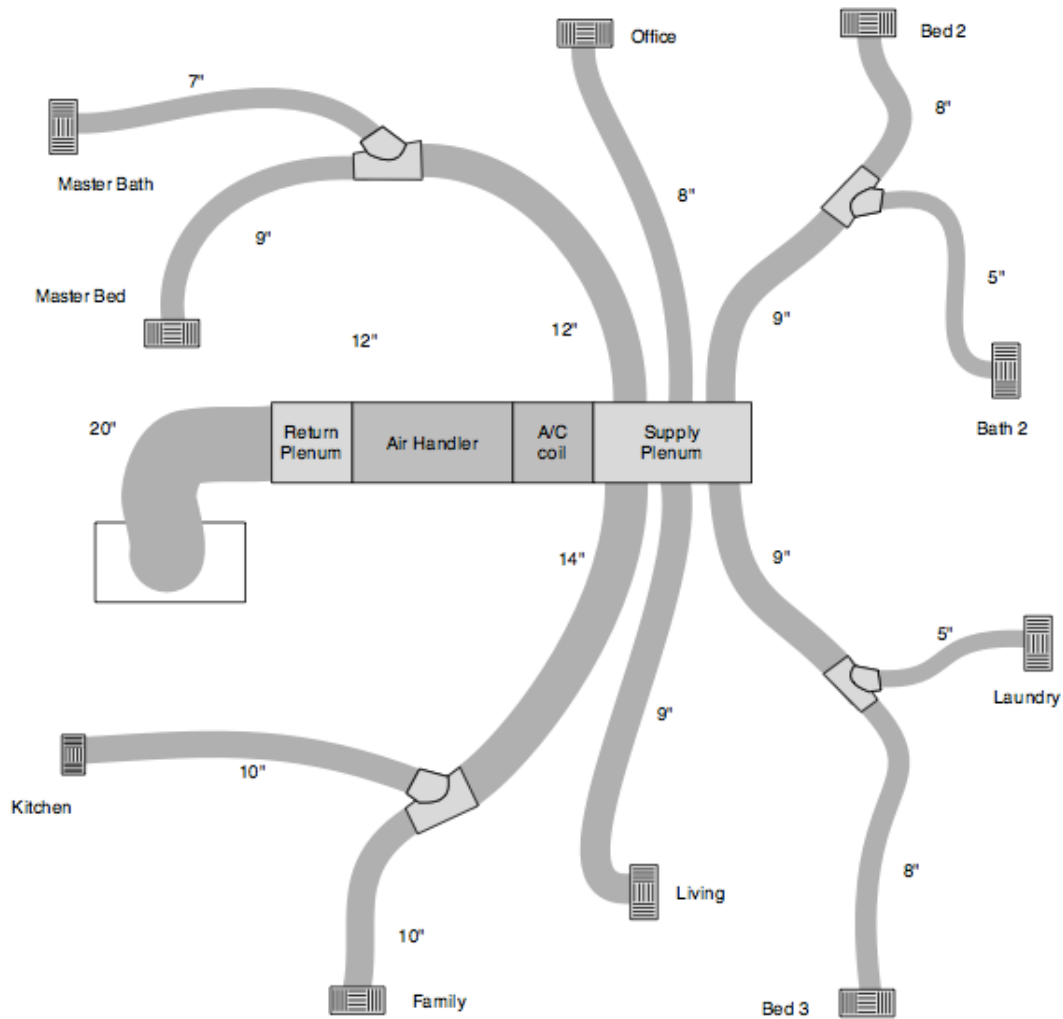

Source: California Energy Commission

Because the builder has specified a low-end air handler, he or she is concerned that the system may not pass the mandatory diagnostic testing requirement for airflow and fan efficacy. The builder requests that the system be redesigned with the return ducts sized according to Table 150.0-C. The following layout is the redesigned system (Figure 4-7). The only change is that the system now has two 18-inch return ducts and two filter grilles sized according to Table 150.0-C, rather than a 20-inch return duct and a filter grille. Because one of the return ducts had more than one 90-degree bend, one of the bends is required to be a metal elbow (to be insulated). The two return filters are 20-inch x 30-inch each and are rated by the manufacturer to show that they have a pressure drop of less than 125 Pa (0.1" w.c.) at 800 CFM each.



**Figure 4-7: Return Duct Design Option 2**

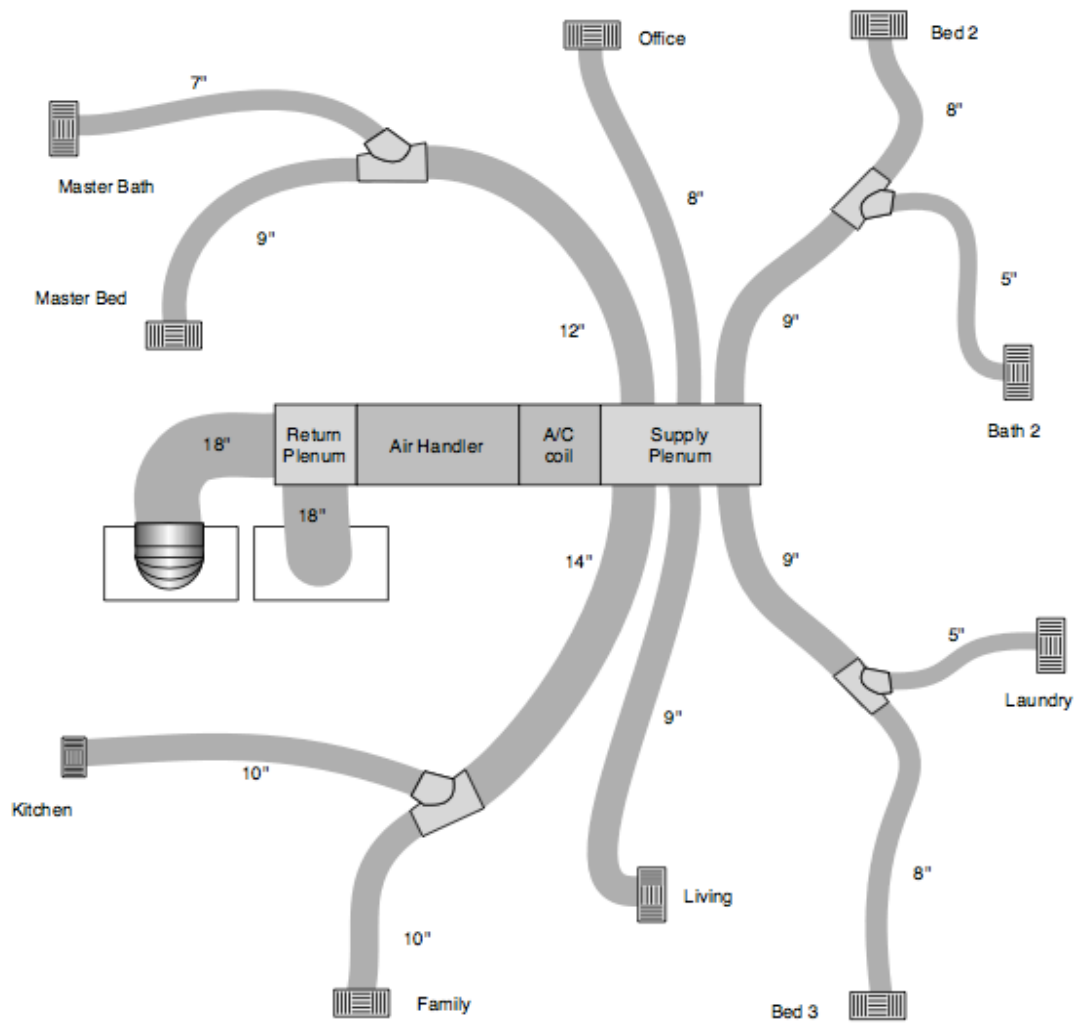

Source: California Energy Commission

**Table 4-9: Return Duct Sizing for Single Return Duct Systems**

System Nominal Cooling Capacity (Ton)	Minimum Return Duct Diameter (inch)	Minimum Total Return Filter Grille Gross Area (Inch <sup>2</sup> )
1.5	16	500
2.0	18	600
2.5	20	800

Source: Table 150-B of the Energy Code

**Table 4-10: Return Duct Sizing for Multiple Return Duct Systems  
Two Returns**

<b>System Nominal Cooling Capacity (Ton)</b>	<b>Return Duct 1 Minimum Diameter (inch)</b>	<b>Return Duct 2 Minimum Diameter (inch)</b>	<b>Minimum Total Return Filter Grille Gross Area (inch<sup>2</sup>.)</b>
1.5	12	10	500
2.0	14	12	600
2.5	14	14	800
3.0	16	14	900
3.5	16	16	1000
4.0	18	18	1200
5.0	20	20	1500

Source: Table 150-C of the Energy Code

#### 4.4.1.18 Zonally Controlled Central Forced-Air Cooling Systems

The primary purpose of zoning ducted air conditioners, heat pumps, and furnaces is to improve comfort. Increased comfort is attained by having the capacity of the HVAC system (cooling or heating delivered) follow the shift in load as it changes across the house. For example, it is common for two-story homes to be too hot on the second floor in summer and winter. Zoning has the capability of diverting more of the HVAC capacity to the area with the increased load. Another common example is a home with a significant area of west-facing and east-facing windows. In the summer, the east rooms overheat in the morning, and the west rooms overheat in the afternoon.

Providing the most agreeable temperature to all the zones is comfortable, but it carries with it the possibility of increased energy consumption. Since the most common home is single-zoned and has only one thermostat placed near the center of the house, temperatures in the rooms distant from that thermostat will vary, sometimes significantly. If zoning is added, the more distant rooms may be conditioned to a more comfortable temperature. This increased conditioning requires more energy. When designed correctly, zoning allows only the zones that need conditioning to be conditioned, thus potentially saving energy.

It is common for single-speed zonally controlled central forced-air cooling systems to produce lower total system airflow through the returns when fewer than all zones are calling for conditioning. The reduced airflow lowers the sensible efficiency of

single-stage heating or cooling equipment. Two primary causes of lower airflow in multiple zone-dampened systems are:

1. Restriction of some system supply ducts by closing zoning dampers in zones that do not need additional cooling, while other zones do need cooling.
2. Recirculation of already-cooled air from the supply plenum directly back to the return plenum without first delivering the cooled air to the conditioned space by use of a bypass duct.

To prevent the lower efficiency that results from reduced system airflow or from recirculated bypass duct airflow, single-speed compressor zonally controlled central cooling systems must demonstrate they simultaneously meet mandatory fan efficacy and airflow requirements in all zonal control modes, which is possible only with a superior duct system design that does not restrict the system total airflow when fewer than all zones are calling for conditioning, and does not use a bypass duct. § 150.1(c)13 prohibits use of bypass ducts prescriptively, but bypass ducts may be used if the efficiency penalty due to the reduced airflow through the return grille is modeled as described in Section 4.4.1.19 below.

Multispeed or variable-speed compressor-type zonally controlled cooling systems are not required to verify mandatory fan efficacy and airflow requirements in all zonal control modes; however, these systems must be HERS-verified to confirm they meet the mandatory fan efficacy and airflow requirements with the compressor on high speed and all zones calling for cooling.

#### **4.4.1.19 Zonally Controlled Cooling Systems – Airflow and Fan Efficacy Requirements**

Recent studies have shown that zonally controlled cooling systems with or without bypass dampers (multiple zones served by a single air handler with motorized zone dampers), usually do not meet the airflow and fan efficacy (AF/FE) requirements when fewer than all zones are calling. The energy penalty that results from this is greater than the benefit of having zonal control; therefore, zonal control is no longer simply assumed to be a “better-than-minimum” condition, and there are special compliance requirements for these systems.

Zonal control accomplished by using multiple single-zone systems is not subject to the requirements specified in Energy Code Section 150.0(m)13C.

Two-speed and variable-speed compressors are considered multispeed. Multispeed compressors allow the system capacity to vary to match reduced cooling loads more closely when fewer than all zones call for cooling. Therefore, an exception to Section 150.0(m)13C gives multispeed compressor systems special consideration when used in zoned systems and these systems are not required to verify performance in all zonal control modes. Instead, the airflow and fan efficacy testing is required to be

performed only at the highest speed when all zones call for cooling. Zoned systems with single-speed compressors must be tested and pass in all operating modes.

An exception to Section 150.0(m)13C allows single-speed compressor systems to comply with HERS verification of the *mandatory* AF/FE requirements only at the highest fan speed when all zones call for cooling. The exception applies provided the system also uses the *performance* compliance approach and complies with HERS verification of the requirements for AF/FE in all zonal control modes specified by the software user input for minimum airflow rate when fewer than all zones call for cooling. Single-speed compressor systems, with or without bypass dampers, are less likely to meet the *mandatory* AF/FE requirements in Section 150.0(m)13C with fewer than all zones calling for cooling. Therefore, the performance compliance software calculates a penalty for the reduced airflow (specified by the user) during operation when fewer than all zones call for cooling. Other energy features for the building must offset this penalty for reduced airflow when fewer than all zones call for cooling. In the performance compliance software, if the system is modeled as a zoned system with a single-speed compressor, the minimum allowable airflow drops to 150 CFM/ton. But because the standard house is assumed to have an airflow of 350 CFM/ton, there is a penalty imposed on the compliance calculation unless the designer specifies a value of 350 or higher. Entering a value between 150 and 350 can lessen the penalty resulting from the minimum allowed value of 150 CFM/ton.

It is extremely important that the energy consultant model airflow and fan efficacy values that are reasonable and can be verified by a HERS Rater; otherwise, the system will fail HERS verification, and the compliance calculations will have to be revised to specify user input equivalent to the actual values that could pass HERS verification. Energy consultants should coordinate with the HVAC designer before registering the certificate of compliance.

Bypass dampers may be installed only if the certificate of compliance specifically states that the system was modeled as having a bypass damper.

Example:

1. A home is to be built with a heat pump connected to a zoned system (two zones) with a single-speed compressor and bypass ducts. From experience, the HVAC contractor knows that it will not be possible to meet the 350 CFM/ton requirement, but 275 CFM/ton is likely.
2. The energy consultant models the system in the proposed house with 275 CFM/ton and 0.45 W/CFM (value for a gas furnace). Because the standard house assumes 350 CFM/ton, there is an energy penalty that must be made up by including other better-than-standard features in the performance compliance input, but the penalty is not as large as it would be at a value of 150 CFM/ton.

3. 275 CFM/ton must be tested in all control modes.
4. The home is built, and the system is verified by a rater and passes at 287 CFM/ton with one zone calling, 298 CFM/ton with the other zone calling, and 372 CFM/ton with both zones calling. The system is also measured with all zones calling to confirm it meets or exceeds 350 CFM/ton.
5. If this same home was to be built with a multispeed compressor, it would be tested only with all zones calling, but the target airflow would be no less than the mandatory 350 CFM/ton. Compliance credit can be achieved by modeling airflows greater than the mandatory CFM/ton and/or fan efficacies less than the mandatory watts/CFM.

**Table 4-11: Single-Zone Ducted Central Forced-Air Cooling Systems  
Single-Zone Ducted Cooling Systems  
(Single Zone Off a Single Air Handler)**

Compressor Type	Mandatory Requirements for Airflow and Fan Efficacy	Performance Compliance Option Proposed System Defaults	Performance Compliance Option Modeled Airflow and Fan Efficacy
Single-Speed, Multispeed, or Variable-Speed:  Testing Performed on Highest Speed only	<p>Airflow:</p> <ul style="list-style-type: none"> <li>• <math>\geq 350</math> CFM/ton if not a small duct high velocity type</li> <li>• <math>\geq 250</math> CFM/ton if is a small duct high velocity (SDHV) type</li> </ul> <p>Fan Efficacy:</p> <ul style="list-style-type: none"> <li>• <math>\leq 0.45</math> W/CFM for gas furnaces (GF)</li> <li>• <math>\leq 0.58</math> W/CFM for air handlers that are not gas furnaces (non-GF)</li> <li>• <math>\leq 0.62</math> W/CFM for SDHV type</li> </ul> <p>Exception: Airflow and Fan Efficacy HERS verification not required if return system meets Tables 150.0-B or C. However, HERS verification that return duct installation meets Tables 150.0-B or C is required</p>	<p>Airflow:</p> <ul style="list-style-type: none"> <li>• 350 CFM/ton (non-SDHV)</li> <li>• 250 CFM/ton (SDHV)</li> </ul> <p>Fan Efficacy:</p> <ul style="list-style-type: none"> <li>• 0.45 W/CFM (GF)</li> <li>• 0.58 W/CFM (non-GF)</li> <li>• 0.62 W/CFM (SDHV)</li> </ul>	<p>Airflow:</p> <ul style="list-style-type: none"> <li>• <math>\geq 350</math> CFM/ton (non-SDHV)</li> <li>• <math>\geq 250</math> CFM/ton (SDHV) and/or</li> </ul> <p>Fan Efficacy:</p> <ul style="list-style-type: none"> <li>• <math>\leq 0.45</math> W/CFM (GF)</li> <li>• <math>\leq 0.58</math> W/CFM (non-GF)</li> <li>• <math>\leq 0.62</math> W/CFM (SDHV)</li> </ul>

Source: California Energy Commission

**Table 4-12: Zonally Controlled Central Forced-Air Cooling Systems  
Zoned Ducted Cooling Systems (Multiple Zones off a Single Air Handler)**

<b>Compressor Type</b>	<b>Mandatory Requirements for Airflow and Fan Efficacy <sup>1</sup></b>	<b>Performance Compliance <sup>2</sup> Proposed System Defaults <sup>3</sup></b>	<b>Zoned Ducted Cooling Systems (Multiple Zones off a Single Air Handler) Modeled Airflow and Fan Efficacy</b>
Single Speed	<p>Airflow: ≥ 350 CFM/ton (non-SDHV)</p> <p>Fan Efficacy: ≤ 0.45 W/CFM (GF) ≤ 0.58 W/CFM (non-GF)</p> <p>For Prescriptive Compliance Method, verification is mandatory in all zonal control modes. When Performance Compliance Method is used, verification of the <i>mandatory</i> requirements are performed only at highest capacity operation with all zones calling, and the additional performance targets for W/CFM and CFM/ton specified by the user in the performance compliance software are required to be verified in all zonal control modes.</p>	<p>Airflow: 150 CFM/ton</p> <p>Fan Efficacy: 0.45 W/CFM (GF) 0.58 W/CFM (non-GF)</p>	<p>Airflow: ≥ 150 CFM/ton and/or</p> <p>Fan Efficacy: ≤ 0.45 W/CFM (GF) ≤ 0.58 W/CFM (non GF)</p> <p>Verification of modeled values required in all zonal control modes.</p> <p>The <i>mandatory</i> requirements for W/cfm and CFM/ton must also be verified at highest capacity operation with all zones calling</p>
Multispeed or Variable Speed	<p>Airflow: ≥ 350 CFM/ton</p> <p>Fan Efficacy: ≤ 0.45 W/CFM (GF) ≤ 0.58 W/CFM (non-GF)</p> <p>Verification is required at highest capacity operation and with all zones calling</p>	<p>Airflow: 350 CFM/ton</p> <p>Fan Efficacy: 0.45 W/CFM (GF) 0.58 W/CFM (non-GF)</p>	<p>Airflow ≥ 350 CFM/ton and/or</p> <p>Fan Efficacy: ≤ 0.45 W/CFM (GF) ≤ 0.58 W/CFM (non-GF)</p> <p>Verification of modeled values required at highest capacity operation with all zones calling</p>

- 1 For the Prescriptive Compliance Method, all Mandatory Requirements for airflow and fan efficacy must be met and use of a bypass duct is not allowed.
- 2 For the Performance Compliance Method, all Mandatory Requirements for airflow and fan efficacy must be met and use of a bypass duct may be specified in the compliance software input for the zoned system type. Additionally, the requirements specified for performance compliance must be met
- 3 The Standard Design value for all cases is 350 CFM/ton (all system types); 0.45 W/CFM (GF); 0.58 W/CFM (non-GF).

Source: California Energy Commission

#### 4.4.1.20 Indoor Air Quality and Mechanical Ventilation

§150.0(o)

See Section 4.6 of this chapter for details.

### 4.4.2 Prescriptive Requirements for Air Distribution System Ducts, Plenums, and Fans

The 2022 Energy Code is designed to offer flexibility to the builders and designers of residential newly constructed buildings in achieving the intended energy efficiency targets. As such, several options are offered for achieving one of two design objectives related to improving energy performance of homes built with ventilated attics in Climate Zones 4, and 8-16, as shown in Figure 4-8.

**Figure 4-8: Ventilated Attic Prescriptive Compliance Choices in Climate Zones 4, 8-16**

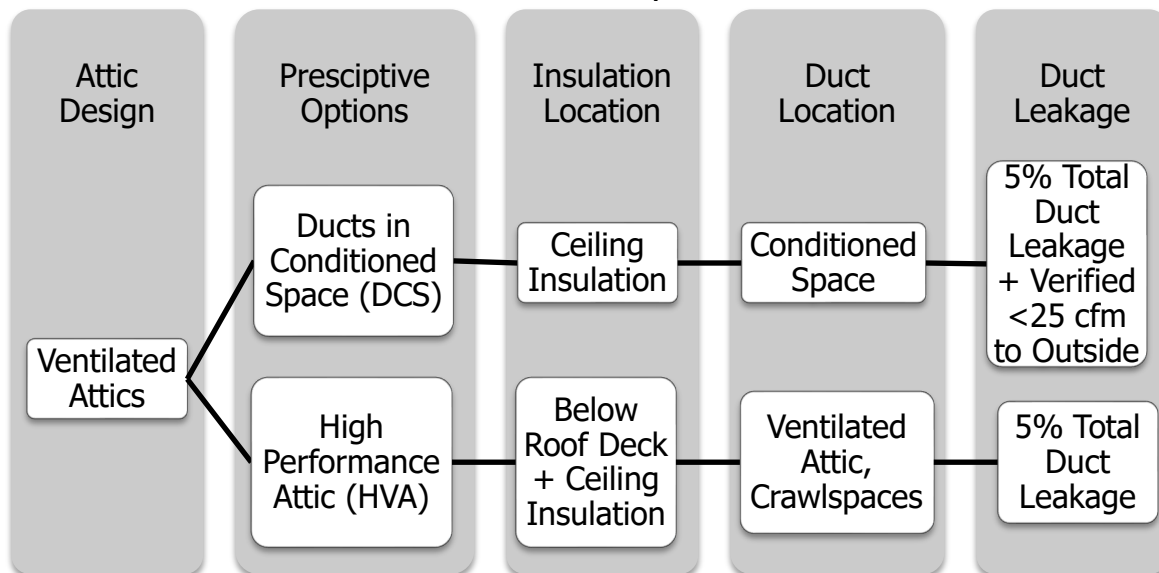

Source: California Energy Commission

A high-performance attic (HPA) implements measures that minimize temperature difference between the attic space and the conditioned air being transported

through ductwork in the attic. The package consists of insulation below the roof in addition to insulation at the ceiling, R-8 ducts, and 5 percent total duct leakage of the nominal air handler airflow. These requirements and approaches to meet the requirements are explained in Section 3.5.3 of this manual.

Ducts in conditioned space (DCS) is achieved when the ducts and air handler(s) are within the thermal envelope and air barrier of the building. This DCS option requires field verification to meet the prescriptive requirement. The following sections describe the duct related requirements for DCS.

#### 4.4.2.1 Duct Location

**§150.1(c)9**

A typical residential construction practice in California is to place ducts and associated air handling equipment in the attic. When meeting the prescriptive requirements, there are two options for where this equipment can be located:

1. If meeting the prescriptive requirements for a high-performance attic (HPA) as explained above, the duct system and air handlers of HVAC systems are allowed to be located in the attic.
2. If meeting the prescriptive requirements for ducts in conditioned space (DCS) as explained above, the duct system and air handlers of HVAC systems must be located in conditioned space, which includes a joist cavity between conditioned floors, or in a sealed cavity below attic insulation.

If the DCS requirements are to be met, additional requirements apply:

1. Air handlers containing a combustion component should be direct-vent (sealed combustion chambers) and shall not use air from conditioned space as combustion air. Other types of combustion heating systems are possible given the system installer adheres to the combustion air requirements found in Chapter 7 of the California Mechanical Code.
2. Duct location needs to be verified through a visual inspection per RA 3.1.4.1.3.
3. Duct leakage to outside needs to be confirmed by field verification and diagnostic testing in accordance with RA3.1.4.3.8.
4. Ducts are insulated to a level required in Table 150.1-A.



**Figure 4-9: Checklist for Prescriptive Requirement – Option C DCS (§ 150.1(c)1)**

<p><b>§150.1(c)1</b>  <b>Option C</b></p> <ul style="list-style-type: none"> <li><input type="checkbox"/> Vented attic</li> <li><input type="checkbox"/> R30 or R38 ceiling insulation (climate zone specific)</li> <li><input type="checkbox"/> R6 ducts (climate zone specific)</li> <li><input type="checkbox"/> Radiant Barrier</li> <li><input type="checkbox"/> Verified ducts in conditioned space</li> </ul>
--

Source: California Energy Commission

The checklist in Figure 4-9 lists all the requirements for complying prescriptively using DCS strategy. It is not enough to locate ducts in conditioned space, the insulation must also meet prescriptive values. If a building is not able to meet all of the requirements in this checklist, it must use the performance approach or Option B from Section 150.1(c).1. Refer to Section 3.5 of the *Residential Compliance Manual* for more information on these options.

There are several methods of achieving the goal of DCS. The basic information of the strategies, related benefits, challenges, and potential solutions to those challenges are outlined below.

**A. Vented Attic, Dropped Ceiling**

This strategy places ducts within the thermal envelope without affecting the standard construction of the attic space. This strategy works well in linear plans where rooms branch out from a central hallway with the dropped ceiling.

**Figure 4-10: Ducts in Conditioned Space Using a Dropped Ceiling**

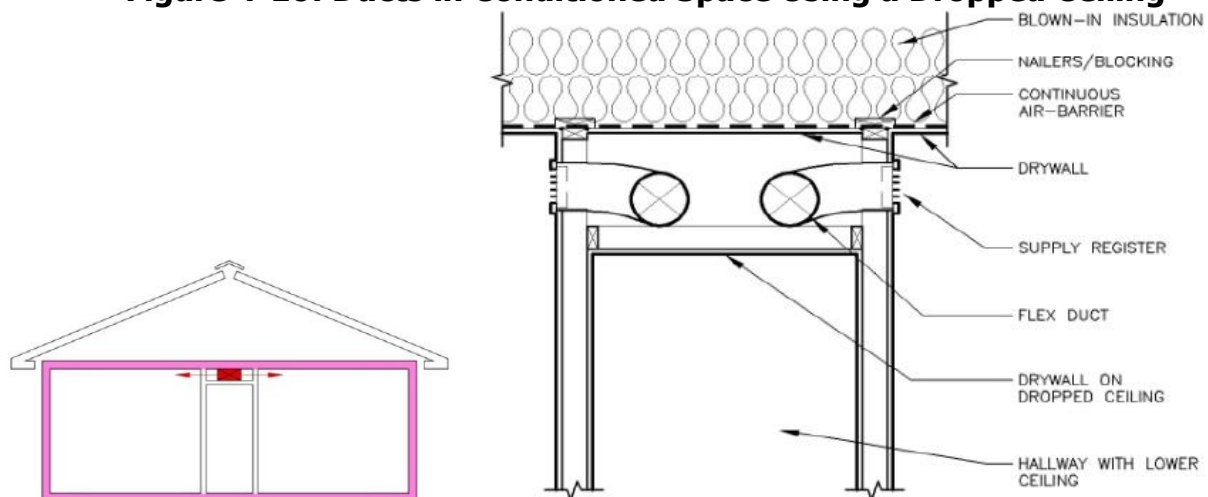

Source: www.ductsinside.org/

**Figure 4-11: Ducts Routed Through a Dropped Ceiling**



Source: BIRA Energy

Benefits of selecting this strategy include the following:

1. Attic ventilation remains the same as standard practice.
2. This strategy does not affect attic assembly or insulation; there are no changes to truss design.
3. The strategy works with simple and linear designs with rooms off the main hallway but can work with more complex plans.
4. The strategy can be integrated into architectural accents.

There are challenges associated with this strategy as outlined below, but they can be overcome with good design and installation practices.

1. Need to address air handler location – there may not be sufficient space (height, width) in the dropped ceiling to accommodate the air handler. In this case, the air handler would need to be installed in a separate closet within the thermal boundary of the home.
2. Coordination needed between trades – moving the ducts and air handlers and the need to isolate and seal the dropped ceiling would necessitate coordination between different trades (HVAC installer, drywall, framing, and electrical contractors) to ensure thermal integrity of the dropped ceiling.

## B. Vented Attic, Conditioned Plenum Space

A conditioned plenum is created when a space within the attic is sealed off and insulated from the rest of the attic. To use this design option, a builder can specify two types of modified trusses: either scissor trusses or a truss configuration that creates a plenum box. Another way to create a conditioned plenum does not involve modified trusses, but rather to create the space by framing, sealing and insulating the plenum space above the ceiling plane.

**Figure 4-12: Plenum Truss Design Example**

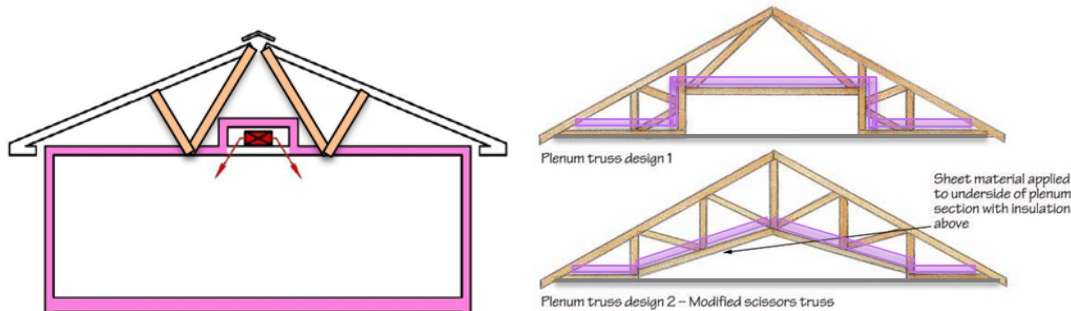

Source: [www.ductsinside.org](http://www.ductsinside.org)

Similar to a dropped ceiling, this design is easier with a linear plan that allows the conditioned space in the attic to cover a central “spine” throughout the floor plan that can reach all spaces in need of supply registers. This design option allows for ducts in the attic space and does not affect aesthetics of the home.

Benefits for selecting the strategy:

1. Vented attic space, same as standard construction
2. Aesthetically less disruptive than dropped ceiling
3. Works with simple and linear designs with rooms off main hallway

There are challenges associated with this strategy as outlined below, but they can be overcome with good design and installation practices.

1. Need to seal the plenum from attic – as with most of the DCS strategies, it is important that care and attention are provided to air-sealing the plenum space from the attic space.
2. May require modified trusses, in which case manufacturers need to be provided with specifications that can be met.

## C. Vented Attic, Open Web Floor Truss

**Figure 4-13: Open Web Floor Truss Example**

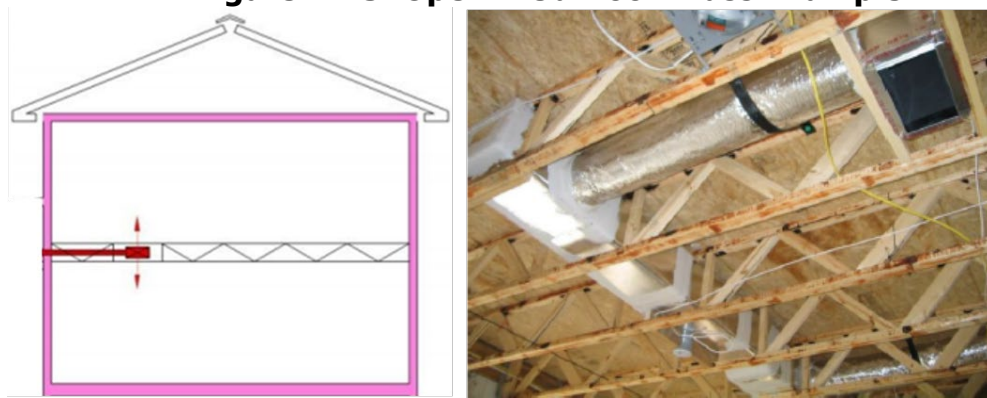

Source: [www.ductsinside.org](http://www.ductsinside.org)

This option can work for two-story construction and makes use of the space between floors to house ducts. Open-web floor trusses are uncommon in residential construction but are available from several floor joist manufacturers. The depth of floor joists may need to be increased to create a large enough space for supply ducts. The increased joist depth may affect interior details and wall heights. Because of the size constraints from using the floor truss, there is a need to preserve construction quality and prevent undesirable construction practices such as forcing 14-inch ducts into 12-inch joist spaces. Another option is to use alternatives to wire helix plastic flexible ducts that take up less space. Coordination between the architect and the HVAC engineer and/or contractor is needed to ensure that ducts are correctly sized and truss depths are appropriately selected. Using the area between floors to house ducts prescribes that supply registers be at the floor or lower wall in the second story and the ceiling or upper wall in the first story.

#### **D. Mechanical Closet and Placement of Sealed Combustion Furnace**

**Figure 4-14: Mechanical Closet Placement Example**



Source: IBACOS 2013

As part of the requirement for moving the duct system and air handler into a conditioned space, construction of a mechanical closet is necessary with some DCS strategies. For example, if ducts are placed in dropped ceiling space but there is not enough room to accommodate the air handler in that space, the mechanical closet could be placed inside the thermal boundary of the building. A conditioned plenum could provide enough space for ducts and equipment; therefore, a mechanical closet may not be needed.

One potential location for a mechanical closet is within the garage or other spaces normally not conditioned. In such instances, the air handler must be located within a specially built closet that is insulated to the same level as the exterior of the house so that the closet is not a part of the unconditioned space. Combustion air for the air handler must be taken directly from the outside through a direct vent to the outside.

#### 4.4.2.2 Duct Insulation

*§150.1(c)9*

All ducts shall be insulated to a minimum installed level as specified by Table 150.1-A, which requires either R-6 or R-8 depending on the climate zone and whether Option B or Option C is chosen for roof/ceiling Insulation. The prescriptive duct insulation requirement can be opted out by using the performance approach and trading off the energy penalty against some other features. The mandatory minimums for duct insulation are discussed in Section 4.4.1.1.

#### 4.4.2.3 Central Fan-Integrated (CFI) Ventilation

There is a prescriptive requirement for ducted systems that have cooling and a CFI ventilation system to have the fan efficacy verified. This can be opted out using the performance approach.

**Figure 4-15: R-4.2, R-6, and R-8 Ducts**

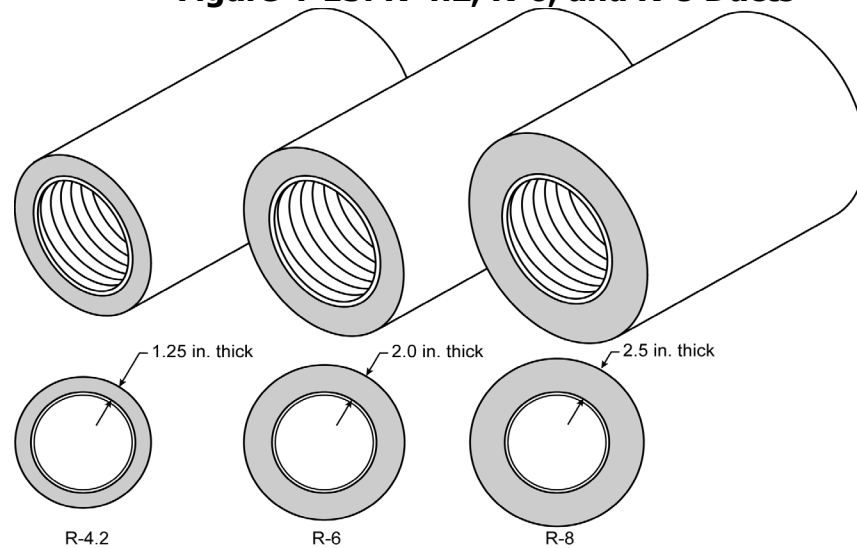

Source: California Energy Commission

#### 4.4.3 Compliance Options for Air Distribution System Ducts, Plenums, and Fans

The Energy Code provides credit for several compliance options related to duct design and construction.

##### 4.4.3.1 System Airflow and Fan Efficacy

A performance compliance credit is available for HERS verification of the installation of a high-efficiency air handler and duct system that performs better than the applicable mandatory requirements for minimum system airflow (CFM/ton) and maximum system fan efficacy (W/CFM). The performance compliance method allows the user's proposed airflow and fan efficacy to be entered into the program, and credit will be earned if the airflow is greater than the minimum required, and fan efficacy is lower than the default. After installation, the contractor must test the actual fan efficacy of each system using the procedure in RA3.3 and show that it is equal or less than what was proposed in the compliance software analysis.

The fan efficacy and airflow must also be verified by a HERS Rater.

#### 4.4.3.2 Duct Location

There are three ways to achieve credit for favorable duct location when using the performance compliance method:

1. Credit is available if no more than 12 linear feet (LF) of duct are outside the conditioned space and the user chooses the high-performance attic (HPA) as explained in Section 3.5.3. This total must include the air handler and plenum lengths. This credit results in a reduction of duct surface area in the computer compliance programs. This option requires certification by the installer and field verification by a HERS Rater.
2. The second alternative applies when 100 percent of the ducts are located in conditioned space and the user chooses high-performance attic (HPA) as explained in Section 3.5.3. This credit results in eliminating the conduction losses associated with the return and supply ducts; however, leakage rates still apply. This option requires field verification of the duct system by means of a visual inspection by a HERS Rater.
3. Credit for a high-efficiency duct design is available. This option requires field verification of the duct design layout drawing(s) by a HERS rater. Verified duct design, when required, will be included in the HERS Required Verification list on the certificate of compliance (CF1R). This approach provides energy savings credits for having shorter duct runs, fewer ducts, ducts in beneficial locations of ductwork, and other benefits of a well-designed duct system. This credit is available regardless of whether a high-performance attic (HPA) or ducts in conditioned space (DCS) option is chosen, as explained in Section 3.5.3.

There is no compliance credit provided for choosing a heating system such as a wall furnace, floor heater, or room heater, even though those systems typically have no ducts. For these cases, the standard design in the compliance calculation uses the same type of system and has no ducts. However, other systems, such as hydronic heating systems with a central heater or boiler and multiple terminal units, are considered central HVAC systems that are compared to a ducted system in the standard design. If the hydronic system has no ducts, there may be a significant energy credit through the performance method.

#### 4.4.3.3 Duct Insulation

Performance credit is also available if all the ducts are insulated to a level higher than required by the prescriptive package. If ducts with multiple R-values are installed, the lowest duct R-value must be used for the entire duct system. However, the air handler, plenum, connectors, and boots can be insulated to the mandatory minimum R-value.

As an alternative when there is a mix of duct insulation R-values, credit is available through the method described in the next section.

#### 4.4.3.4 **Diagnostic Duct Location, Surface Area, and R-value**

This compliance option allows the designer to take credit for a high-efficiency duct design that incorporates duct system features that may not meet the criteria for the duct location and/or insulation compliance options described above. This method requires that the designer must enter the design characteristics of all ducts that are not within the conditioned space. The information required for the input to the compliance software includes the length, diameter, insulation R-value, and location of all ducts. This method will result in a credit if the proposed duct system is better than the standard design.

To claim this credit, the duct system design must be documented on plans that are submitted to the enforcement agency and posted at the construction site for use by the installers, the enforcement agency field inspector, and the HERS Rater. The duct system must be installed in accordance with the approved duct system plans, and the duct system installation must be certified by the installer on the CF2R form and verified by a HERS Rater on the CF3R. Details of this compliance option are described in the *Residential Alternative Calculation Method (ACM) Reference Manual*, and verification procedures are described in RA3.1.

#### 4.4.3.5 **Buried and Deeply Buried Ducts**

This compliance option allows credit for the special case of ducts that are buried by blown attic insulation. For ducts that are within 3.5 inches of the ceiling, the effective R-value is calculated based on the duct size and R-value, depth of ceiling insulation, and type of blown insulation (fiberglass or cellulose) as shown in Tables 16, 17, and 18 in the *Residential ACM Reference Manual*. The user-entered duct system can be any combination of unburied, buried, and deeply buried duct runs. The software will determine the overall duct system effective R-value by weight averaging the user entered duct system.

Ducts must have a minimum insulation level prior to burial, R-6 for new ducts and R-4.2 for existing. This case is referred to as "Buried Ducts on the Ceiling." Additional credit is available for "Deeply Buried Ducts," which, in addition to the requirements for "Buried Ducts on the Ceiling," are ducts completely covered by at least 3.5 inches of attic insulation. Deeply buried ducts must be enclosed in a lowered portion of the ceiling or buried by use of a durable containment system (e.g. gypsum board, plywood, etc.), or buried under a uniform level of insulation that achieves the 3.5-inch burial level.



**Figure 4-16: Buried Ducts on Ceiling and Deeply Buried Ducts**

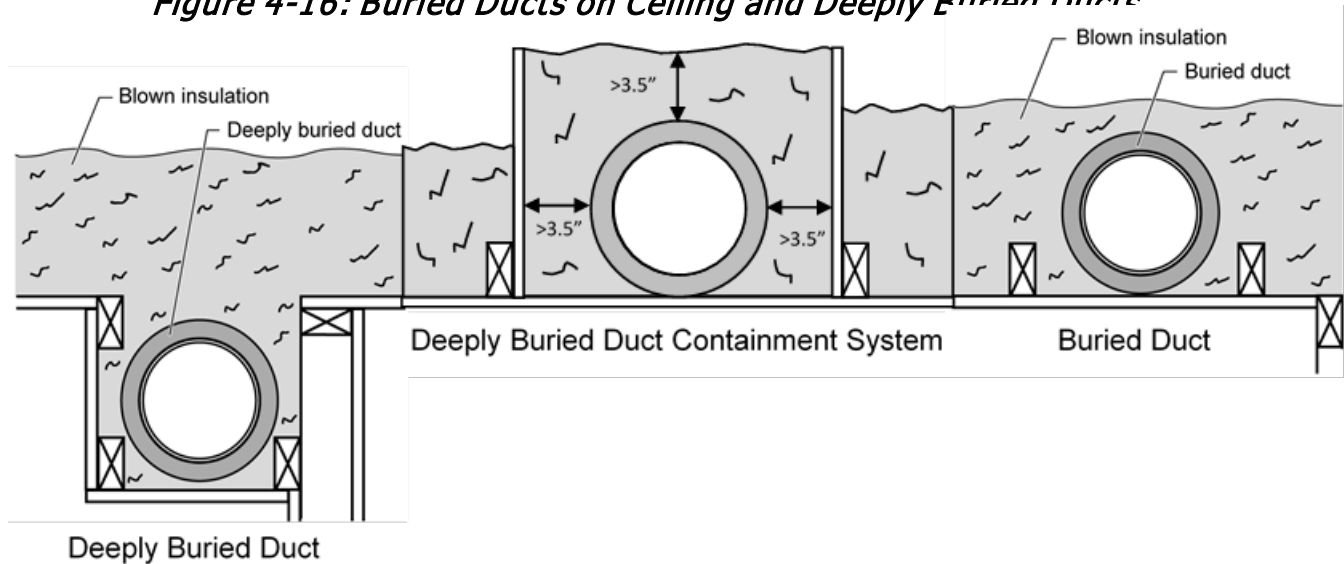

Source: California Energy Commission

Deeply buried containment systems must be installed such that the walls of the system are at least 7 inches wider than the duct diameter (3.5-inch clearance on each side of duct) extend at least 3.5 inches above the duct outer jacket, and the containment area surrounding the duct must be completely filled with blown insulation.

In addition to the above requirements, the attic area containing the buried or deeply buried ducts must have insulation with uniform depth (not mounded over the duct), level ceiling, and at least 6 inches of space between the duct outer jacket and the roof sheathing. Insulation raised by a containment system is an exception to the uniform depth requirement.

To take credit for buried ducts, the system must meet the verified duct system design criteria described above and meet the requirements for Quality Insulation Installation (QII) described in Reference Appendices RA3.5.

#### 4.4.3.6 Ducts in Attics with Radiant Barriers

Installation of a radiant barrier in the attic increases the duct efficiency by lowering attic summer temperatures. Compliance credit for radiant barriers is available in cases where the prescriptive standard does not require radiant barriers and requires listing of the radiant barrier in the special features and modeling assumptions to aid the local enforcement agency's inspections. Compliance credit for a radiant barrier does not require HERS Rater verification.

Radiant barrier must be installed with the appropriate clearance and/or air gap as specified by the manufacturer. Insulation products installed in direct contact with the radiant barrier may negatively affect the performance of the radiant barrier. When a

credit is taken for radiant barrier, an improperly installed radiant barrier assembly will require revision of the CF1R compliance document to remove the energy compliance credit taken.

#### 4.4.4 Duct Installation Standards

The mandatory duct construction measures referenced in Section 4.4.1 above state that duct installations must comply with the California Mechanical Code Sections 601, 602, 603, 604, 605, and the applicable requirements of the Energy Code. Some highlights of these requirements are listed in this section, along with some guidance for recommended quality construction practice.

##### 4.4.4.1 Tapes and Clamps

All tapes and clamps must meet the requirements of §150.0(m).

Cloth-backed, rubber-adhesive tapes must be used only in combination with mastic and draw bands or have on the backing the phrase "CEC approved," a drawing of a fitting to plenum joint in a red circle with a slash through it (the international symbol of prohibition), and a statement that it cannot be used to seal fittings to plenums and junction box joints.

##### 4.4.4.2 All Joints Must Be Mechanically Fastened

For residential round metal ducts, installers must overlap the joint by at least 1½ inches and use three sheet metal screws equally spaced around the joint. (See Figure 4-17.)

**Figure 4-17: Connecting Round Metallic Ducts**

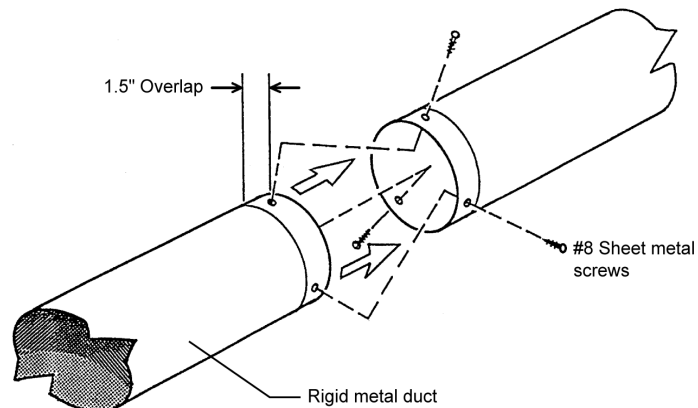

Source: Richard Heath & Associates/Pacific Gas and Electric Company

For round, nonmetallic flex ducts, installers must insert the core over the metal collar or fitting by at least 1 inch. This connection may be completed with either mesh, mastic and a clamp, or two wraps of tape and a clamp.

For a mesh and mastic connection, the installer must first tighten the clamp over the overlapping section of the core, apply a coat of mastic covering both the metal collar and the core by at least 1 inch, and then firmly press the fiber mesh into the mastic and cover with a second coat of mastic over the fiber mesh. (See Figure 4-18.)

**Figure 4-18: Connecting Flex Ducts Using Mastic and Mesh**

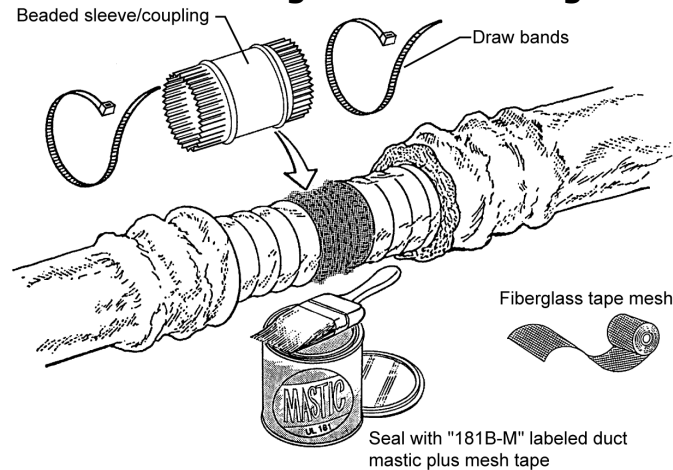

Source: Richard Heath & Associates/Pacific Gas and Electric Company

For the tape connection first apply at least two wraps of approved tape covering both the core and the metal collar by at least 1 inch; then tighten the clamp over the overlapping section of the core. (See Figure 4-19.)

**Figure 4-19: Connecting Flex Ducts Using Tape and Clamps**

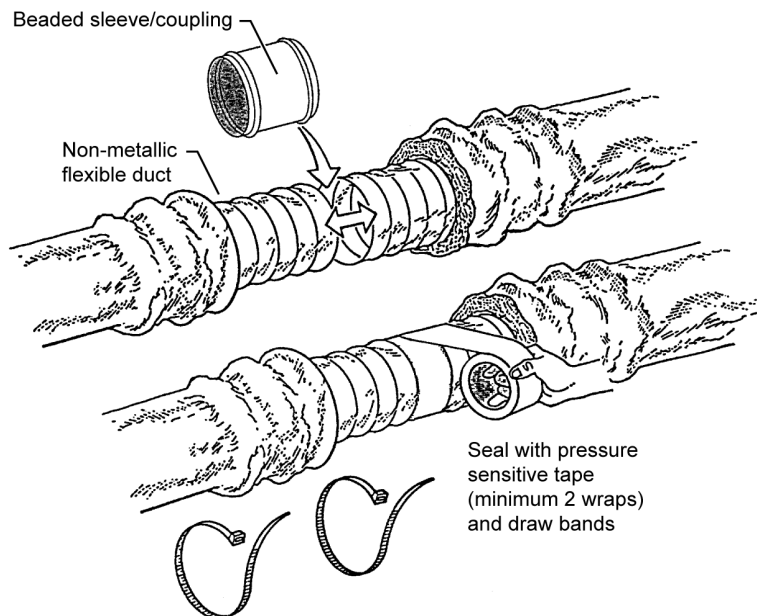

Source: Richard Heath & Associates/Pacific Gas and Electric Company

#### 4.4.4.3 All Joints Must Be Made Airtight

§150(m)

Seal all joints with either mastic, tape, aerosol sealant, or other duct-closure system that meets the applicable requirements of UL 181, UL 181A, UL 181B, or UL 723. Duct systems shall not use cloth-backed, rubber-adhesive duct tape regardless of UL designation, unless it is installed in combination with mastic and clamps. The Energy Commission has approved three cloth-backed duct tapes with special butyl synthetic adhesives rather than rubber adhesive to seal flex duct to fittings. These tapes are:

1. Polyken® 558CA, manufactured by Berry Plastics Tapes and Coatings Division.
2. Nashua® 558CA, manufactured by Berry Plastics Tapes and Coatings Division.
3. Shurtape® PC 858CA, manufactured by Shurtape Technologies, Inc.

These tapes passed Lawrence Berkeley Laboratory tests comparable to those that cloth-backed, rubber-adhesive duct tapes failed. (The LBNL test procedure has been adopted by the American Society of Testing and Materials as ASTM E2342.) These tapes are allowed to be used to seal flex duct to fittings without being in combination with mastic. These tapes cannot be used to seal other duct system joints, such as the attachment of fittings to plenums and junction boxes. These tapes have on the backing a drawing of a fitting to plenum joint in a red circle with a slash through it (the international symbol of prohibition) to illustrate where they are not allowed to be used, installation instructions in the packing boxes that explain how to install them on duct core to fittings, and a statement that the tapes cannot be used to seal fitting to plenum and junction box joints.

Mastic and mesh should be used where round or oval ducts join flat or round plenums. (See Figure 4-20.)

**Figure 4-20: Sealing Metallic Ducts with Mastic and Mesh**

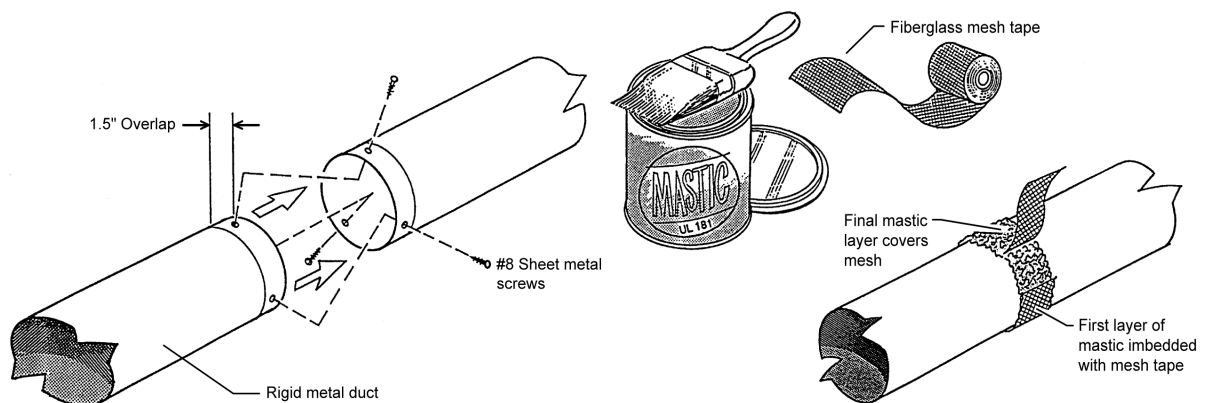

Source: Richard Heath & Associates/Pacific Gas and Electric Company

All ducts must be adequately supported.

Rigid ducts and flex ducts may be supported on rigid building materials between ceiling joists or on ceiling joists.

For rigid round metal ducts that are suspended from above, hangers must occur 12 ft. apart or less. (See Figure 4-21)

**Figure 4-21: Options for Suspending Rigid Round Metal Ducts**

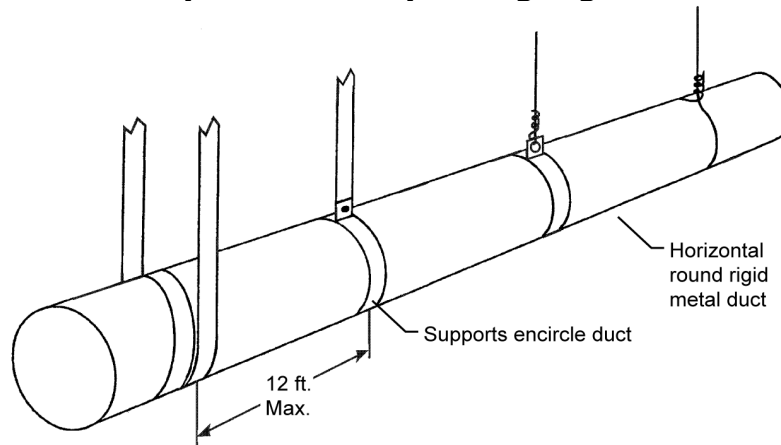

Source: Richard Heath & Associates/Pacific Gas and Electric Company

For rectangular metal ducts that are suspended from above, hangers must occur at a minimum of 4 ft. to 10 ft., depending on the size of the ducts. (See Table 6-2A in Appendix A of the California Mechanical Code and refer to Figure 4-22.)

**Figure 4-22: Options for Suspending Rectangular Metal Ducts**

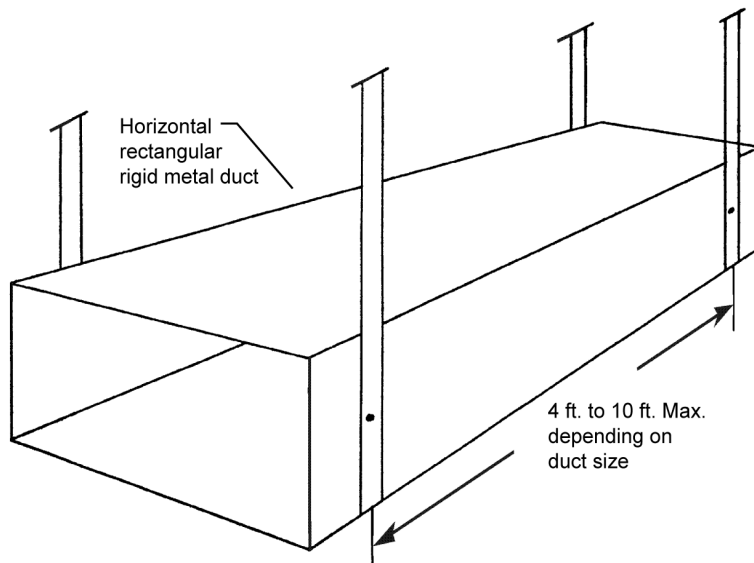

Source: Richard Heath & Associates/Pacific Gas and Electric Company

For flex ducts that are suspended from above, hangers must occur at 4 ft. apart or less, and all fittings and accessories must be supported separately by hangers. (See Figure 4-23.)

**Figure 4-23: Minimum Spacing for Suspended Flex Ducts**

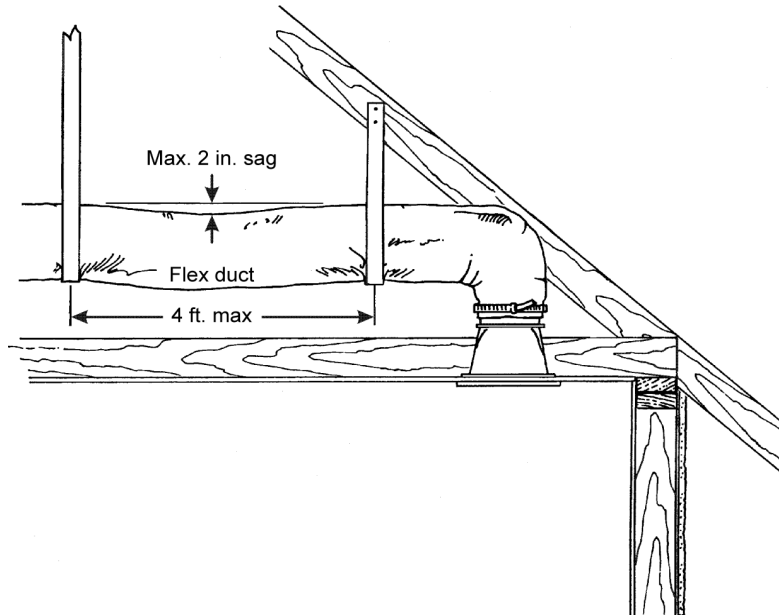

Source: Richard Heath & Associates/Pacific Gas and Electric Company

For vertical runs of flex duct, support must occur at 6 ft. intervals or less. (See Figure 4-24)

**Figure 4-24: Minimum Spacing for Supporting Vertical Flex Ducts**

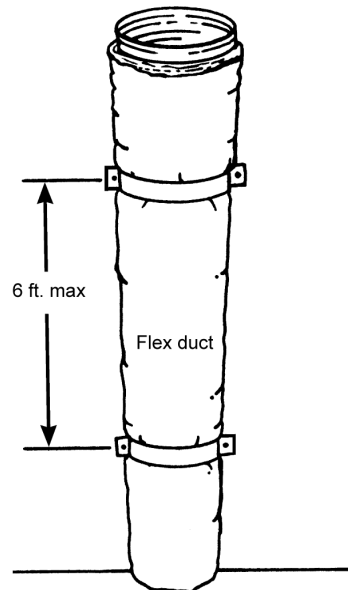

Source: Richard Heath & Associates/Pacific Gas and Electric Company

The routing and length of all duct systems can have significant effects on system performance due to possible increased airflow resistance. The Energy Commission recommends using the minimum length of duct to make connections and the minimum possible number of turns.

For flexible ducts, the Energy Commission recommends fully extending the duct by pulling the duct tightly, cutting off any excess duct, and avoiding bending ducts across sharp corners or compressing them to fit between framing members. (See Figure 4-25) Also avoid incidental contact with metal fixtures, pipes, or conduits or installation of the duct near hot equipment such as furnaces, boilers, or steam pipes that are above the recommended flexible duct use temperature.

**Figure 4-25: Minimizing Radius for Flex Duct Bends**

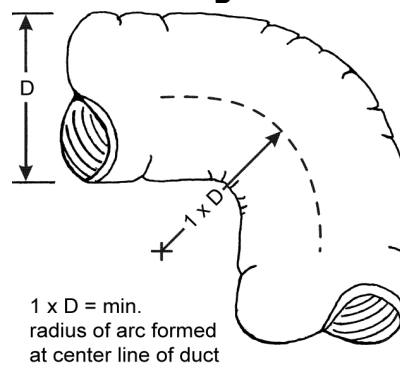

Source: Richard Heath & Associates/Pacific Gas and Electric Company

All joints between two sections of duct must be mechanically fastened and substantially airtight. For a flex duct, this must consist of a metal sleeve no less than 4 inches between the two sections of flex duct.

All joints must be properly insulated. For flex ducts, installers must pull the insulation and jacket back over the joint and use a clamp or two wraps of tape. Aerosol sealant injection systems are an alternative that typically combines duct testing and duct sealing in one process.

Figure 4-26 shows the computer-controlled injection fan temporarily connected to the supply duct. The plenum is blocked off by sheet metal to prevent the sealant from entering the furnace. Supply air registers are also blocked temporarily to keep the sealant out of the house. Ducts must still be mechanically fastened even if an aerosol sealant system is used.

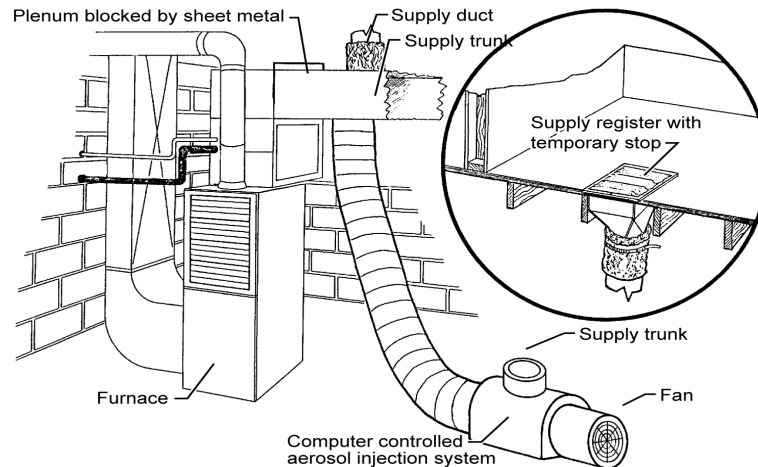
**Figure 4-26: Computer-Controlled Aerosol Injection System**

Source: Richard Heath & Associates/Pacific Gas and Electric Company

## 4.5 Controls

### 4.5.1 Thermostats

Automatic setback thermostats can add comfort and convenience to a home. Occupants can wake up to a warm house in the winter and come home to a cool house in the summer without using unnecessary energy.

*§110.2 (b) & (c), §150.0(i)*

A thermostat is always required for central systems whether the prescriptive or performance compliance method is used. An exception is allowed only if the system is one of the following non-central types:

1. Non-central electric heaters.
2. Room air conditioners.
3. Room air conditioner heat pumps.
4. Gravity gas wall heaters.
5. Gravity floor heaters.
6. Gravity room heaters.
7. Wood stoves.
8. Fireplace or decorative gas appliances.

When it is required, the setback thermostat must have a clock or other mechanism that allows the building occupant to schedule the heating and/or cooling set points for at least four periods over 24 hours.



Thermostats for heat pumps must be “smart thermostats” that minimize the use of supplementary electric resistance heating during startup and recovery from setback, as discussed earlier in the heating equipment section.

Example 4-6

**Question:**

Am I exempt from the requirement for a thermostat if I have a gravity wall heater or any of the equipment types listed in the exception to §110.2(c)?

**Answer:**

Yes.

**4.5.2 Zonal Control for Compliance Credit**

An energy compliance credit is provided for zoned heating systems, which save energy by providing selective conditioning for only the occupied areas of a house. A house having at least two zones (living and sleeping) may qualify for this compliance credit. The equipment may consist of one heating system for the living areas and another system for sleeping areas or a single system with zoning capabilities, set to turn off the sleeping areas in the daytime and the living area unit at night. (See Figure 4-27)

**Figure 4-27: Zonal Control Example**

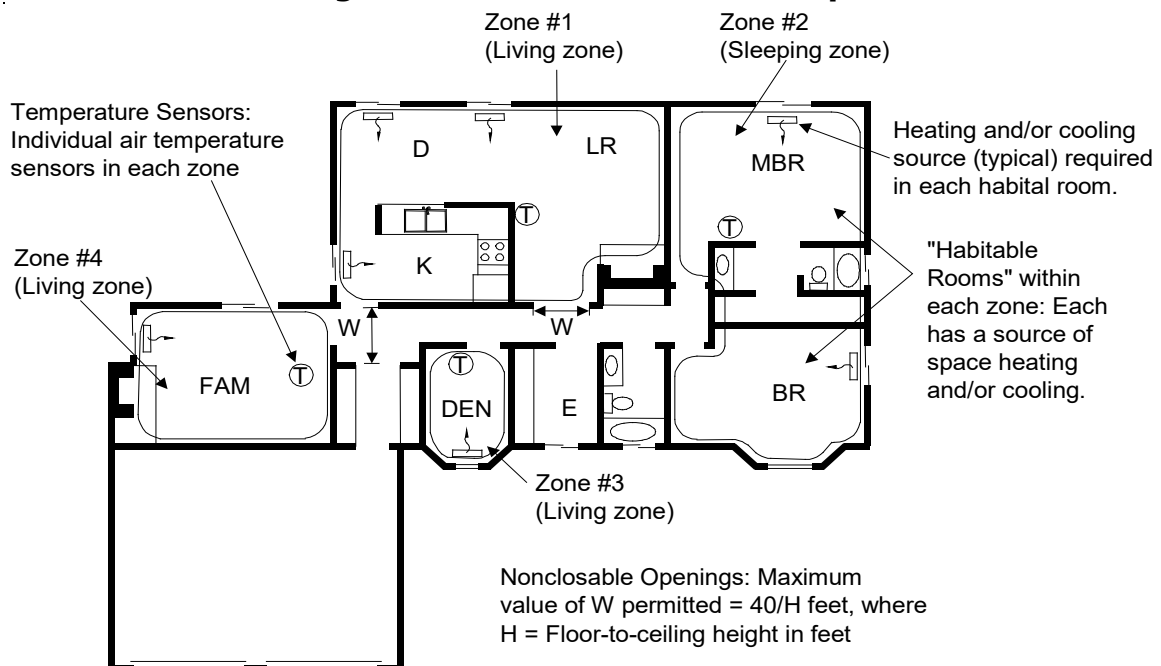

Source: Richard Heath & Associates/Pacific Gas and Electric Company

There are unique eligibility and installation requirements for zonal control to qualify under the Energy Code. The following steps must be taken for the building to show compliance with the Energy Code under this exceptional method:

1. **Temperature Sensors.** Each thermal zone, including a living zone and a sleeping zone, must have air temperature sensors that provide accurate temperature readings of the typical condition in that zone.
2. **Habitable Rooms.** For systems using central forced-air or hydronic heating, each habitable room in each zone must have a source of space heating, such as forced-air supply registers, radiant tubing, or a radiator. For systems using a combination of a central system and a gas-vented fireplace or other conditioning units, the zone served by the individual conditioning unit can be limited to a single room. Bathrooms, laundry, halls and/or dressing rooms are not habitable rooms.
3. **Noncloseable Openings.** The total noncloseable opening area (W) between adjacent living and sleeping thermal zones (such as halls, stairwells, and other openings) must be less than or equal to 40 ft<sup>2</sup>. All remaining zonal boundary areas must be separated by permanent floor-to-ceiling walls and/or fully solid, operable doors capable of restricting free air movement when closed.
4. **Thermostats.** Each zone must be controlled by a central automatic dual-setback thermostat that can control the conditioning equipment and maintain preset temperatures for varying periods in each zone independent of the other. Thermostats controlling vented gas fireplace heaters that are not permanently mounted to a wall are acceptable as long as they have the dual-setback capabilities.

Other requirements specific to forced-air-ducted systems include the following:

1. Each zone must be served by a return air register located entirely within the zone. Return air dampers are not required.
2. Supply air dampers must be manufactured and installed so that when they are closed, there is no measurable airflow at the registers.
3. The system must be designed to operate within the equipment manufacturer's specifications.
4. Air is to positively flow into, though, and out of a zone only when the zone is being conditioned. No measurable amount of supply air is to be discharged into unconditioned or unoccupied space to maintain proper airflow in the system.

Although multiple thermally distinct living and/or sleeping zones may exist in a residence, the correct way to model zonal control for credit requires only two zones: a living zone and a sleeping zone. All separate living zone components must be modeled as one living zone; the same must be done for sleeping zones.

## Example 4-7

**Question:**

In defining the living and sleeping zones for a home with a zonally controlled HVAC system, can laundry rooms and bathrooms (which are not habitable spaces) be included on whichever zone they are most suited to geographically (for example, a bathroom located near bedrooms)?

**Answer:**

Yes. For computer modeling, include the square footage of any not habitable or indirectly conditioned spaces with the closest zone.

## Example 4-8

**Question:**

I have two HVAC systems and want to take zonal control credit. Can the return air grilles for both zones be located next to each other in the 5 ft. wide by 9 ft. high hallway (in the same zone)?

**Answer:**

No. Because of the need to prevent mixing of air between the conditioned zone and the unconditioned zone, it is necessary to (1) have the return air for each zone within that zone, and (2) limit any noncloseable openings between the two zones to 40 ft<sup>2</sup> or less. Unless these criteria and the other criteria listed in this chapter can be met, credit for a zonally controlled system cannot be taken.

## Example 4-9

**Question:**

Can a gas-vented fireplace be used for zonal control heating, and qualify for the zonal control credit?

---

**Answer:**

Gas-vented fireplaces that meet zonal control requirements may qualify for the zonal control credit.

## Example 4-10

**Question:**

Does a gas-vented fireplace with a handheld remote thermostat meet the thermostat requirement for the two-zone modeling credit?

**Answer:**

---

Yes, as long as the thermostat has manual “on” to start, automatic setback capability, and temperature preset capability, it does not have to be permanently wall-mounted.

---

## 4.6 Indoor Air Quality and Mechanical Ventilation

*§150.0(o), §150.2(a)1C, and §150.2(a)2C*

This section provides basic concepts and context to help navigate the mandatory requirements for exhaust fans in bathrooms and kitchens, and continuous low-cfm indoor-outdoor (I-O) air exchange in single-family homes.

The Energy Code requirement for mechanical ventilation of homes is a health and safety priority, not a building energy efficiency measure. Efficient homes are more airtight for comfort and efficiency, which makes it both easier and more important to use a small I-O fan to control air exchange.

Because mechanical ventilation is a continuous electrical end use in homes, energy efficiency is a factor to consider when selecting a ventilation system. Other factors include quiet operation, outdoor air filtration, and indoor air distribution. The Energy Code sets minimum standards for airflow, noise, ducting, and controls.

Unlike central forced-air space conditioning systems that heat, cool, mix and recirculate indoor air to maintain comfort, the purpose of continuous mechanical ventilation is to ensure adequate I-O air exchange whenever windows are closed.

Central space conditioning systems use supply and return ductwork to move large amounts of air (over 1,000 cfm) as needed in response to a thermostat. Whole-dwelling mechanical ventilation systems use smaller (about 100 cfm) fans to continually exchange air through supply and/or exhaust ventilation ductwork.

Residential mechanical ventilation is a means to another end, which is acceptable indoor air quality (IAQ) for occupants. Energy Code-compliant ventilation systems can be expected to control the common types and levels of residential indoor air pollutants—moisture, odors, and volatile organic chemicals (VOCs). However, they cannot protect occupants from tobacco smoke or other high-polluting events that create excess moisture, odors, or VOCs in the home. In other words, because they cannot account for all the variables of occupant lifestyle and behavior, these ventilation systems do not guarantee good IAQ.

When possible, indoor air pollutants should be controlled at their source. That is the purpose of exhaust fans in bathrooms and kitchens, which occupants operate as needed. Also called local exhaust fans or spot fans, they are the best way to eliminate excess indoor moisture – operable windows are no longer sufficient.

### 4.6.1 Continuous Mechanical Ventilation for Indoor Air Quality

ASHRAE *Standard 62.2–Ventilation for Acceptable Indoor Air Quality in Residential Buildings* recognizes the need for controlled mechanical outdoor air supply in homes that are built tight for efficient space conditioning. Infiltration, or uncontrolled air leakage through the building, is highest during winter and lowest in mild weather, and too inconsistent to rely on for air exchange.

California’s 2008 Energy Code adopted Standard 62.2-2007 with exceptions, and the 2013 Energy Code began requiring HERS field verification of airflow rates of residential I-O ventilation systems installed to meet this requirement. 2022 Energy Code incorporate updated versions of Standard 62.2 and extend its requirements to multifamily and high-rise residential buildings.

Standard 62.2 requires two residential mechanical ventilation functions:

- Local exhaust fans in bathrooms and kitchens to remove most occupant-generated moisture and odors where and when they are generated.
- Whole-dwelling ventilation systems to automatically ensure an adequate amount of I-O air exchange year-round, regardless of window operation.

It also discusses the need for tightening building envelopes and preventing habitable spaces from drawing air from polluted spaces such as garages, attics, crawlspaces, adjacent dwellings, and other sources of outdoor air pollution.

Since the Energy Code requirement for mechanical ventilation is a continuous electrical end use in new homes, fan efficacy (in W/cfm fan flow) is one factor to consider when selecting a ventilation system.

### 4.6.2 Types of Mechanical Ventilation Systems

There are three basic ways to meet the whole-dwelling ventilation requirement.

- Exhaust-only systems remove indoor air and create some degree of negative indoor pressure (depressurization) that induces air infiltration of the building envelope through the paths of least resistance.
- Supply-only systems filter outdoor air from a known location before delivering it to a home; this creates some degree of positive pressure (pressurization) that can serve to both prevent infiltration and buffer against depressurization.
- Balanced ventilation systems use an exhaust fan and a supply fan that move approximately the same amount of air at the same time; these opposite airflows have little effect on indoor pressure, and cannot prevent the forces of wind, stack effect, and other fans from pressurizing or depressurizing a home.

Indoor pressures cannot be avoided. In fact, the tighter and more energy-efficient the building envelope, the higher indoor pressures can and will be. Airflow requires both a driving force and a pathway. Regardless of the degree of indoor pressure, infiltration cannot occur unless there are leakage sites or designated pathways for air to flow.

The building science principle “Build Tight, Ventilate Right” acknowledges that energy efficient homes require tight building envelopes that make it possible for a continuous low-cfm ventilation system to control indoor-outdoor air exchange.

Balanced systems do not create indoor pressure or neutralize indoor pressure. The advantage of a balanced mechanical ventilation system is the ability to incorporate an engineered heat exchanger core that passively transfers thermal energy between the outgoing exhaust airstream and incoming supply airstream. This reduces the cost of heating and cooling the incoming supply ventilation air. However, balanced heat or energy recovery ventilation (HRV, ERV) systems cannot recover heat from air that infiltrates the home and bypasses the system’s core.

The remainder of this section describes minimum requirements for residential mechanical ventilation, which can be readily exceeded or improved upon by:

- Using local exhaust fans as needed to remove moisture and odors.
- Using source control to minimize air pollutants within the building.
- Operating the whole-dwelling fan continuously to minimize VOC levels.

As residential buildings are tightened to improve energy performance, the dilution of indoor air through natural ventilation and infiltration has been reduced. As a result, the importance of controlling indoor pollutants and moisture generated and volatile organic compounds (VOCs) in homes has increased.

Energy Commission sponsored field research revealed that indoor concentrations of pollutants such as formaldehyde are higher than expected, and that many occupants do not open windows regularly for ventilation.

The Energy Code includes mandatory requirements for local mechanical exhaust and whole-dwelling unit mechanical ventilation to improve indoor air quality (IAQ) in homes and MERV 13 air filtration requirements for ventilation systems. As specified by §150.0(o), dwelling units must meet the requirements of ASHRAE Standard 62.2-2019 including Addenda v and d (ASHRAE 62.2), subject to the amendments specified in Section 150.0(o)1. A [copy of this version of ASHRAE 62.2](https://www.techstreet.com/ashrae/standards/ashrae-62-2-2019?product_id=2087691) may be obtained at the following URL:

[https://www.techstreet.com/ashrae/standards/ashrae-62-2-2019?product\\_id=2087691](https://www.techstreet.com/ashrae/standards/ashrae-62-2-2019?product_id=2087691)

Opening and closing windows and continuous operation of central fan-integrated ventilation systems are not allowable options for meeting dwelling unit ventilation

requirements. The requirements of ASHRAE Standard 62.2 focus on providing continuous dwelling unit mechanical ventilation, as well as local exhaust ventilation at known sources of pollutants or moisture, such as kitchens, bathrooms, and laundries. The California Air Resources Board (CARB) provides guidance for reducing indoor air pollution in homes by selecting low-VOC building materials, finishes, and furnishings. For more information, see the [CARB Indoor Air Quality Guidelines](http://www.arb.ca.gov/research/indoor/guidelines.htm):

<http://www.arb.ca.gov/research/indoor/guidelines.htm>

This section covers mandatory requirements for mechanical ventilation of homes, the process of compliance and enforcement, including HERS verifications, and requirements specified by ASHRAE 62.2 as amended in the Energy Code. Compliance with the whole-dwelling unit ventilation airflow specified in ASHRAE 62.2 is required in new dwelling units, in new dwelling units that are additions to an existing building except for junior accessory dwelling units, and in additions to existing dwelling units that increase the conditioned floor area of the existing dwelling unit by more than 1,000 square feet. Alterations to components of existing buildings that previously met any requirements of ASHRAE 62.2 must continue to meet requirements upon completion of the alteration(s).

The key requirements for most newly constructed buildings are summarized below:

1. A whole-dwelling unit mechanical ventilation system shall be provided. Typical solutions are described in Section 4.6.4 below. The airflow rate provided by the system shall be confirmed through field verification and diagnostic testing in accordance with the applicable procedures specified in RA3.7.
2. Kitchens and bathrooms must have local exhaust systems vented to outdoors.
3. Clothes dryer exhaust shall be vented to outdoors.

Additional indoor air quality design requirements include:

1. Ventilation air shall come from outdoors and shall not be transferred from adjacent dwelling units, garages, unconditioned attics, or crawl spaces.
2. Ventilation system controls shall be labeled, and the homeowner shall be provided with instructions on how to operate the system.
3. Combustion appliances shall be properly vented to outdoors and exhaust systems shall be designed to prevent back drafting.
4. Walls and openings between the house and attached garage shall be sealed or gasketed to prevent air exchange between the house and garage.
5. Habitable rooms shall have operable windows with a free opening area of at least 4 percent of the floor area.

6. Mechanical systems including space conditioning systems that supply air to habitable spaces shall have a MERV 13 or better filter and be designed to accommodate the air filter's rated pressure drop at the designed airflow rate.
7. Dedicated outdoor air inlets that are part of the ventilation system design shall be located away from known sources of outdoor contaminants.
8. A carbon monoxide alarm shall be installed in each dwelling unit in accordance with NFPA Standard 720.
9. Air-moving equipment used to meet the whole-dwelling unit ventilation requirement and local exhaust requirement shall be rated for airflow and sound:
  - a. Whole-dwelling unit ventilation and continuously operating local exhaust fans must be rated at a maximum of 1.0 sone.
  - b. Demand-controlled local exhaust fans must be rated at a maximum of 3.0 sones.
  - c. Kitchen exhaust fans must be rated at a maximum of 3.0 sones at one or more airflow settings greater than or equal to 100 CFM.
  - d. Remotely located air-moving equipment (mounted outside habitable spaces) are exempt from the sound requirements provided there is at least 4 feet of ductwork between the remote fan and interior grille.

#### **4.6.3 Compliance and Enforcement**

Compliance with ASHRAE 62.2 requirements must be verified by the enforcement agency, except for the following requirements that must be HERS verified in accordance with the procedures in Residential Appendix RA3.7:

- Whole-dwelling unit ventilation airflow rate
- HVI or AHAM ratings for kitchen local mechanical exhaust fan airflow or capture efficiency, and sound.

All applicable certificates of compliance, installation, and verification must be registered with an approved HERS Provider.

Title 24 Part 6 amendments to ASHRAE 62.2 do not require a blower door measurement when calculating the dwelling unit mechanical ventilation rate ( $Q_{fan}$ ). Instead, the  $Q_{fan}$  calculation applies a default infiltration leakage rate of 2 ACH<sub>50</sub> (air changes per hour at 50 Pascals). Blower door measurement of actual dwelling unit enclosure leakage is required only when performance compliance modeling uses an infiltration leakage rate less than 2 ACH<sub>50</sub> - which requires HERS verification of enclosure leakage for energy compliance and for determining  $Q_{fan}$ .



If a central heating/cooling system air-handler fan is used to ventilate the dwelling (central fan-integrated ventilation, also known as CFI ventilation), the air-handler must be less than or equal to the mandatory fan efficacy criteria. This requires the installer to perform the test given in Reference Appendix RA3.3 and a HERS Rater to verify the efficacy (W/CFM) of the central air-handler fan.

#### 4.6.3.1 Certificate of Compliance Reporting Requirements

When using the prescriptive compliance approach, the mechanical ventilation rate ( $Q_{fan}$ ) must be calculated using the applicable equations in Energy Code Section 150.0(o)1, also shown in Section 4.6.4 below. The value for  $Q_{fan}$  must be reported on the CF1R. When using the performance compliance approach, the compliance model automatically calculates  $Q_{fan}$  based on inputs for conditioned floor area, number of bedrooms, and climate zone (Table 4-14), and uses the  $Q_{fan}$  ventilation airflow value when calculating the building energy use. The performance certificate of compliance (CF1R-PRF-01) will report the following parameters for the whole-dwelling unit ventilation system:

1. Minimum mechanical ventilation airflow rate (calculated value) that must be delivered by the system.
2. Type of ventilation system (exhaust, supply, balanced, CFI).
3. Fan efficacy (W/CFM) for the selected system.
4. Recovery efficiency (%) applicable only to HRV or ERV systems
5. For CFI systems--HERS verification of air handler fan efficacy is required.

The installed dwelling unit ventilation system must conform to the performance requirements on the CF1R.

The local enforcement agency may require additional information/documentation describing the ventilation systems be submitted along with the CF1R at plan check.

#### 4.6.3.2 Certificates of Installation and Verification Reporting Requirements

The builder/installer must complete two certificates of installation (CF2R-MCH-27 and CF2R-MCH-32) for the dwelling. The HERS Rater must complete a certificate of verification (CF3R-MCH-27) for the dwelling.

##### 4.6.3.2.1 CF2R-MCH-27

The following information must be provided on the CF2R-MCH-01 for each ventilation fan/system in the dwelling that will require HERS verification.

For dwelling unit ventilation systems:

1. System type, name, and location

2. Control type
3. Minimum required continuous airflow rate
4. Ventilation fan or system manufacturer, and model number
5. Energy Commission certification number for variable system/control (if any)

For kitchen exhaust ventilation systems:

1. Type of exhaust fan control (intermittent, demand-controlled, or continuous)
2. Type of exhaust fan (range hood, over-the-range microwave, downdraft, other).
3. Required airflow or capture efficiency.
4. Manufacturer name and model number.

#### 4.6.3.2.2 **CF2R-MCH-32**

The following additional information must be provided on the CF2R-MCH-32 to document compliance with §150.0(o). Refer also to the procedures in RA 3.7.4.

For dwelling unit ventilation systems:

- Measured airflow rate of the installed dwelling unit ventilation system. For balanced systems, both exhaust and supply airflows must be measured and recorded; system airflow rate is the average (not the sum) of exhaust and supply airflows.

For kitchen exhaust ventilation systems:

- Confirmation that the installed system is rated by HVI or AHAM to meet the required airflow or capture efficiency, and sound requirements.

For all ventilation systems:

- Confirmation that the other applicable requirements given in Sections 6 and 7 of ASHRAE 62.2 as amended in 150.0(o)1 have been met (see Sections 4.6.7 and 4.6.8 below).

#### 4.6.3.2.3 **CF3R-MCH-27**

The following additional information must be provided on the CF3R-MCH-27 to document compliance with §150.0(o):

For dwelling unit ventilation systems:

- Measured airflow rate of the installed dwelling unit ventilation system. For balanced systems, both exhaust and supply airflows must be measured and recorded.

For kitchen exhaust ventilation systems:

- Confirmation the installed system is rated to meet the required airflow and sound requirements.

#### 4.6.4 Typical Solutions for Single-Family Dwelling Unit Ventilation

From ASHRAE 62.2, Section 4.2, System Type.

The dwelling-unit mechanical ventilation system shall consist of one or more supply or exhaust fans and associated ducts and controls. Local exhaust fans shall be permitted to be part of a mechanical exhaust system. Where local exhaust fans are used to provide dwelling-unit ventilation, the local exhaust airflow may be credited toward the dwelling-unit ventilation airflow requirement. Outdoor air ducts connected to the return side of an air handler shall be permitted as supply ventilation if manufacturers' requirements for return air temperature are met.

There are four basic strategies for meeting the whole-dwelling unit air ventilation requirement:

1. Exhaust ventilation – indoor air is exhausted from the dwelling and replaced by infiltration.
2. Supply ventilation - outdoor air is filtered before being supplied directly to the dwelling unit.
3. Central fan-integrated (CFI) ventilation – a ventilation system configuration in which the ventilation ductwork is connected to the duct system of the space conditioning system to enable distribution of ventilation air to the dwelling unit while the space conditioning system air handler is operating.
4. Balanced ventilation – may be a single packaged unit containing supply and exhaust fans that move approximately the same airflow through a heat or energy recovery core, or may use separate fans without heat exchange. In both cases, air supplied from outdoors must be filtered. (See Section 4.4.1.14 for filter requirements.)

##### 4.6.4.1 Exhaust Ventilation

Exhaust ventilation is typically provided using a quiet, continuously operating ceiling-mounted fan or attic-mounted inline fan. Air is drawn from the house or unit and

exhausted to the outdoors. Outdoor air enters the house or unit through infiltration. Many high-quality, quiet fans are available for this purpose. For larger homes, more than one fan may be used. The same fan can be used to meet dwelling unit and local (bathroom or laundry) exhaust ventilation requirements. Inline fans can be used to exhaust air from one or more bathrooms. Remotely located fans (fans mounted outside habitable spaces) are exempt from the sound requirements if there is at least 4 feet of ductwork between the fan and the interior grille.

**Figure 4-28: Exhaust Ventilation Example**

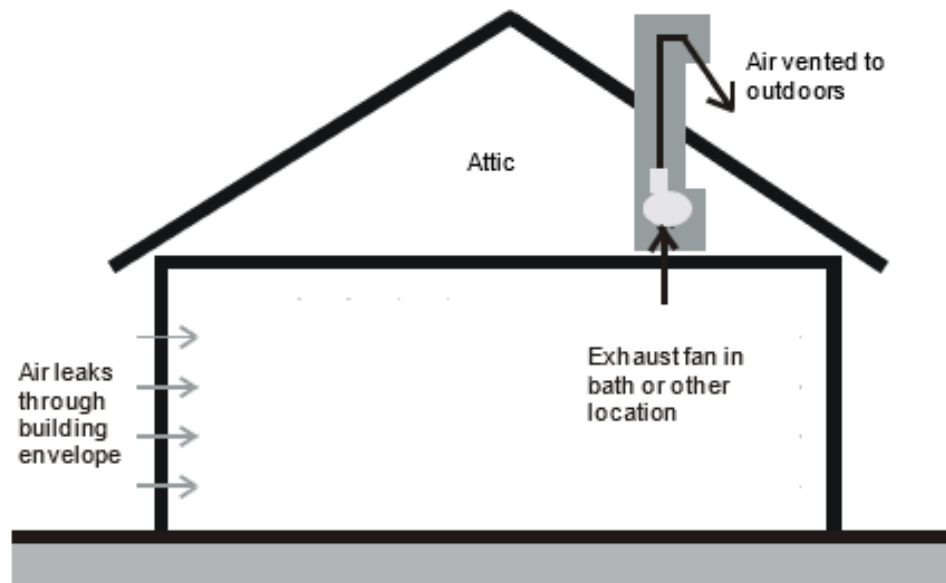

Source: California Energy Commission

#### 4.6.4.2 Supply Ventilation

Supply ventilation systems draw outdoor air into the house using a dedicated supply fan and most likely distribute ventilation air through supply ductwork, although that is not a requirement. Indoor air escapes through leaks in the building envelope (exfiltration), as shown in Figure 4-29. For larger homes, more than one fan may be used. Remotely located fans (fans mounted outside habitable spaces) are exempt from the sound requirements if there is at least 4 feet of ductwork between the fan and the interior grille. Thus, if less than 4 feet of ductwork are used, the supply fan must meet the maximum 1.0 sone rating requirement for dwelling unit ventilation fans.

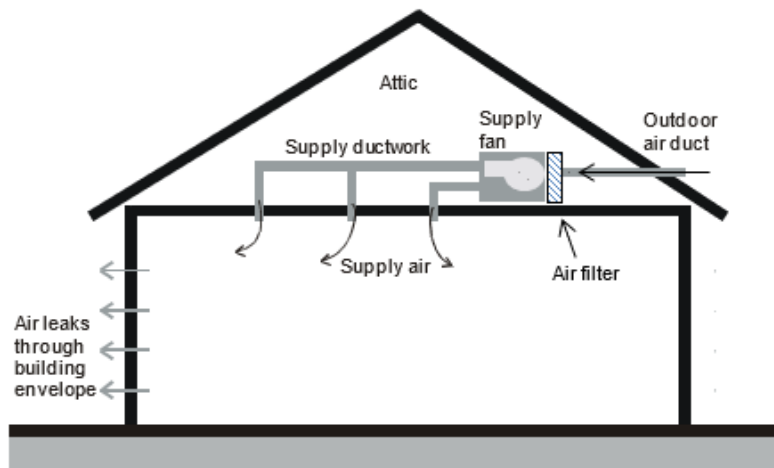
**Figure 4-29: Supply Ventilation Example**

Source: California Energy Commission

Section 150.0(m)12 requires that outside air be filtered using MERV 13 (or greater) air filters. The installed filter must be accessible for routine inspection and replacement. Supply systems may locate the MERV 13 air filter either upstream or downstream of the fan as long as the incoming outdoor air is filtered prior to delivery to the dwelling unit habitable space. Supply fans may be located in attics, dropped ceilings, soffits, or other spaces dedicated for installation of mechanical equipment.

With supply ventilation, the source of outdoor air should be carefully chosen to avoid introducing contaminants such as vehicle exhaust, vents from indoor combustion appliances or local exhaust fans, and smoke from outdoor barbeque areas. To optimize the indoor distribution of filtered outdoor air, the supply airstream can be ducted directly to bedrooms and living areas using an appropriately sized, and sealed ventilation-only supply duct system.

#### 4.6.4.3 Central Fan-Integrated (CFI) Ventilation

A central fan integrated (CFI) ventilation system is a configuration where the ventilation ductwork is connected to the space conditioning duct system, to enable distribution of ventilation air to the dwelling unit when the space conditioning system air handler is operating. This strategy mixes the outdoor air with the large volume of return air from the dwelling unit before being distributed. CFI ventilation systems consume a relatively high amount of energy compared to the other ventilation types because it uses the air handler fan. The Energy Code includes the following requirements specific to CFI ventilation systems:

1. Continuous Operation is Prohibited – The continuous operation of a space conditioning air handler is prohibited in providing whole-dwelling unit ventilation.

2. Outdoor Air Damper(s) – A motorized damper must be installed on any ventilation duct that connects outdoor air to the space conditioning duct system and must prevent airflow into or out of the space conditioning duct system when the damper is in the closed position.
3. Damper Control – The outdoor air damper must be controlled to be in the open position only when outdoor air is required for whole-dwelling unit ventilation and must be in the closed position when outdoor air is not required. The damper must be in the closed position when the air handler is not operating. If the outdoor airflow is fan-powered, then the outdoor air fan must not operate when the outdoor air damper is in the closed position.
4. Variable Ventilation Control – CFI ventilation systems must have controls that track outdoor air ventilation run time, and either open or close the motorized damper depending on whether the required whole-dwelling unit ventilation airflow rate is being met. During periods when space conditioning is not called for by the space conditioning thermostat, the controls must operate the air handler fan and the outdoor air damper(s) when necessary to ensure the required whole-dwelling unit ventilation airflow rate is met. This control strategy must be in accordance with ASHRAE 62.2 section 4.5 which requires controls to operate the fan at least once every three hours, and the average whole-dwelling unit ventilation airflow rate over any 3-hour period must be greater than or equal to the required whole-dwelling unit ventilation airflow rate.

**Figure 4-30: Central Fan-Integrated (CFI) Ventilation Example**

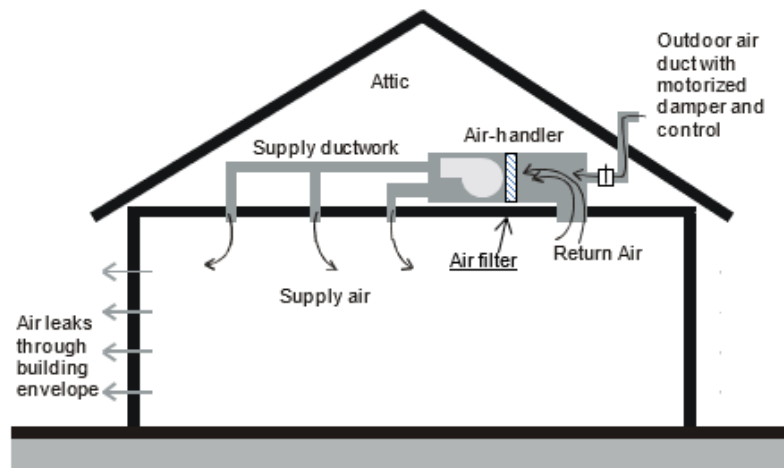

Source: California Energy Commission

Section 150.0(m)12 requires that outside air be filtered using MERV 13 (or greater) rated air filters. Filters must be accessible to simplify replacement. For CFI systems, the filters must be installed upstream of the cooling or heating coil; thus, the filter rack provided at the inlet to the air handler may be used. Otherwise, filters must be provided at the return grill(s) for the central fan, and another filter must be provided

in the outside air ductwork before the point the outside air enters the return plenum of the central fan.

When considering system design and HERS verification compliance for CFI ventilation systems, it is important to distinguish between the central forced-air system fan total airflow and the much smaller outdoor ventilation airflow rate. Both of these airflows must be verified by a HERS Rater. Refer to Figure 4-30 and note that the total airflow through the air handler is the sum of the return airflow and the ventilation airflow. CFI ventilation systems, devices, and controls may be approved for use for compliance with the HERS field verification requirements for whole-dwelling unit mechanical ventilation in accordance with RA3.7.4.2. CFI ventilation systems are considered intermittent mechanical ventilation systems and must be certified to the Energy Commission that the CFI ventilation system will meet the minimum whole-dwelling unit ventilation requirements of Section 150.0(o).

A listing of certified [CFI ventilation systems](#) is posted at the following URL:

[http://www.energy.ca.gov/title24/equipment\\_cert/imv/](http://www.energy.ca.gov/title24/equipment_cert/imv/)

The outside air ducts for CFI ventilation systems are not allowed to be sealed/taped off during duct leakage testing. However, CFI outdoor air ductwork are required to have controlled motorized dampers that open only when outdoor air ventilation is required and close when outdoor air ventilation is not required, may be closed during duct leakage testing. See RA3.1.4.3 for duct leakage verification and diagnostic test protocols.

Because CFI ventilation systems can use a large amount of electricity annually compared to other ventilation system types, the air handlers used in CFI ventilation systems are required to meet the fan watt draw requirements given in Section 150.0(m)13B in all climate zones.

#### 4.6.4.4 **Balanced Ventilation**

Balanced systems use an exhaust fan and a supply fan to move approximately the same volume of air into and out of the dwelling. To be considered a balanced ventilation system, the total supply airflow and the total exhaust airflow must be within 20 percent of each other. For determining compliance, the average of the supply and exhaust airflows is equal to the balanced system airflow rate. (Refer to RA3.7.4.1.2.)

Some balanced systems are small packaged systems that include heat exchangers that temper incoming air with outgoing air, which reduces the thermal effect of ventilation on heating and cooling loads, but the dual fans also increase electrical energy use. They are most practical for use in tightly sealed houses and in multifamily units where exhaust type systems have difficulty drawing adequate outside air due to limited exterior wall area.

Section 150.0(m)12 requires that outside air be filtered using MERV 13 (or greater) air filters. The filters must be accessible to facilitate replacement. An example of a heat recovery ventilator is shown in Figure 4-31.

The outdoor air inlet should be located to avoid areas with contaminants such as smoke produced in barbeque areas and products of combustion emitted from gas appliance vents. Air may not be drawn from attics or crawlspaces.

**Figure 4-31: Balanced Ventilation Example 1 – HRV or ERV**

If supply and exhaust airflows are balanced, the system has no effect on indoor pressure

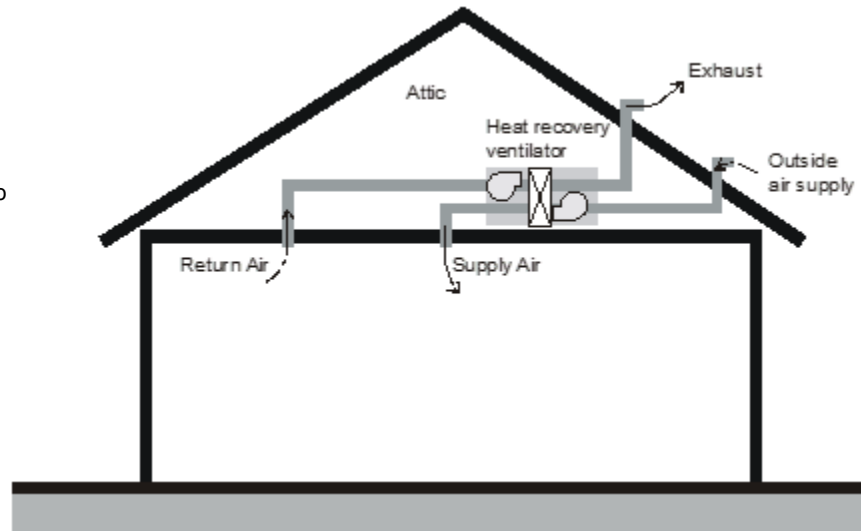

Source: California Energy Commission

Another balanced system configuration uses a stand-alone supply fan coupled with a stand-alone exhaust fan, both wired to a common switch or control to ensure they operate simultaneously. The controls must make it possible to adjust the speed of the fans for balancing the airflows within 20 percent. An example is shown in Figure 4-32.



**Figure 4-32: Balanced Ventilation Example 2 – Separate Supply and Exhaust Fan**

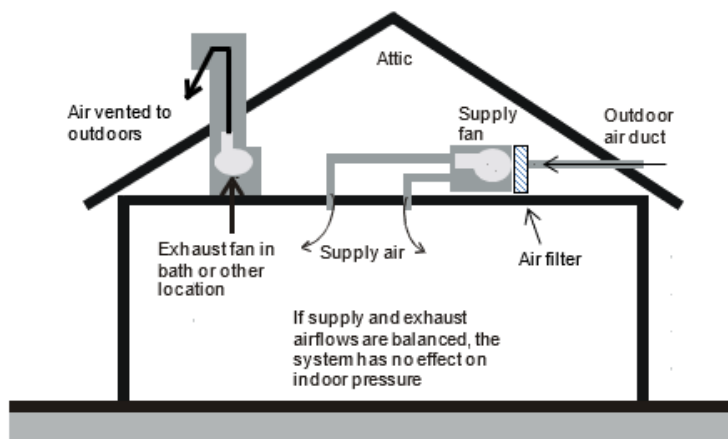

Source: California Energy Commission

Source: California Energy Commission

#### 4.6.5 Whole-Dwelling Unit Ventilation Airflow Measurement

Residential Appendix RA3.7.4 provides direction for field measurement of supply, exhaust, and balanced ventilation system types. These measurement procedures are applicable for ventilation systems that operate at a specific airflow rate or systems that operate intermittently at a fixed speed (averaged over any three-hour period), according to a control with a fixed schedule that is verifiable by a HERS rater on site. (Refer to ASHRAE 62.2 Section 4.5.1 Short Term Average Ventilation.)

Variable or intermittent operation that complies with ASHRAE 62.2 Sections 4.5.2 and 4.5.3 complies with the dwelling unit mechanical ventilation requirements by use of varying ventilation airflow rates based on complicated calculations for relative exposure as specified in ASHRAE 62.2 Normative Appendix C. These calculation procedures provide the basis for "smart" ventilation controls implemented by use of digital controls that rely on the manufacturer's product-specific algorithms or software. Any ventilation system models that use these complex ventilation system controls in a ventilation product designed to be used to comply with Standards Section 150.0(o) must submit an application to the Energy Commission to have the ventilation technology approved. These manufacturers are expected to provide with their applications evidence that the system will perform to provide the required dwelling unit mechanical ventilation. The manufacturers are also expected to provide a method that could be used by a HERS Rater to verify that an installed system is operating as designed.

[Listings of systems approved by the Energy Commission](https://www.energy.ca.gov/rules-and-regulations/building-energy-efficiency/manufacture-certification-building-equipment) are located at the following URL: <https://www.energy.ca.gov/rules-and-regulations/building-energy-efficiency/manufacture-certification-building-equipment>

#### 4.6.6 Dwelling Unit Ventilation Rate

Dwelling unit ventilation systems may operate continuously or intermittently. If fan operation is not continuous, the average ventilation rate over any three-hour period must be greater than or equal to the  $Q_{fan}$  value calculated using equations in this section.

ASHRAE 62.2 allows for scheduled ventilation and real-time control, but these control approaches require “equivalent exposure” calculations using methods in Normative Appendix C, and complex controls would be required to operate the fan.

Equations for calculating  $Q_{fan}$  (the required mechanical ventilation rate) for single-family houses and townhouses are listed below. Single-family detached dwelling units and attached dwelling units not sharing ceilings or floors with other dwelling units, occupiable spaces, public garages, or commercial spaces (e.g. duplexes and townhomes) can take credit for building infiltration using the calculations below.

For ventilation airflow calculations, building infiltration rate ( $Q_{inf}$ ) varies by climate zone (Table 4-14) and building height. Therefore, the value for  $Q_{fan}$  for a single-family dwelling or townhome may also vary based on climate zone and building height.

When the performance compliance approach is used, the compliance software completes all the calculations given in Equations 4-1, 4-2, 4-3, and 4-4, and  $Q_{fan}$  is reported on the CF1R. If the prescriptive compliance approach is used, the Data Registry performs the calculations and the value for  $Q_{fan}$  is recorded on the CF1R.

##### 4.6.6.1 Total Ventilation Rate ( $Q_{tot}$ )

The total ventilation rate is the combined volume of ventilation air provided by infiltration and the mechanical ventilation provided from fans, as follows:

$$Q_{tot} = 0.03A_{floor} + 7.5(N_{br} + 1) \quad \text{Equation 4-1}$$

Where:

$Q_{tot}$  = total required ventilation rate (CFM)

$A_{floor}$  = conditioned floor area (ft<sup>2</sup>)

$N_{br}$  = number of bedrooms (not less than one)

#### 4.6.6.2 Infiltration Rate ( $Q_{inf}$ )

For single-family homes, when determining the required dwelling unit mechanical ventilation airflow rate ( $Q_{fan}$  in Equation 4-4), the calculated value for estimated infiltration rate ( $Q_{inf}$  in Equation 4-2) is deducted from the value of  $Q_{tot}$  (determined by Equation 4-1). The calculated value for estimated infiltration rate depends on the building leakage, building height, and the weather and shielding factor, which varies by climate zone (Table 4-14). A default envelope leakage value of 2 ACH<sub>50</sub> is mandatory for the fan sizing calculations unless a blower door measurement is performed that determines a leakage rate below 2 ACH<sub>50</sub>. Leakage in ACH<sub>50</sub> must be converted to CFM<sub>50</sub> for use in subsequent calculations. Conversion of 2 ACH<sub>50</sub> is shown in Equation 4-2.

$$Q_{50} = V_{du} \times 2 \text{ ACH}_{50} / 60 \quad \text{Equation 4-2}$$

Where:

$Q_{50}$  = leakage rate at 50 Pa, CFM

$V_{du}$  = dwelling unit conditioned volume, ft<sup>3</sup>

$ACH_{50}$  = air changes per hour at 50 Pa (0.2 inch water)

$V_{du}$  can be approximated by multiplying the average ceiling height by the dwelling conditioned floor area. If the field-verified value for ACH<sub>50</sub> is less than 2, then the verified value is used in Equation 4-2 instead of 2.

The effective annual infiltration rate ( $Q_{inf}$ ) is calculated using the weather/shielding factor (*wsf*) for the applicable climate zone and the building height. See Table 4-14 below and Energy Code Table 150.0-D for values for *wsf*.

$$Q_{inf} = 0.052 \times Q_{50} \times wsf \times [H/H_r]^z \quad \text{Equation 4-3}$$

Where:

$Q_{inf}$  = effective annual infiltration rate, CFM

$Q_{50}$  = leakage rate at 50 Pa, CFM

*wsf* = weather and shielding factor from Table 4-13

$H$  = vertical distance between the lowest and highest above-grade points within the pressure boundary

$H_r$  = reference height = 8.2 ft

$z = 0.4$ , for the purpose of calculating  $Q_{inf}$

The number of stories multiplied by the average ceiling height (as entered in compliance software) provides sufficient accuracy for determining  $H$ .

**Table 4-13: Weather and Shielding Factors by Climate Zone**

CZ	WSF	CZ	WSF
1	0.56	9	0.39
2	0.49	10	0.42
3	0.54	11	0.50
4	0.48	12	0.51
5	0.52	13	0.45
6	0.45	14	0.58
7	0.40	15	0.45
8	0.36	16	0.44

Source: Energy Code Table 150.0-D

#### 4.6.6.3 Required Mechanical Ventilation Rate ( $Q_{fan}$ )

The required mechanical ventilation rate,  $Q_{fan}$  is the total outside airflow required to be supplied to (or total indoor air required to be exhausted from) the building by fans. For balanced ventilation system, the average of the supply and exhaust airflows must be greater than or equal to  $Q_{fan}$ .

$Q_{fan}$  is calculated using Equation 4-4 below, which uses the values for  $Q_{tot}$  and  $Q_{inf}$  determined above. Equation 4-4 accounts for reduced exterior wall leakage area in attached units (e.g., townhomes and duplexes). Equation 4-4 also accounts for the differences in ventilation effectiveness of balanced systems compared to exhaust/supply (unbalanced) systems due to varying dwelling infiltration leakage rates. If  $Q_{fan}$  is less than 10 CFM, then no fan is required.

$$Q_{fan} = Q_{tot} - \Phi ( Q_{inf} \times A_{ext} ) \quad \text{Equation 4-4}$$

Where:

$Q_{total}$  = total required ventilation rate (CFM)

$Q_{inf}$  = effective annual average infiltration rate (CFM)

$\Phi$  = 1 for balanced ventilation systems or  $Q_{inf}/Q_{tot}$  for other system types

$A_{ext}$  = 1 for single-family detached homes. For attached dwelling units not sharing ceilings or floors with other dwelling units, occupiable spaces, public garages, or commercial spaces (e.g., duplexes and townhomes),  $A_{ext}$  is the ratio of exterior envelope surface area that is not attached to garages or other dwelling units to total envelope surface area.

**Example 4-11 – Required Ventilation****Question:**

What is the required continuous ventilation rate for a three-bedroom, 1,800 ft<sup>2</sup> 2-story townhouse located in Climate Zone 8 that has 9-foot ceilings, and where 25% of the exterior wall surface area adjoins another unit? Ventilation is provided by a bathroom exhaust fan. No extraordinary measures have been taken to seal the building.

**Answer:**

Equation 4-1 yields a total ventilation rate of 84 CFM

$$Q_{tot} = 0.03A_{floor} + 7.5(N_{br} + 1) = 0.03(1800) + 7.5(3 + 1) = 84 \text{ CFM}$$

The volume is  $1,800 \times 9 = 16,200 \text{ ft}^3$ . Solving for Equation 4-2 results in a leakage rate of 540 CFM

$$Q_{50} = V_{du} \times 2 \text{ ACH}_{50} / 60 = 16,200 \times 2 / 60 = 540 \text{ CFM}$$

Using Equation 4-3:  $Q_{inf} = 0.052 \times Q_{50} \times wsf \times [H/H_r]^2 = 0.052 \times 540 \times 0.36 \times (18/8.2)^{0.4} = 14 \text{ CFM}$

And applying Equation 4-4, the mechanical ventilation system must move 82 CFM.

$$Q_{fan} = Q_{tot} - (Q_{inf}/Q_{tot})(Q_{inf} \times A_{ext}) = 84 - (14/84)(14 \times (1-0.25)) = 82 \text{ CFM}$$

Due to the reduction in infiltration resulting from reduced exterior wall area and to the use of an exhaust fan instead of a balanced system, the effective infiltration credit is only 2 CFM.

**Example 4-12****Question:**

The two-story house I am building in Climate Zone 12 has a floor area of 2,240 ft<sup>2</sup> and four bedrooms. I am using an HRV that delivers 80 CFM of outdoor air and exhausts 90 cfm of indoor air. My calculations come out to 86 CFM. Can I use this system?

**Answer:**

No. For balanced systems, the supply and exhaust airflows can be averaged, and in this case, they average 85 CFM, which is slightly less than the required 86 CFM.

The nominal rating of a fan can be different than what it actually delivers when installed and connected to ductwork, so designers should always include a safety margin when sizing equipment. The length and size of ducting should be used to calculate the pressure drop. This is why dwelling unit ventilation rates must be verified by a HERS Rater.

## Example 4-13

**Question:**

A 2,300 ft<sup>2</sup> house has exhaust fans running continuously in two bathrooms, providing a total exhaust flow rate of 90 CFM, but the requirement is 98 CFM. What are the options for providing the additional 8 CFM?

**Answer:**

Option 1: The required additional CFM could be provided either by increasing the size of either or both exhaust fans such that the combined airflow exceeds 98 CFM.

Option 2: Another solution would be to use a balanced system, which may reduce the airflow requirement to below 90 CFM. Adding another 8 CFM fan is not an acceptable solution.

---

## Example 4-14

**Question:**

A CFI system is connected to the return air plenum of a furnace such that when operating, 10% of the air supplied by the furnace is outdoor air. The CFI control limits furnace fan operation to 30 minutes of every hour. If the house requires 100 CFM of continuous ventilation air, what volume of air must the furnace deliver?

**Answer:**

Since the furnace operates half the time, the volume of outside air delivered when it is operating must be  $2 \times 100 = 200$  CFM. Therefore, the furnace must be able to deliver  $200/0.1 = 2,000$  CFM.

## Example 4-15

**Question:**

Can an exhaust fan be used to supplement ventilation air provided by a CFS system?

**Answer:**

Yes. In the example above, if an exhaust fan is operated continuously to deliver 50 CFM, then the volume of air required of the CFI system is reduced to 100 CFM, or an average of 50 CFM over the hour such that the sum of ventilation air delivered averages 100 CFM. A 1,000 CFM furnace providing 10% outside air could be used in this case. Even though such a combined ventilation system is partially balanced, it would not qualify as a balanced system in the calculation of  $Q_{fan}$ .

## Example 4-16

**Question:**

I want to provide controls that disable the ventilation system so it does not bring in outside air during the hottest two hours of the day, and the calculations show I need 80 CFM continuous. How large must my fan be?

**Answer:**

If the average rate over three hours is 80 CFM and the fan only operates one hour, then it must be capable of delivering  $3 \times 80 = 240$  CFM. ASHRAE 62.2 does not allow averaging ventilation over more than a three-hour period.

---

#### 4.6.6.4 Control and Operation

From ASHRAE 62.2, Section 4.4, Control and Operation. A readily accessible manual ON-OFF control, including but not limited to a fan switch or a dedicated branch-circuit overcurrent device, shall be provided. Controls shall include text or an icon indicating the system's function.

Exception: For multifamily dwelling units, the manual ON-OFF control shall not be required to be readily accessible.

From Energy Code Section 150.0(o)1J: Compliance with ASHRAE 62.2 Section 4.4 (Control and Operation) shall require manual ON-OFF control switches associated with whole-dwelling unit ventilation systems to have a label clearly displaying the following text, or equivalent text: "This switch controls the indoor air quality ventilation for the home. Leave switch in the "on" position at all times unless the outdoor air quality is very poor."

ASHRAE 62.2 requires that the ventilation system have an override control that is accessible to the occupants. The control must be capable of being accessed quickly and easily by the occupants. It can be a labeled wall switch or a circuit breaker located in the electrical panel, or it may be integrated into a labeled wall-mounted control. It cannot be buried in the insulation in the attic or inside the installed ventilation fan cabinet. The occupant must have easy access to modify the fan control settings or turn off the system, if necessary.

Bathroom exhaust fans may serve a dual purpose to provide whole-dwelling unit ventilation when operating at a low constant airflow rate and to provide local demand controlled ventilation by operating at a higher "boost" airflow rate, when needed. For these system types, the continuous whole-dwelling unit airflow operation must have an ON/OFF override, which may be located in the bathroom or in a remote accessible location. The "boost" function is controlled by a separate wall switch located in the bathroom or by a motion sensor or humidistat located in the bathroom.

Time-of-day timers or duty-cycle timers can be used to control intermittent dwelling unit ventilation. Manual crank timers cannot be used since the system must operate

automatically without intervention by the occupant. Some controls “look back” over a set time interval to see if the CFI system air handler has already operated for heating or cooling before it turns on the air handler for ventilation-only operation.

See Section 4.6.4 for additional information about Energy Commission approval of ventilation controls.

---

#### Example 4-17 – Control Options

**Question:**

A bathroom exhaust fan is used to provide dwelling unit ventilation for a house. The fan is designed to be operated by a typical wall switch. Is a label on the wall plate necessary to comply with the requirement that controls be “appropriately labeled”?

**Answer:**

Yes. Since the fan is providing the required dwelling unit ventilation, a label is needed to inform the occupant that this switch controls the indoor air quality ventilation for the home and directs the occupant to leave it on unless the outdoor air quality is very poor. If the exhaust fan were serving only the local exhaust requirement for the bathroom, then a label would not be required.

#### Example 4-18 – Thermostatic Control

**Question:**

Ventilation air is provided whenever the air handler operates via a duct run connecting the return side of the central air handler to the outdoors. The system is estimated to run on calls for heating and cooling about 40 percent of the time, averaged over the year. If it is assumed that the air handler runs only 25 percent of the time, and the airflow is sized accordingly, can the system be allowed to run under thermostatic control?

**Answer:**

No. A system under thermostatic control will go through periods with little or no operation when the outdoor temperature is near the indoor set point, or if the system is in setback mode. An intermittently operating ventilation system must be controlled by a timer that will cycle at least once every three hours to assure that adequate ventilation is provided regardless of outdoor conditions. Alternatively, a more complex control may be used if it complies with the requirements in ASSHRAE 62.2 Appendix C. These systems must be approved by the Energy Commission before being allowed for use for compliance with the required dwelling unit ventilation.



Cycle timer controls are available that keep track of when (and for how long) the system operates to satisfy heating/cooling requirements in the home. These controls turn on the central fan to provide additional ventilation air when heating/cooling operation of the central fan has not already operated for a long enough period to provide the required ventilation. When choosing cycle timer controls for compliance, it is necessary to use models that have been approved by the Energy Commission for use for compliance with dwelling unit mechanical ventilation.

---

#### **4.6.7 Whole-Dwelling Unit Mechanical Ventilation Energy Consumption**

For builders using the performance compliance approach, the energy use of whole-dwelling unit ventilation fans is factored into the compliance of the proposed building. Proposed designs with lower fan efficacy, higher W/CFM, than the standard design will get a compliance penalty and proposed designs with higher fan efficacy will get a compliance credit. Whole-dwelling unit ventilation airflow rate is also a factor in the performance approach. Proposed designs exceeding the standard design ventilation airflow rate, higher CFM than the standard, will see a compliance penalty due to the additional fan energy. In most cases the standard design will match the proposed design ventilation rate and compliance will be neutral for airflow rate. However, the standard design will only match the proposed design airflow rate up to a limit and additional airflow will count against the proposed design energy budget. More information on the standard design ventilation fan efficacy and airflow rate limit can be found in the *Residential ACM Reference Manual*. For balanced heat recovery or energy recovery ventilators (H/ERVs), the HVI rated heat recovery efficiency can help offset higher fan energy use for balanced ventilation systems.

The fan efficacy of the central air handler used for a CFI ventilation system must conform to the same fan watt draw (W/CFM) limit as for cooling systems in all climate zones as verified by a HERS Rater in accordance with the diagnostic test protocols given in RA3.3. The RA3.3 verification of CFI systems determines the W/CFM of the total central system airflow, not the W/CFM of the ventilation airflow.

The Energy Code does not regulate the energy use of ventilation fans installed for other purposes, such as local exhaust.

##### **4.6.7.1 Central Fan-Integrated Ventilation Systems – Watt Draw**

*§150.1(f)10*

CFI system automatic controls must operate the central system air handler fan (generally part of every hour of the year) to draw in and distribute ventilation air throughout the dwelling, even when there is no heating or cooling required. The Energy Code prohibits CFI systems from operating continuously. Because the CFI ventilation control increases the central system air handler fan run time significantly, and because typical central system air handler fan and duct systems require a large

amount of power, a CFI ventilation system can use a large amount of electricity annually.

The fan efficacy of CFI systems must be verified using the same methods as required for furnaces and air handlers. (See RA3.3.) The central system air handler must be operating in ventilation mode with the outdoor air damper open and with ventilation air flowing into the return plenum from outside the building.

Furthermore, the airflow that must be measured is the total airflow through the air handler (system airflow), which is the sum of the return airflow, and the outside air ducted to the return plenum (ventilation airflow). To pass the test, the watt draw must be less than or equal to 0.45 W/CFM for furnaces, and 0.58 W/CFM for air handlers that are not gas furnaces, or 0.62 W/CFM for small duct high velocity systems.

#### 4.6.7.1.1 Other Whole-Dwelling Unit Ventilation Systems – Watt Draw

Using the prescriptive or performance approach, the maximum mandatory fan efficacy for HRV/ERVs is 1.0 W/CFM. This must be HERS verified in accordance with RA3.7.4.4. For balanced systems without heat recovery, exhaust, or supply ventilation fans there are no mandatory or prescriptive fan efficacy requirements.

When using the performance approach, the airflow rate and fan watt draw of the fan must be entered into the compliance software. Values for airflow and fan W/CFM information may be available from the [HVI directory](https://www.hvi.org/proddirectory/CPD_Reports/section_1/index.cfm) at [https://www.hvi.org/proddirectory/CPD\\_Reports/section\\_1/index.cfm](https://www.hvi.org/proddirectory/CPD_Reports/section_1/index.cfm). If HVI does not list fan energy for the installed model, use information from the manufacturer's published documentation. When fan energy is listed as CFM/W instead of W/CFM, it is necessary to invert the value to provide W/CFM as input to the compliance software (for example: 4 CFM/ W = 1/4 W/CFM = 0.25 W/CFM).

Dwelling unit ventilation is not compliance neutral and performance compliance will be affected by the proposed design W/CFM, ventilation airflow rate, and heat recovery if present. Installation of designs exceeding the standard design W/CFM or ventilation rate will get a compliance penalty. More information on the standard design ventilation fan W/CFM and airflow rate can be found in the *Residential ACM Reference Manual*.

If an H/ERV is specified, the heat recovery efficiency of the proposed system must be entered into the compliance software so that the heat recovery effect can be accounted for in the compliance simulation. Many factors affect the benefit of heat recovery on ventilation, like climate zone and building design, but in general heat recovery will increase building compliance.

### 4.6.8 Local Mechanical Exhaust

Local exhaust (sometimes called *spot ventilation*) has long been required for bathrooms and kitchens to remove moisture and odors at the source. Building codes have required an operable window or an exhaust fan in bathrooms for many years and have generally required kitchen exhaust either directly through a fan or indirectly through a recirculating range hood and an operable window. The Energy Code recognizes the limitations of these indirect methods of reducing moisture and odors and requires that these spaces be mechanically exhausted directly to outdoors, even if windows are present. Moisture condensation on indoor surfaces is a leading cause of mold and mildew in buildings. The occurrence of asthma is also associated with high interior relative humidity. Therefore, it is important to exhaust the excess moisture from bathing and cooking directly at the source.

The Energy Code requires that each kitchen and bathroom have a local mechanical exhaust system. Generally, this will be a dedicated exhaust fan in each room that requires local exhaust, although ventilation systems that exhaust air from multiple rooms using a duct system connected to a single exhaust fan are allowed as long as the minimum local exhaust requirement is met in all rooms served by the system.

The Energy Code follows the ASHRAE 62.2 definitions for kitchens and bathrooms for these ventilation requirements. Kitchens are any rooms containing cooking appliances, and bathrooms are any rooms containing a bathtub, shower, spa, or other similar source of moisture. A room containing only a toilet is not required to have an exhaust fan; ASHRAE 62.2 assumes there is an adjacent bathroom with local exhaust.

Non-enclosed kitchens are required to have demand-controlled local exhaust (as described in Section 4.6.7.1). Enclosed kitchens and bathrooms can have either demand-controlled local exhaust or continuous local exhaust (as described in Section 4.6.7.2). Local exhaust systems must be rated for airflow in accordance with ASHRAE 62.2 section 7.1.

Building codes may require that fans used for kitchen range hood exhaust ventilation be safety-rated by UL or some other testing agency for the particular location and/or application. Typically, these requirements address fire safety issues of fans placed within an area defined by a set of lines at 45° outward and upward from the cooktop. Few bathroom exhaust fans will have this rating, so they cannot be used in these locations.

**Example 4-19 – Local Exhaust Required for Toilet****Question:**

I am building a house with 2½ baths. The half-bath consists of a room with a toilet and sink. Is local exhaust required for the half bath?

**Answer:**

No. Local exhaust is required only for bathrooms, which are defined in the Energy Code as rooms with a bathtub, shower, spa or some other similar source of moisture. This does not include a simple sink for occasional hand washing.

**Example 4-20****Question:**

The master bath suite in a house has a bathroom with a shower, spa, and sinks. The toilet is in a separate, adjacent room with a full door. Where do I need to install local exhaust fans?

**Answer:**

The standards require local exhaust only in the bathroom, not the separate toilet room.

---

**4.6.8.1 Demand-Controlled (Intermittent) Local Exhaust**

The Energy Code requires that local exhaust fans be designed to be operated by the occupant. This usually means that a wall switch or some other control is accessible and obvious. There is no requirement to specify where the control or switch needs to be located, but bathroom exhaust fan controls are generally located next to the light switch, and kitchen exhaust fan controls are generally integrated into the range hood or mounted on the wall or counter adjacent to the range hood.

Bathrooms can use a variety of exhaust strategies. They can use ceiling-mounted exhaust fans or may use a remotely mounted fan ducted to two or more exhaust grilles. Demand-controlled local exhaust can be integrated with the dwelling unit ventilation system to provide both functions. Kitchens can have range hood exhaust fans, down-draft exhausts, ceiling- or wall-mounted exhaust fans, or pickups for remote-mounted inline exhaust fans. Generally, HRV/ERV manufacturers do not allow exhaust ducting from the kitchen because of the heat, moisture, grease, and particulates that should not enter the heat exchange core. Building codes require kitchen exhaust fans to be connected to metal ductwork for fire safety.

**Example 4-21 – Ducting Kitchen Exhaust to the Outdoors****Question:**

How do I know what kind of duct I need to use? I've been using recirculating hoods my entire career, now I need to vent to the outdoors. How do I do it?

**Answer:**

A kitchen range hood or downdraft duct is generally a smooth metal duct that is sized to match the outlet of the ventilation device. It is often a six-inch or seven-inch-round duct, or the range hood may have a rectangular discharge. If it is rectangular, the fan will typically have a rectangular-to-round adapter included. Always use a terminal device on the roof or wall that is sized to be at least as large as the duct. Try to minimize the number of elbows used.

**Example 4-22****Question:**

How do I know what the requirements are in my area?

**Answer:**

Ask your code enforcement agency for that information. Some enforcement agencies will accept metal flex; some will not.

---

**A. Control and Operation for Intermittent Local Exhaust**

The choice of control is left to the designer. It can be a manual switch or automatic control like an occupancy sensor. Some exhaust fans have multiple speeds, and some fan controls have a delay-off function that operates the exhaust fan for a set time after the occupant leaves the bathroom. New control strategies continue to come to the market. The only requirement is that there is a control. Title 24, Part 11 may specify additional requirements for the control and operation of intermittent local exhaust.

**B. Ventilation Rate for Demand-Controlled Local Exhaust**

Cooking is a regularly occurring activity inside a home that causes indoor pollution. The most effective method in removing pollutants generated from cooking is to use a vented kitchen range hood, which removes pollutants above the cooking surface before they mix with the air in the rest of the home. The 2022 Energy Code incorporates a new metric for local exhaust called capture efficiency. Capture efficiency is defined as the fraction of emitted tracer gas that is directly exhausted by a range hood.

To adequately capture the moisture, particulates, and other products of cooking and/or combustion in kitchens, the Energy Code requires minimum ventilation rates or capture efficiencies in Table 4-15 and Table 4-16. Only in kitchens that are

enclosed, the exhaust requirement can also be met with either a ceiling or wall-mounted exhaust fan or with a ducted fan or ducted ventilation system that can provide at least five air changes of the kitchen volume per hour. Recirculating range hoods that do not exhaust pollutants to the outside cannot be used to meet the requirements of ASHRAE Standard 62.2.

**Table 4-15: Demand-Controlled Local Ventilation Exhaust Airflow Rates (from Table 150.0-E)**

<b>Application</b>	<b>Airflow</b>
Enclosed Kitchen	<ul style="list-style-type: none"> <li>• Vented range hood (including appliance-range hood combinations): capture efficiency or airflow rate specified in Table 4-14.</li> <li>• Other kitchen exhaust fans, including downdraft: 300 CFM (150 L/s) or a capacity of 5 ACH</li> </ul>
Non-Enclosed Kitchen	<ul style="list-style-type: none"> <li>• Vented range hood (including appliance-range hood combinations): capture efficiency or airflow rate specified in Table 4-14.</li> <li>• Other kitchen exhaust fans, including downdraft: 300 CFM (150 L/s)</li> </ul>
Bathroom	<ul style="list-style-type: none"> <li>• 50 CFM (25 L/s)</li> </ul>

**Table 4-14: Kitchen Range Hood Airflow Rates and Capture Efficiency Ratings (from Table 150.0G)**

<b>Dwelling Unit Floor Area (ft<sup>2</sup>)</b>	<b>Hood Over Electric Range</b>	<b>Hood Over Gas Range</b>
>1500	50% CE or 110 cfm	70% CE or 180 cfm
>1000 - 1500	50% CE or 110 cfm	80% CE or 250 cfm
750 - 1000	55% CE or 130 cfm	85% CE or 280 cfm

<750	65% CE or 160 cfm	85% CE or 280 cfm
------	----------------------	-------------------

The Energy Code requires verification that range hoods are HVI or AHAM-certified to provide at least one speed setting at which they can deliver at least 100 CFM at a noise level of 3 sones or less. Verification must be in accordance with the procedures in RA3.7.4.3. Range hoods that have a minimum airflow setting exceeding 400 CFM are exempt from the noise requirement.

Ratings for Local Exhaust Fans are listed at the following web pages:

- [Home Ventilating Institute \(HVI\)](https://www.hvi.org/proddirectory/CPD_Reports/section_1/index.cfm) at [https://www.hvi.org/proddirectory/CPD\\_Reports/section\\_1/index.cfm](https://www.hvi.org/proddirectory/CPD_Reports/section_1/index.cfm)
- [Association of Home Appliance Manufacturers \(AHAM\)](https://www.aham.org/AHAM/What_We_Do/Kitchen_Range_Hood_Certification) at [https://www.aham.org/AHAM/What\\_We\\_Do/Kitchen\\_Range\\_Hood\\_Certification](https://www.aham.org/AHAM/What_We_Do/Kitchen_Range_Hood_Certification)

ASHRAE Standard 62.2 limits exhaust airflow when atmospherically vented combustion appliances are located inside the pressure boundary. This is particularly important to observe when large range hoods are installed. Refer to Section 4.6.9.4 below for more information.

---

Example 4-23 – Ceiling or Wall Exhaust vs Demand-Controlled Range Hood in an Enclosed Kitchen

**Question:**

I am building a house with an enclosed kitchen that is 12 ft. x 14 ft. with a 10 ft. ceiling. What size ceiling exhaust fan or range hood fan is required?

**Answer:**

If a range hood exhaust is not used, either 300 CFM or 5 ACH minimum airflow is required. The kitchen volume is 12 ft. x 14 ft. x 10 ft. = 1,680 ft<sup>3</sup>. Five air changes are a flow rate of 1,680 ft<sup>3</sup> x 5/ hr. ÷ 60 min/hr = 140 CFM. So, this kitchen must have a ceiling or wall exhaust fan of 140 CFM. Otherwise, a vented range hood fan that provides at least 100 CFM is required.

---

#### 4.6.8.2 Continuous Local Exhaust

The Energy Code allows the designer to install a local exhaust system that operates without occupant intervention continuously and automatically during all occupiable hours. Continuous local exhaust is generally specified when the local exhaust ventilation system is combined with a continuous dwelling unit ventilation system. For example, if the dwelling unit ventilation is provided by a continuously operating exhaust fan located in the bathroom, this fan may also satisfy the local exhaust requirement for that bathroom, provided the fan provides airflow greater than or

equal to the minimum continuous local ventilation airflow rate. Continuous local exhaust may also be part of a pickup, or an interior grille, for a remote fan or HRV/ERV system.

Continuously operating bathroom exhaust fans must operate at a minimum of 20 CFM. Continuously operating kitchen exhaust fans are permitted only for enclosed kitchens.

**Table 4-17: Continuous Local Ventilation Exhaust Airflow Rates (from Table 150.0-F)**

Application	Airflow
Enclosed Kitchen	5 ACH, based on kitchen volume
Bathroom	20 CFM (10 L/s)

Example 4-24 – Continuous Kitchen Exhaust

**Question:**

A new house has an open-design, 12 ft. x18 ft. ranch kitchen with 12 ft. cathedral ceilings. What airflow rate will be required for a continuous exhaust fan?

**Answer:**

A continuous exhaust fan cannot be used in non-enclosed kitchens. A vented range hood must be provided.

**4.6.9 Other Requirements (Section 6 of ASHRAE 62.2)**

**4.6.9.1 Adjacent Spaces and Transfer Air**

From ASHRAE 62.2,

6.1 Adjacent Spaces and Transfer Air. Measures shall be taken to minimize air movement across envelope components to dwelling units from adjacent spaces such as garages, unconditioned crawlspaces, unconditioned attics, and other dwelling units. Pressure boundary wall, ceiling, and floor penetrations shall be sealed, as shall any vertical chases adjacent to dwelling units. Doors between dwelling units and common hallways shall be gasketed or made substantially airtight.

Supply and balanced ventilation systems shall be designed and constructed



to provide ventilation air directly from the outdoors.

ASHRAE Standard 62.2 requires that the air used for ventilation come from outdoors. Air may not be drawn in as transfer air from other spaces that are outside the occupiable space of the dwelling unit, or from between dwelling units and corridors. This is to prevent airborne pollutants originating in those other spaces from contaminating the dwelling unit. For example, drawing ventilation air from the garage could introduce VOCs or pesticides into the indoor air. Drawing ventilation air from an unconditioned crawlspace could cause elevated allergen concentrations in the dwelling such as mold spores, insects, or rodent allergens. Likewise, drawing air from an adjacent dwelling could introduce unwanted contaminants such as cooking odors or cigarette smoke.

In addition to designing the ventilation system to introduce outdoor air, ASHRAE 62.2 also requires that measures be taken to prevent air movement between adjacent spaces, such as attics, garages, crawlspaces, and utility chases. This includes thorough air sealing of envelope components, pressure management and use of airtight recessed ceiling light fixtures. The measures must apply to adjacent units above and below, as well as side by side.

Air sealing must include pathways in vertical components such as demising walls and walls common to the unit and an attached garage, and in horizontal components such as floors and ceilings. Pipe and electrical penetrations are examples of leakage areas that require sealing.

#### 4.6.9.2 Instructions and Labeling

From ASHRAE 62.2, Section 6.2, Instructions and Labeling.

Information on the ventilation design and/or ventilation systems installed, instructions on their proper operation to meet the requirements of this standard, and instructions detailing any required maintenance (similar to that provided for HVAC systems) shall be provided to the owner and the occupant of the dwelling unit. Controls shall be labeled as to their function (unless that function is obvious, such as toilet exhaust fan switches).

From Energy Code Section 150.0(o)1J:

Compliance with ASHRAE 62.2 Section 4.4 (Control and Operation) shall require manual ON-OFF control switches associated with whole-dwelling unit ventilation systems to have a label clearly displaying the following text, or equivalent text: "This switch controls the indoor air quality ventilation for the home. Leave switch in the "on" position at all times *unless the outdoor air quality is very poor.*

Field studies have shown that switches for exhaust fans do not have the required labels, and that many homeowners do not understand the importance of continuous

operation of the ventilation fans for maintaining indoor air quality. Standards Section 10-103(b)4 require the builder to leave in the building, for the building owner at occupancy, a description of the quantities of outdoor air that the ventilation system(s) are designed to provide to the conditioned space of the building and instructions for proper operation and maintenance of the ventilation system.

Because the concept of a designed dwelling unit ventilation system may be new to many occupants, the standards section requires that ventilation system controls be labeled as to function. One acceptable option is to affix a label to the electrical panel that provides some basic system operation information.

#### 4.6.9.3 Clothes Dryers

From ASHRAE 62.2, Section 6.3, Clothes Dryers.

Clothes dryers shall be exhausted directly to the outdoors. Exception:  
Condensing dryers plumbed to a drain.

All laundry rooms must be built with a duct to the outdoors, designed to be connected to the dryer. Devices that allow the exhaust air to be diverted into the indoor space to provide extra heating are not permitted. This requirement is consistent with existing clothes dryer installation and design standards.

---

#### Example 4-25 – Clothes Dryer Exhaust Diverter

##### **Question:**

I am building a home that has been purchased prior to completion. The buyer has asked for an exhaust air diverter to be installed in the dryer exhaust duct. He says that it is wasteful of heating energy to exhaust the warm humid air to the outdoors during the winter when the furnace and humidifier are working. He says that the screen on the diverter will prevent excess dust being released into the space. Can I install the device for him?

##### **Answer:**

No. The feature will not comply with the Energy Code. The device is specifically prohibited. Significant amounts of dust are released from such devices, and the moisture in the dryer exhaust can lead to humidity problems, particularly in warmer climates.

---

#### 4.6.9.4 Combustion and Solid-Fuel Burning Appliances

From ASHRAE 62.2, Section 6.4, Combustion and Solid-Fuel Burning Appliances

6.4.1 Combustion and solid-fuel burning appliances must be provided with adequate combustion and ventilation air and installed in accordance with manufacturers' installation instructions, NFPA 31, NFPA 54/ANSI Z223.1, NFPA 211, or other equivalent code acceptable to the building official.

6.4.2 Where atmospherically vented combustion appliances or solid-fuel burning appliances are located inside the pressure boundary, the total net exhaust flow of the two largest exhaust fans (not including a summer cooling fan intended to be operated only when windows or other air inlets are open) shall not exceed 15 CFM per 100 ft<sup>2</sup> (75 L/s per 100 m<sup>2</sup>) of occupiable space when in operation at full capacity. If the designed total net flow exceeds this limit, the net exhaust flow must be reduced by reducing the exhaust flow or providing compensating outdoor air. Gravity or barometric dampers in nonpowered exhaust makeup air systems shall not be used to provide compensating outdoor air. Atmospherically vented combustion appliances do not include direct-vent appliances. Combustion appliances that pass safety testing performed according to ANSI/BPI-1200, shall be deemed as complying with Section 6.4.2.

ASHRAE Standard 62.2 requires that the vent system for combustion appliances be properly installed, as specified by the instructions from the appliance manufacturer and by the California Building Code. Compliance with venting requirements involves determining the type and size of duct material to be used, and routing requirements for the exhaust ducting system.

ASHRAE Standard 62.2 includes a provision intended to prevent back drafting, where one or more exhaust fans are installed in a home with atmospherically vented or solid fuel combustion appliances. If the two largest exhaust fans have a combined capacity that exceeds 15 CFM/100 ft<sup>2</sup> of floor area, then makeup air must be provided. This provision applies only when the atmospherically vented appliance is inside the pressure boundary and the house does not include a summer cooling fan that is designed to be operated only when windows are open. Direct-vent appliances are not considered “atmospherically vented.”

The two largest exhaust fans are normally the kitchen range hood and the clothes dryer (if located inside the dwelling unit pressure boundary). Large-range hoods, particularly downdraft range hoods, can have capacities of 1,000 CFM or more.

Issues relating to this can be solved in several ways. First, all atmospherically vented combustion appliances can be located outside the pressure boundary of the house (to the garage or outdoor utility closet). Second, the flow rate of one or more of the fans can be reduced so the combined exhaust flow is less than 15 CFM/100 ft<sup>2</sup> floor area. Finally, outdoor makeup air can be mechanically provided to reduce the net exhaust rate.

In addition to meeting ASHRAE 62.2, Section 6.4, all dwelling units must also conform to the applicable requirements specified in the California Mechanical Code Chapter 7 for combustion air.

**Example 4-26 – Large Exhaust Fan****Question:**

I am building a 3,600 ft<sup>2</sup> custom home that has four bedrooms. The kitchen will have a high-end range hood that has three speeds, nominally 1,000 CFM, 1,400 CFM and 1,600 CFM. The house will include an atmospherically vented gas water heater located in the basement. If I am using a central exhaust fan for the dwelling unit ventilation of 75 CFM, and there is a clothes dryer installed, how much compensating outdoor airflow (makeup air) is needed?

**Answer:**

You must use the high-speed value for the range hood of 1,600 CFM. The clothes dryer flow is assumed to be 150 CFM for sizing purposes. These two flows are added together for a total exhaust capacity of 1,750 CFM. Since the whole-dwelling unit ventilation fan is not one of the two largest exhaust fans, it does not figure into the makeup air calculation. Using the equation above, at least 1,750 CFM – (15 CFM x 3,600 ft<sup>2</sup> / 100 ft<sup>2</sup>) = 1,210 CFM of makeup outside airflow must be provided

---

**Example 4-27****Question:**

The same custom house will have the water heater located in the garage instead of the basement. Does that change anything?

**Answer:**

Garages (and attics) are normally located outside the pressure boundary, so makeup air is not required. If the garage is inside the pressure boundary of the living space, makeup air is required.

**Example 4-28****Question:**

For this house, I need to keep the natural gas water heater in the basement. What are my options that would avoid the requirement to provide makeup air?

**Answer:**

There are several things you could do. First, you could use a direct vent water heater that would also provide higher fuel efficiency. You could use a lower capacity range hood, one that is less than 390 CFM (15 CFM x 3,600 ft<sup>2</sup> / 100 ft<sup>2</sup> – 150 CFM). Use of continuous supply-only dwelling unit ventilation would allow the hood capacity to increase to 465 CFM (15 CFM x 3,600 ft<sup>2</sup> / 100 ft<sup>2</sup> – 150 CFM + 75 CFM). There are also commercial range hoods available that are designed to provide makeup air.

---

#### 4.6.9.5 Garages

From ASHRAE 62.2, Section 6.5.1, Garages.

When an occupiable space adjoins a garage, the design must prevent migration of contaminants to the adjoining occupiable space. Air seal the walls, ceilings, and floors that separate garages from occupiable space. To be considered air-sealed, all joints, seams, penetrations, openings between door assemblies and their respective jambs and framing, and other sources of air leakage through wall and ceiling assemblies separating the garage from the residence and its attic area shall be caulked, gasketed, weather stripped, wrapped, or otherwise sealed to limit air movement. Doors between garages and occupiable spaces shall be gasketed or made substantially airtight with weather stripping.

Garages often contain numerous sources of air contaminants, including, vehicle exhaust, gasoline fumes, pesticides, paints and solvents. When a garage is attached to the house, these contaminants be prevented from entering the living space. Walls between the home and garage (or garage ceiling in designs with living space above garages) shall be designed and constructed to prevent air flow through the wall or ceiling. Common doors and any air handlers or ducts located in the garage shall also be sealed, weather-stripped, or gasketed.

Energy Code Section 150.0(o) specifies that compliance with ASHRAE 62.2 Section 6.5.2 (Space Conditioning System Ducts) shall not be required. However, applicable duct leakage verification requirements are given in Energy Code Sections 150.0(m)11 for newly constructed buildings, and 150.2(b)1D for alterations to systems in existing buildings. All ducted space conditioning systems in newly constructed buildings are required to pass HERS verification that the duct system leaks less than or equal to 5 percent of the system airflow rate. This requirement also applies to portions of the system that may be in a garage space.

For alterations to space conditioning systems in existing buildings that have all or portions of the forced air ducts, plenums or air-handling units in the garage, Section 150.2(b)1D specifies two compliance approaches:

1. The measured system duct leakage shall be less than or equal to 6 percent of system air handler airflow as determined using the procedures in RA3.1.4.3.1.
2. All accessible leaks located in the garage space shall be sealed and verified through a visual inspection and a smoke test by a certified HERS Rater using the methods specified in RA3.1.4.3.5.

For additions and alterations to existing buildings, any length of new or altered duct located in the garage or any new or altered air-handling unit located in the garage triggers these duct leakage testing requirements.

**Example 4-29 – Garages****Question:**

In a newly constructed building, the building designer located the air handler in the garage. The main return trunk from the dwelling is connected to the air handler. Is this acceptable?

**Answer:**

Yes. The duct system must be leak-tested and verified to leak no more than 5 percent of air handler airflow.

**Example 4-30****Question:**

For an alteration to an existing building, the air handler is located in the dwelling unit, and a portion of the return duct is run through the garage to a bedroom above the garage. The return duct has 4 feet of length located in the garage, and this 4-foot section is being replaced. How do I test that length of the duct for leakage?

**Answer:**

First, test the leakage for the entire duct system to determine whether the total system duct leakage is no greater than 6 percent of the total fan flow. If the system does not meet the 6 percent target for compliance, then use the visual inspection and smoke test specified in RA3.1.4.3.5 and seal all accessible leaks in the 4-foot section of duct that is in the garage space.

---

#### 4.6.9.6 Ventilation Opening Area

From ASHRAE 62.2, Section 6.6 Ventilation Opening Area

Spaces shall have ventilation openings as listed in the following subsections. Such openings shall meet the requirements of Section 6.8.

Exception: Attached dwelling units and spaces that meet the local ventilation requirements set for bathrooms in Section 5.

6.6.1 Habitable Spaces. Each habitable space shall be provided with ventilation openings with an openable area not less than 4% of the floor area or less than 5 ft<sup>2</sup> (0.5 m<sup>2</sup>).

6.6.2 Toilets and Utility Rooms. Toilets and utility rooms shall be provided with ventilation openings with an openable area not less than 4% of the room floor area or less than 1.5 ft<sup>2</sup> (0.15 m<sup>2</sup>).

Exceptions:

1. Utility rooms with a dryer exhaust duct.
2. Toilet compartments in bathrooms.

The dwelling unit mechanical ventilation rate is intended to provide adequate ventilation to typical new homes under normal circumstances. On occasion, however, houses experience unusual circumstances where high levels of contaminants are released into the space. When this occurs, a means of providing the significantly higher levels of ventilation required to remove the contaminants is needed. Operable windows are the most likely means of providing the additional ventilation.

This section of ASHRAE Standard 62.2 requires ventilation openings in habitable spaces, toilets, and utility rooms. Ventilation openings usually mean operable windows, although a dedicated nonwindow opening for ventilation is acceptable. Spaces that meet the local exhaust requirements are exempted from this requirement.

#### 4.6.9.7 Habitable Spaces

Habitable spaces are required to have ventilation openings with an openable area equal to at least 4 percent of conditioned space floor area, but not less than 5 ft<sup>2</sup>. Dining rooms, living rooms, family rooms, bedrooms, and kitchens are considered habitable space. Closets, crawl spaces, garages, and utility rooms are generally not. If the clothes washer and dryer are located in an open basement that is also the family room, it would be considered habitable space.

The openings do not have to be windows. They can also be operable, insulated, weather-stripped panels.

Ventilation openings, which include operable windows, skylights, through-the-wall vents, window vents, or similar devices, shall be readily accessible to the occupant. This means that the occupant must be able to operate the opening without having to climb on anything. An operable skylight must have some means of being operated while standing on the floor: a push rod, a long crank handle, or an electric motor.

If a ventilation opening is covered with louvers or otherwise obstructed, the openable area is the unobstructed free area through the opening.

---

#### Example 4-31 – Ventilation Openings

##### **Question:**

I am building a house with a 14 ft. by 12 ft. bedroom. What size window do I need to install?

##### **Answer:**

It depends on the type of window. The standard requires that the openable area of the window, not the window unit, be 4 percent of the floor area, or  $14 \text{ ft} \times 12 \text{ ft} \times 0.04 = 6.7 \text{ ft}^2$ . The fully opened area of the window or windows must be greater than  $6.7 \text{ ft}^2$ . The requirement for this example can be met using two double-hung windows, each with a fully opened area of  $3.35 \text{ ft}^2$ . Any combination of windows whose opened areas add up to at least  $6.7 \text{ ft}^2$  will meet the requirement.

---

#### 4.6.9.8 Minimum Filtration

Compliance with ASHRAE 62.2 Sections 6.7 (Minimum Filtration) and 6.7.1 (Filter Pressure Drop) are not required (Energy Code Section 150.0(o)1D). However, air filtration for mechanical systems must conform to the specifications in Energy Code Section 150.0(m)12. Information on air filtration requirements is given in Section 4.4.1.14 of this chapter.

#### 4.6.9.9 Air Inlets

From ASHRAE 62.2, Section 6.8, Air Inlets.

Air inlets that are part of the ventilation design shall be located a minimum of 10 ft (3 m) from known sources of contamination such as a stack, vent, exhaust hood, or vehicle exhaust. The intake shall be placed so that entering air is not obstructed by snow, plantings, or other material. Forced air inlets shall be provided with rodent/insect screens (mesh not larger than 1/2 in. [13 mm]).

Exceptions:

1. Ventilation openings in the wall may be as close as a stretched-string distance of 3 ft (1 m) from sources of contamination exiting through the



roof or dryer exhausts.

2. No minimum separation distance shall be required between windows and local exhaust outlets in kitchens and bathrooms.

3. Vent terminations covered by and meeting the requirements of the National Fuel Gas Code (NFPA 54/ANSI Z223.1)7 or equivalent.

4. Where a combined exhaust/intake termination is used to separate intake air from exhaust air originating in a living space other than kitchens, no minimum separation distance between these two openings is required. For these combined terminations, the exhaust air concentration within the intake airflow shall not exceed 10%, as established by the manufacturer.

#### 6.8.1 Ventilation Openings.

Operable windows, skylights, through-the-wall inlets, window air inlets, or similar devices shall be readily accessible to occupants. Where openings are covered with louvers or otherwise obstructed, openable area shall be based on the free, unobstructed area through the opening.

When the ventilation system is designed with outdoor air inlets, the inlets must be located away from locations that can be expected to be sources of contamination. The minimum separation is 10 ft. Inlets include not only inlets to ducts, but windows that are needed to achieve the minimal opening area.

For residential buildings, typical sources of outdoor air contaminants include:

1. Vents from combustion appliances
2. Fireplace chimneys.
3. Exhaust fan outlets.
4. Barbeque grills.
5. Driveways or any location where vehicles may be idling.
6. Any other locations where outdoor air contaminants are generated.

The Energy Code also requires that air intakes be placed so that they will not become obstructed by snow, plants, or other material. Forced air inlets must also be equipped with insect/rodent screens with mesh is no larger than 1/2 inch.

#### **4.6.10 Air-Moving Equipment (Section 7 of ASHRAE 62.2)**

From ASHRAE 62.2, Section 7.1, Selection and Installation.

Ventilation devices and equipment serving individual dwelling units shall be tested in accordance with ANSI/ASHRAE Standard 51/AMCA 210 and ANSI/AMCA Standard 300 and rated in accordance with the airflow and

sound rating procedures of the Home Ventilating Institute (HVI 915, 916, 920). Installations of systems or equipment shall be carried out in accordance with manufacturers' design requirements and installation instructions.

Ventilation systems used to meet whole-dwelling unit or local exhaust ventilation requirements shall be rated to deliver the required airflow and have sound ratings that meet the requirements of this section.

#### 4.6.10.1 Selection and Installation

ASHRAE Standard 62.2 requires that equipment used to comply with the standard be selected based on tested and certified ratings for airflow and sound. Fan selections must meet the requirements of the standard. The HVI or AHAM certified product directories lists equipment that has been tested for performance and sound at available settings and configurations.

In addition, the Energy Code requires that fans be installed in accordance with the manufacturer's instructions. Adherence to the installation instructions and other literature shipped with the fan will ensure the installation complies with the ratings.

#### 4.6.10.2 Sound Ratings for Fans

From ASHRAE 62.2, Section 7.2, Sound Ratings for Fans.

Ventilation fans shall be rated for sound at no less than the minimum airflow rate required by this standard as noted below. These sound ratings shall be at a minimum of 0.1 in. w.c. (25 Pa) static pressure in accordance with the HVI procedures referenced in Section 7.1.

Exception: HVAC air handlers and remote mounted fans need not meet sound requirements. To be considered for this exception, a remote mounted fan must be mounted outside the habitable spaces, bathrooms, toilets, and hallways, and there must be at least 4 ft (1 m) of ductwork between the fan and the intake grille.

7.2.1 Dwelling-Unit Ventilation or Continuous Local Exhaust Fans. These fans shall be rated for sound at a maximum of 1.0 sone.

7.2.2 Demand-Controlled Local Exhaust Fans. Bathroom exhaust fans used to comply with Section 5.2 shall be rated for sound at a maximum of 3 sones. Kitchen exhaust fans used to comply with Section 5.2 shall be rated for sound at a maximum of 3 sones at one or more airflow settings greater

than or equal to 100 CFM (47 L/s).

Exception: Fans with a minimum airflow setting exceeding 400 CFM (189 L/s) need not comply.

Energy Code Section 150.0(o)1G requires kitchen range hoods to be rated for sound in accordance with Section 7.2 of ASHRAE 62.2 and provides an exception to allow kitchen range hoods to be rated for sound at a static pressure determined at working speed as specified in HVI 916 Section 7.2. The static pressure at working speed may be lower than 0.1 inch w.c.

One common reason ventilation equipment may not be operated by occupants, particularly local exhaust fans, is the noise the fans may create. To address this, ASHRAE Standard 62.2 requires that certain fans be rated for sound and that installed fans shall have ratings below specified limits. The sound rating must be done at an airflow that is no less than the airflow that the fan must provide to meet the ventilation airflow requirement.

Because of the variables in length and type of duct and grille, there is no standard test method for rating the sound of ventilation fans that are not mounted in the ceiling or wall surface. Consequently, air handlers, HRV/ERVs, inline fans, and remote fans are exempted from the sound rating requirements that apply to surface-mounted fans. However, to reduce the noise conducted from the fan to the grille, the Energy Codes requires at least 4 feet of ductwork between the fan and surface grille. Especially if hard metal duct is used, flexible insulated sound-attenuating duct can be used to reduce the transmitted sound into the space.

#### **A. Continuous Ventilation Fans (Surface-Mounted Fans)**

Continuously operated fans shall be rated at 1.0 sone or less. This applies to both whole-dwelling unit and local exhaust ventilation fans.

#### **B. Intermittent or Demand Controlled Fans (Surface-Mounted Fans)**

Intermittently operated dwelling unit ventilation fans shall be rated at a maximum of 1.0 sone. Demand-controlled local exhaust fans shall be rated at a maximum of 3.0 sones unless the maximum rated airflow is greater than 400 CFM.

ASHRAE Standard 62.2 extends the requirement for quiet fans to include range hoods and bath exhaust fans. Dwelling unit ventilation fans or systems that operate continuously must be -rated at 1.0 sone or less. However demand-controlled local exhaust fans must be 3.0 sones or less. Range hood exhaust fans must also be -rated at 3.0 sones or less at the minimum required speed of 100 CFM.

#### 4.6.10.3 Airflow Measurements and Airflow Ratings

§150.0(o)1Gv and §150.0(o)2All whole-dwelling unit ventilation systems must demonstrate compliance by direct measurement of airflow using a flow hood, flow grid, or other approved measuring device. HERS verification of whole-dwelling unit ventilation airflow is required for newly constructed buildings and existing buildings with additions greater than 1,000 square feet or an increase in the number of dwelling units.

There are two ways that the installer may demonstrate compliance with airflow requirements for local exhaust ventilation:

1. Test the ventilation system using an airflow measuring device after completion of the installation to confirm that the delivered ventilation airflow meets the requirement.
2. Conformance to a prescriptive requirement that the fan has a certified airflow rating that meets or exceeds the required ventilation airflow, and ventilation ducts that meet the prescriptive duct design requirements given in Table 4-18.

When using the prescriptive duct sizing table, the certified airflow rating of the fan must be based on tested performance at the 0.25 inches water column (w.c.) static pressure, except for when a vented range hood utilizes the capture efficiency rating to demonstrate compliance. When the capture efficiency rating is used, the airflow listed in the approved directory corresponding to the compliant capture efficiency rating point must be applied to Table 4-18.

The use of Table 4-18 is limited to ventilation systems that meets all of the following specifications.

1. Total duct length is less than or equal to 25 ft (8m);
2. Duct system has no more than three (3) elbows, and;
3. Duct system has exterior termination fitting with a hydraulic diameter greater than or equal to the minimum duct diameter and not less than the hydraulic diameter of the fan outlet.

The prescriptive duct design criteria given in Table 4-18 provide maximum exhaust duct lengths based on duct type and diameter. The higher the airflow, the larger in diameter the duct must be. Smooth duct can be used to manage longer duct runs. Interpolation and extrapolation of Table 4-18 are not allowed. For airflow rates not listed, use the next higher value. The table is not applicable for systems with airflow greater than 800 CFM at 62 Pa (0.25 inches water column) static pressure.

**Table 4-18: Prescriptive Ventilation System Duct Sizing (From Table 150.0-H)**

<b>Fan Airflow Rating, cfm at minimum static pressure<sup>f</sup> 0.25 in. water (L/s at minimum 62.5 Pa)</b>	≤50 (25)	≤80 (40)	≤100 (50)	≤125 (60)	≤150 (70)	≤175 (85)	≤200 (95)
<b>Minimum Duct Diameter, in. (mm) <sup>a,b</sup> For Rigid duct</b>	4 <sup>e</sup> (100)	5 (125)	5 (125)	6 (150)	6 (150)	7 (180)	7 (180)
<b>Minimum Duct Diameter, in. (mm) <sup>a,b</sup> For Flex duct<sup>c</sup></b>	4 (100)	5 (125)	6 (150)	6 (150)	7 (150)	7 (180)	8 (205)

<b>Fan Airflow Rating, cfm at minimum static pressure<sup>f</sup> 0.25 in. water (L/s at minimum 62.5 Pa)</b>	≤250 (120)	≤350 (165)	≤400 (190)	≤450 (210)	≤700 (330)	≤800 (380)
<b>Minimum Duct Diameter, in. (mm) <sup>a,b</sup> For Rigid duct</b>	8 (205)	9 (230)	10 (255)	10 (255)	12 (305)	12 <sup>d</sup> (305)
<b>Minimum Duct Diameter, in. (mm) <sup>a,b</sup> For Flex duct<sup>c</sup></b>	8 (205)	9 (230)	10 (255)	NP	NP	NP

Source: California Energy Commission

**Footnotes for Table 150.0-H [ASHRAE 62.2:Table 5-3]:**

- a. For noncircular ducts, calculate the diameter as four times the cross-sectional area divided by the perimeter.
- b. NP = application of the prescriptive table is not permitted for this scenario.
- c. Use of this table for verification of flex duct systems requires flex duct to be fully extended and any flex duct elbows to have a minimum bend radius to duct diameter ratio of 1.0.
- d. For this scenario, use of elbows is not permitted.
- e. For this scenario, 4 in. (100 mm) oval duct shall be permitted, provided the minor axis of the oval is greater than or equal to 3 in. (75 mm)
- f. When a vented range hood utilizes a capture efficiency rating to demonstrate compliance with 150.0(o)1Giiib, a static pressure greater than or equal to 0.25 in. of water at the rating point shall not be required, and the airflow listed in the approved directory corresponding to the compliant capture efficiency rating point shall be applied to Table 150.0-H for determining compliance.

**NOTE:** Authority: Sections 25213, 25218, 25218.5, 25402 and 25402.1, Public Resources Code. Reference: Sections 25007, 25008, 25218.5, 25310, 25402, 25402.1, 25402.4, 25402.5, 25402.8, and 25943, Public Resources Code.

---

**Example 4-32 – Prescriptive Duct Sizing****Question:**

I need to provide 75 CFM of continuous ventilation, which I plan to do using a central exhaust fan. I plan to connect the fan to a roof vent termination using flex duct. The duct will be about 8 feet long with no real elbows but some slight bends in the duct. What size duct do I need to use?

**Answer:**

From Table 150.0-H, using  $\leq 80$  CFM and the flex duct row, the minimum duct diameter is 5 inches.

**Example 4-33****Question:**

I will need a 100 CFM range hood. The ductwork is 35 feet long but requires only one elbow. What size flex duct do I need to use?

**Answer:**

The prescriptive duct sizing Table 150.0-H is limited to ductwork less than or equal to 25 feet, therefore it cannot be used here. In this case the airflow must be tested with an airflow measuring device to confirm that delivered airflow meets the required airflow.

---

**4.6.10.4 Exhaust Ducts**

From ASHRAE 62.2, Section 7.3, Exhaust Ducts.

7.3.1 Multiple Exhaust Fans Using One Duct. Exhaust fans in separate dwelling units shall not share a common exhaust duct. If more than one of the exhaust fans in a single dwelling unit shares a common exhaust duct, each fan shall be equipped with a backdraft damper to prevent the recirculation of exhaust air from one room to another through the exhaust ducting system.

7.3.2 Single Exhaust Fan Ducted to Multiple Inlets. Where exhaust inlets are commonly ducted across multiple dwelling units, one or more exhaust fans located downstream of the exhaust inlets shall be designed and intended to run continuously, or a system of one or more backdraft dampers shall be installed to isolate each dwelling unit from the common duct when the fan is not running.

ASHRAE Standard 62.2 limits how multiple exhaust fans can be connected through a shared duct system, intending to prevent air from moving between spaces through the exhaust ducts.

If two or more exhaust fans in a home share a duct, then each fan must be equipped with a backdraft damper so that air exhausted from one room cannot enter another area of the home. Exhaust fans in multiple dwelling units may not share a common duct.

#### 4.6.10.5 Supply Ducts

From ASHRAE 62.2, Section 7.4, Supply Ducts.

Where supply outlets are commonly ducted across multiple dwelling units, one or more supply fans located upstream of all the supply outlets shall be designed and intended to run continuously, or a system of one or more backdraft dampers shall be installed to isolate each dwelling unit from the common duct when the fan is not running.

Supply air outlets to more than one dwelling unit may be served by a single fan upstream of all the supply outlets if the fan is designed to run continuously or if each supply outlet is equipped with a backdraft damper to prevent cross-contamination when the fan is not running.

---

## 4.7 Alternative Systems

### 4.7.1 Hydronic Heating Systems

*Hydronic heating* is the use of hot water to distribute heat. Hydronic heating is discussed in this compliance manual as an “alternative system” because it is much less common in California than in other parts of the United States.

A hydronic heating system consists of a heat source, which may be a boiler, water heater, or heat pump, and a distribution system. There are three main types of hydronic distribution systems, and they may be used individually or in combination: baseboard convectors or radiators, air handlers, and radiant panel systems. Radiant panel surfaces can include floors, walls, and/or ceilings. Air handlers and radiant panels may be used for heating and cooling. Hot water air handlers may also be equipped with DX coils for cooling. The three distribution options are illustrated in Figure 4-32. Ducting is used only with air handlers.

#### 4.7.1.1 Mandatory Requirements

For hydronic heating systems without ducts, the mandatory measures cover pipe insulation, tank insulation, and boiler efficiency. For fan coils with ducted air distribution, the mandatory air distribution measures also apply. For combined hydronic systems, as described below, mandatory water heating requirements also apply to the water heating portion of the system.

##### A. Pipe and Tank Insulation



*§150.0(j) Insulation for Piping, and Tanks*

*§120.3 Requirements for Pipe Insulation*

The typical residential hydronic heating system operating between 105° and 140° F must have at least 1 inch (25 mm) of insulation on pipes less than 1 inch in diameter and 1.5 inch (38 mm) of insulation on pipes 1 inch or more in diameter. Systems operating between 141° and 200° F must have at least 1.5 inches of insulation on pipes less than 1.5 inches in diameter. For other temperatures and pipe insulation characteristics, see Table 4-5.

There are a few exceptions where insulation is not required:

1. Sections of pipes where they penetrate framing members
2. Pipes that provide the heat exchange surface for radiant heating and/or cooling
3. Piping in the attic that is covered by at least 4 inches (100 mm) of blown insulation on top
4. Piping installed within walls if all the requirements for Insulation Installation Quality are met (see Chapter 3 Building Envelope Requirements).

If the system includes an unfired hot water storage tank, then the tank must be either wrapped with R-12 insulation or insulated internally to at least R-16.

Piping used to deliver chilled water to panels or air handlers should be continuously insulated with closed-cell foam to prevent condensation damage.

**Figure 4-33: Hydronic Heating System Components**

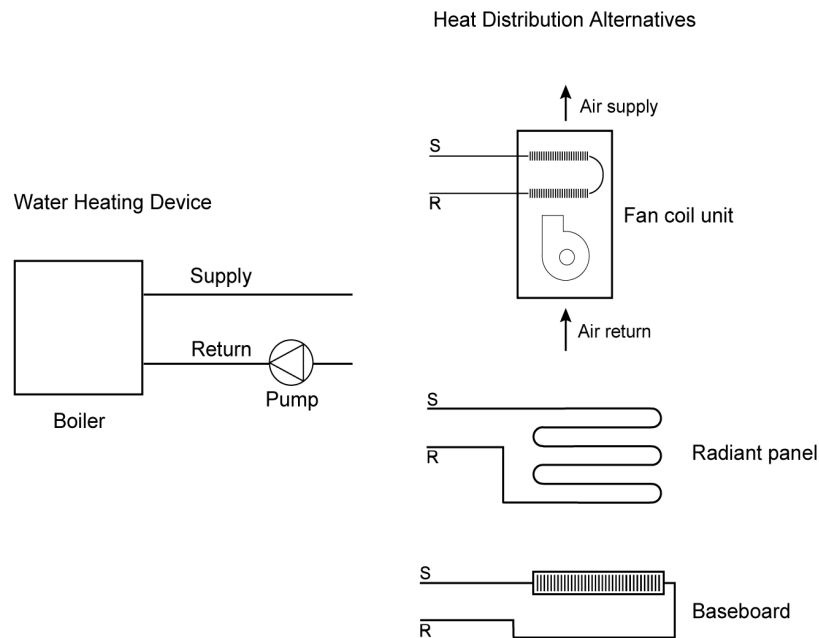

Source: Richard Heath & Associates/Pacific Gas and Electric Company

**Figure 4-34: Combined Hydronic System With Water Heater as Heat Source**

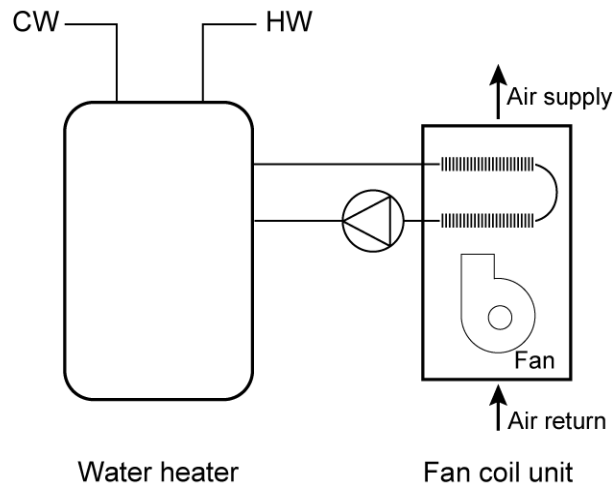

Source: Richard Heath & Associates/Pacific Gas and Electric Company

For pipes in hydronic heating systems that operate at pressure greater than 15 psi, the requirements of §120.3 apply. These are the same requirements that apply to nonresidential piping systems.

## B. Equipment Efficiency

Gas or oil boilers used for residential space heating (typically less than 300,000 Btu/h capacity) must be rated with an AFUE of 80 percent or greater. (See *Appliance Efficiency Regulations, Title 20* for minimum efficiencies of other heating equipment.) A gas or oil water heater may also be used as a dedicated source for space heating. Other hot water sources, including heat pumps or electric resistance water heaters, are not allowed for use in dedicated space-heating systems. Therefore, some water heaters may be used for space heating only if used as part of a combined hydronic system, as described below. In that case, the mandatory water heater requirements apply.

There are no minimum efficiency requirements for heat pumps that produce hot or chilled water, but compliance calculations must use information listed in the Energy Commission's [Title 20 appliance database](#) under the category "Central Heat Pumps" and Appliance Type "Heat Pump Water Heating Packages", including compressor speed.

<https://cacertappliances.energy.ca.gov/Pages/ApplianceSearch.aspx>

Thermostat requirements also apply to hydronic systems, as described in Section 4.5.1.

**4.7.1.2 Prescriptive Requirements**

There are no specific prescriptive requirements that apply to hydronic systems. However, if the system has a fan coil with ducted air distribution, the relevant prescriptive requirements apply, including duct insulation and duct sealing.

**4.7.1.3 Performance Compliance Options**

Credit for choosing a hydronic heating system is possible using the performance compliance method. The standard design is assumed to have a heat pump in climate zones 3, 4, 13, and 14 and a gas furnace in all other climate zones. In all cases, the system is of minimum efficiency rating with a ducted air distribution system. Therefore, hydronic systems without ducts can take credit for avoiding duct leakage penalties. In addition, minimizing the amount of pipe outside conditioned space will provide some savings. Hydronic heating and cooling compliance calculations are described in the *Residential ACM Manual*.

If the proposed hydronic system includes ducted air distribution, then the associated compliance options described earlier in this chapter may apply, such as improved airflow (if there is air conditioning) and supply duct location.

A “combined hydronic” system is another compliance option that is possible when using the performance method. *Combined hydronic heating* refers to the use of a single water heating device as the heat source for space and domestic hot water heating.

Combined hydronic systems may use either a boiler (as in the figure below), heat pump, or a water heater as a heat source. The boiler heats domestic water by circulating hot water through a heat exchanger in an indirect-fired water heater. The water heater provides domestic hot water as usual.

**Figure 4-35: Combined Hydronic System With Boiler and Indirect Fired Water Heater**

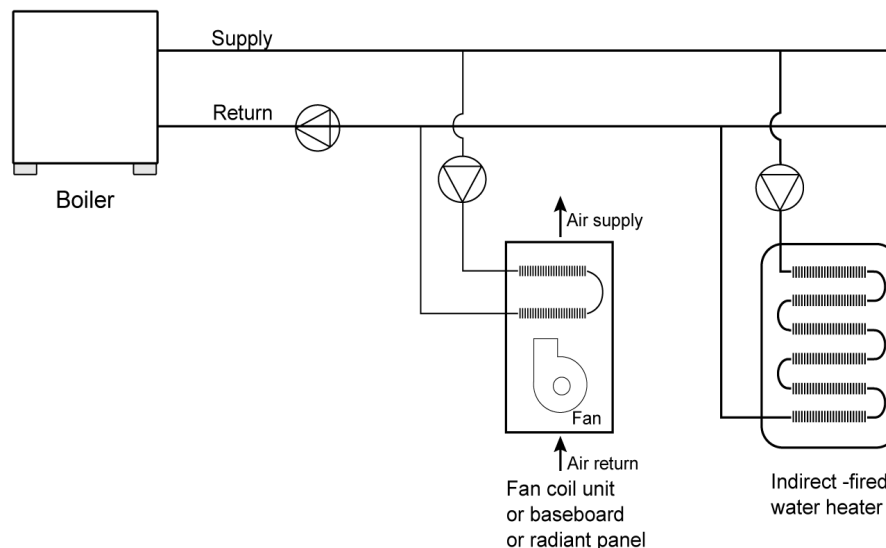

Source: Richard Heath & Associates/Pacific Gas and Electric Company

Space heating is accomplished by circulating water from the heat source through the space heating delivery system. Sometimes a heat exchanger is used to isolate potable water from the water circulated through the delivery system. Some water heaters have built-in heat exchangers for this purpose.

For compliance calculations, the water-heating function of a combined hydronic system is analyzed for water-heating performance as if the space-heating function were separate. For the space-heating function, an “effective” AFUE or HSPF rating is calculated. These calculations are performed automatically by the compliance software.

### 4.7.2 Radiant Floor System

*§110.8(g) and Table 118.0-A*

Radiant floor systems, using either hydronic tubing or electric cable, must meet mandatory insulation measures. (See below.) Radiant floors may take one of several forms. Tubing or electric elements for radiant floor systems may be:

1. Embedded in a concrete floor slab.
2. Installed over the top of a wood subfloor and covered with a concrete topping.
3. Installed over the top of a wood subfloor in between wood furring strips.
4. Installed on the underside surface of a wood subfloor

In the latter two types of installations, aluminum fins are typically installed to spread the heat evenly over the floor surface and to reduce the temperature of the water as required. All hydronic systems use one or more pumps to circulate hot water. Pumps are controlled directly or indirectly by thermostats or by special outdoor reset controls. When concrete slabs are heated by radiant tubing or cables, one of the insulation methods listed below must be complied with to prevent excessive heat loss from the slab edge.

**Table 4-19: Slab Insulation Requirements for Heated Slabs**

<b>Location of Insulation</b>	<b>Orientation of Insulation</b>	<b>Installation Criteria</b>	<b>Climate Zone</b>	<b>Insulation R-Value</b>
Outside edge of heated slab, either inside or outside the	Vertical	From the level of the top of the slab, down 16 inches or to the frost line, whichever is greater. Insulation may stop at the top of the footing where	1-15	5

<b>Location of Insulation</b>	<b>Orientation of Insulation</b>	<b>Installation Criteria</b>	<b>Climate Zone</b>	<b>Insulation R-Value</b>
foundation wall		<p>this is less than the required depth.</p> <p>For below-grade slabs, vertical insulation shall be extended from the top of the foundation wall to the bottom of the foundation (or the top of the footing) or frost line, whichever is greater.</p>		
Outside edge of heated slab, either inside or outside the foundation wall	Vertical	<p>From the level of the top of the slab, down 16 inches or to the frost line, whichever is greater. Insulation may stop at the top of the footing where this is less than the required depth.</p> <p>For below-grade slabs, vertical insulation shall be extended from the top of the foundation wall to the bottom of the foundation (or the top of the footing) or frost line, whichever is greater.</p>	16	10
Outside edge of heated slab, either inside or outside the foundation wall	Vertical	<p>From the level of the top of the slab, down 16 inches or to the frost line, whichever is greater. Insulation may stop at the top of the footing where this is less than the required depth.</p> <p>For below-grade slabs, vertical insulation shall be extended from the top of the foundation wall to the</p>	1-15	5

Location of Insulation	Orientation of Insulation	Installation Criteria	Climate Zone	Insulation R-Value
		bottom of the foundation (or the top of the footing) or frost line, whichever is greater.		
Between heated slab and outside foundation wall	Vertical and Horizontal	Vertical insulation from the top of the slab at the inside edge of the outside wall down to the top of the horizontal insulation. Horizontal insulation from the outside edge of the vertical insulation extending 4 feet toward the center of the slab in a direction normal to the outside of the building in the plan view.	16	10 vertical and 7 horizontal

Source: 2022 Energy Code Table 110.8-A

The required insulation value for each of these insulating methods is shown in Table 4-19.

Slab edge insulation applied to basement or retaining walls (with heated slab below grade) must be installed so that insulation starts at or above ground level and extends down to the bottom of the foundation or to the frost line, whichever is greater.

When using the performance compliance method with slab-on-grade construction, the standard design includes slab edge insulation as described above using the F-factors in JA4, Table 4.4.8.

When tubing or heating cables are set into a lightweight concrete topping slab laid over a raised floor, the edges of the radiant panel must not extend beyond the inside surface of insulated walls, and underside insulation must meet the mandatory minimum R-value for wood floor assemblies.

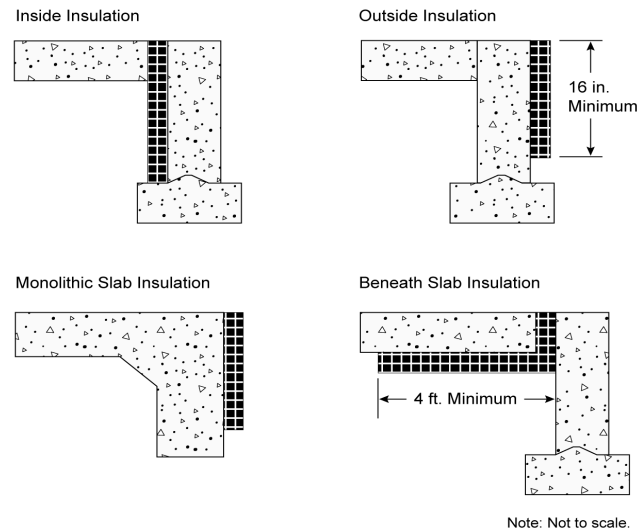
**Figure 4-36: Heated Slab-On-Grade Floor Insulation Options**

Source: California Energy Commission

Local conditions (such as a high water table) may require special insulation treatment to achieve satisfactory system performance and efficiency. To determine the need for additional insulation, follow the recommendations of the manufacturer of the hydronic tubing or heating element being installed. Where there is any danger of termite infestation, install termite barriers to prevent hidden access for insects from the ground to the building framing. Termite barrier flashing should be embedded into the concrete.

In addition to the insulation R-value requirements, §110.8(g)1 also sets mandatory measures related to moisture absorption properties of the insulation and protection of the insulation from physical damage or pest intrusion.



---

**Example 4-34****Question:**

My client wants a dedicated hydronic-heating system (space heating only), but a few things are unclear: (1) What piping insulation is required? (2) Can I use any compliance approach? (3) Do I have to insulate the slab with slab edge insulation? (4) What special documentation must be submitted for this system type?

**Answer:**

(1) The supply lines not installed within a concrete radiant floor must be insulated in accordance with §150.0(j)2— Systems operating between 105° and 140° F must have at least 1 inch of insulation on pipes less than 1 inch in diameter, and 1.5 inches of insulation on pipes between 1 inch and less than 1.5 inches in diameter. Systems operating between 141° and 200° F must have at least 1.5 inches of insulation on pipes less than 1.5 inches in diameter.

(2) You can use any compliance approach, but the boiler must meet the mandatory efficiency 80 percent AFUE.

(3) The slab edge insulation shown in

Table 4-19 is required only when the distribution system is a slab-on-grade radiant floor system (pipes in the slab). When this is the case, the insulation values shown are mandatory measures (no modeling or credit).

(4) No special documentation is required.

**Example 4-35****Question:**

What are the slab edge insulation requirements for a hydronic-heating system with the hot water pipes in the slab?

**Answer:**

The requirements for slab edge insulation can be found in §110.8 and §150.0(l).

Material and installation specifications are as follows:

1. Insulation values as shown in
  2. Table 4-19
  3. Protected from physical damage and ultraviolet light deterioration
  4. Water absorption rate no greater than 0.3 percent (ASTM-C272)
  5. Water vapor permeance no greater than 2.0 per inch (ASTM-E96-14).
-

### 4.7.3 Evaporative Cooling

Evaporative coolers cool a building by passing outdoor air through a wetted evaporative medium (direct evaporative cooler), by indirect cooling through a nonporous heat exchanger separating evaporatively cooled secondary air from outdoor air, or by a system that combines an indirect heat exchanger with a downstream direct evaporative process. Although direct coolers are most common, the indirect and indirect-direct systems offer generally lower supply air temperatures with less moisture introduced to the indoor space. For the Energy Code, performance credit is allowed only for indirect and indirect-direct evaporative cooling systems. All coolers receiving credits within the *ACM Manual* must be listed in the CEC's [Title 20 Evaporative Cooler appliance database](https://cacertappliances.energy.ca.gov/Pages/ApplianceSearch.aspx) at <https://cacertappliances.energy.ca.gov/Pages/ApplianceSearch.aspx>.

Evaporative coolers may be used with any compliance approach. In the prescriptive compliance approach, all evaporative coolers are treated as a minimum efficiency 13.0 SEER air conditioner.

In the performance approach, the compliance software uses an hourly model based on unit effectiveness, supply airflow, and power to determine the magnitude of the credit based on climate conditions and unit sizing relative to the loads. Typical cooling budget credits are 20-30 percent, depending upon these factors.

The evaporative cooling system must meet the following requirements to receive credit based on the hourly performance method described above. Direct coolers, as well as indirect and indirect-direct coolers not meeting these criteria, shall be modeled as a minimum efficiency (13.0 SEER) central air conditioner.

1. The equipment manufacturer shall certify to the Energy Commission that water use does not exceed 7.5 gallons per ton hour based on the Title 20 Appliance Efficiency Regulations testing criteria.
2. Equipment shall be permanently installed (no window or portable units).
3. Installation shall provide for automatic relief of supply air from the house with maximum air velocity through the relief dampers not exceeding 800 feet per minute (at the Title 20 rated airflow). Pressure relief dampers and ductwork shall be distributed to provide adequate airflow through all habitable rooms. For installations with an attic, ceiling dampers shall be installed to relieve air into the attic and then outside through attic vents. For installations without an attic, sidewall relief dampers are acceptable.
4. To minimize water consumption, bleed systems are not allowed.
5. A water quality management system (either "pump down" or conductivity sensor) is required. "Pump down" systems can either be integral to the evaporative cooler or they can be accessories that operate on a timed interval. The time interval between pumps shall be set to a minimum of 6 hours of

cooler operation. Longer intervals are encouraged if local water quality allows. Automatic systems that use conductivity sensors provide the best water efficiency compared to a timed pump down system. These sensors monitor the water quality and don't unnecessarily drain the water based on elapsed time.

6. Automatic thermostats are required. Manual on/off controls are not allowed.
7. If the evaporative cooler duct system is shared with a heating and/or cooling system, the installed duct system shall employ backdraft dampers at the evaporative cooler supply.
8. The installing contractor must provide a winter closure device that substantially blocks outdoor air from entering the indoor space.
9. The size of the water inlet connection at the evaporative cooler shall not exceed 3/8 inch.
10. Unless prohibited by local code, the sump overflow line shall not be directly connected to a drain and shall terminate in a location that is normally visible to the building occupants.

---

#### Example 4-36

**Question:**

How are applications with vapor compression cooling systems and evaporative cooling systems handled?

**Answer:**

In situations where evaporative cooling system(s) and vapor compression system(s) are installed in a house, the size of the evaporative cooler will dictate the magnitude of the credit. The performance approach will ensure that an evaporative cooler sized to meet most of the cooling loads will generate a higher credit than one sized to meet a fraction of the design cooling load.

#### Example 4-37

**Question:**

How do you model multiple evaporative coolers on one house?

**Answer:**

In situations with multiple evaporative coolers, effectiveness inputs should be averaged, and airflow and power inputs should be totaled. Performance characteristics of each piece of equipment should be listed on the compliance forms.

---

### 4.7.4 Ground-Source Heat Pumps

**Table 4-20 – Standards for Ground Water-Source and Ground-Source Heat Pumps Manufactured on or After October 29, 2003**

<b>Appliance</b>	<b>Rating Condition</b>	<b>Minimum Standard</b>
Ground water-source heat pumps (cooling)	59° F entering water temperature	16.2 EER
Ground water-source heat pumps (heating)	50° F entering water temperature	3.6 COP
Ground-source heat pumps (cooling)	77° F entering brine temperature	13.4 EER
Ground-source heat pumps (heating)	32° F entering brine temperature	3.1 COP

Source: Section 1605.3 Table C-7 of the 2015 California Appliance Efficiency Regulations

A geothermal or ground-source heat pump uses the earth as a source of energy when heating the home and as a heat sink for energy when cooling. Some systems pump water from an aquifer in the ground and return the water to the ground after exchanging heat with the water. A few systems use refrigerant directly in a loop of piping buried in the ground. Those heat pumps that either use a water loop or pump water from an aquifer have efficiency test methods that are accepted by the Energy Commission.

The mandatory minimum efficiencies for ground water-source heat pumps shown in Table 4-17 are certified to the Energy Commission by the manufacturer and are expressed in terms of coefficient of performance (COP) for heating and EER for cooling.

Verify that the system will meet local code conditions before choosing this type of system to comply with the Energy Code.

#### **4.7.5 Solar Space Heating**

Solar space-heating systems are not recognized within either the prescriptive packages or the performance compliance method.

#### **4.7.6 Wood Space Heating**

The Energy Commission's exceptional method for wood heaters with any type of backup heating is available in areas where natural gas is not available. If the required eligibility criteria are met, a building with one or more wood heaters may be shown to comply with the Energy Code using either the prescriptive or performance approaches as described below.

#### 4.7.6.1 Prescriptive Approach

The building envelope conservation measures of the component package must be installed. The overall heating system efficiency (wood stove plus backup system) must comply with the prescriptive requirements.

#### 4.7.6.2 Performance Approach

A computer compliance method may be used by modeling wood heat, which simulates an 80 percent AFUE central furnace with ducts that meet prescriptive requirements.

#### 4.7.6.3 Wood Heater Qualification Criteria

The Energy Code establishes exceptional method guidelines for the use of wood heaters. If all the criteria for the wood heat exceptional method are not met, a backup heating system must be included in the compliance calculations as the primary heat source.

The building department having jurisdiction must determine that natural gas is not available.

*Note:* Liquefied petroleum gas, or propane, is not considered natural gas.

The following eligibility criteria apply:

1. The local or regional air quality authority must determine that its authorization of this exceptional method is consistent with state and regional ambient air quality requirements according to Sections 39000 to 42708 of the California Health and Safety Code.
2. The wood heater must be installed in a manner that meets the requirements of all applicable health and safety codes, including, but not limited to, applicable requirements for maintaining indoor air quality.
3. The wood heater must meet the EPA definition of a wood heater as defined in Title 40, Part 60, Subpart AAA of the Code of Federal Regulations (40CFR60 Subpart AAA) (See below.)
4. The performance of the wood heater must be certified by a nationally recognized agency and approved by the building department having jurisdiction to meet the performance standards of the EPA.
5. The rated output of the wood heater must be at least 60 percent of the design heating load, using calculation methods and design conditions as specified in §150(h).
6. At the discretion of the local enforcement agency, a backup heating system may be required and designed to provide all or part of the design heating load, using calculation methods and design conditions as specified in §150(h).

7. The wood heater must be located such that transfer of heat from the wood heater is effectively distributed throughout the entire residential dwelling unit, or it must be used in conjunction with a mechanical means of providing heat distribution throughout the dwelling.
8. Habitable rooms separated from the wood heater by one free opening of less than 15 ft<sup>2</sup> or two or more doors must be provided with a positive heat distribution system, such as a thermostatically controlled fan system. Habitable rooms do not include closets or bathrooms.
9. Wood heaters on a lower level are considered to heat rooms on the next level up, provided they are not separated by two or more doors.
10. The wood heater must be installed according to manufacturer and local enforcement agency specifications and must include instructions for homeowners that describe safe operation.
11. The local enforcement agency may require documentation that demonstrates that a particular wood heater meets all these requirements.

Federal regulation 40CFR60 Subpart AAA includes minimum criteria for wood heaters established by the U.S. EPA. These criteria define a wood heater as an enclosed, wood-burning appliance capable of and intended for space heating or domestic water heating that meets all the following criteria:

1. An air-to-fuel ratio averaging less than 35 to 1
2. A firebox volume less than 20 ft<sup>3</sup>.
3. A minimum burn rate less than 5 kilogram/hour (11.0 lbs/hr)
4. A maximum weight of less than 800 kilograms (1,760 lbs)
5. The federal rules explicitly exclude furnaces, boilers, cook stoves, and open masonry fireplaces constructed on site, but include wood-heater inserts.

---

#### Example 4-38

**Question:**

Are pellet stoves treated the same as wood stoves for compliance with the Energy Code?

**Answer:**

Yes.

#### Example 4-39

**Question:** If a wood stove is installed in a wall, does it have to meet the fireplace requirements of §150(e)?

**Answer:**

No. A wood stove that meets EPA certification requirements does not have to meet any requirements applicable to fireplaces.

---

### 4.7.7 Gas Appliances

#### *§110.5 Pilot Lights*

Pilot lights are prohibited in fan-type central furnaces, pool heaters, spa heaters, and natural gas indoor and outdoor fireplaces.

Household cooking appliances are also prohibited from having a pilot light unless there is no electrical supply voltage connection and each pilot consumes less than 150 Btu/h.

For requirements related to installation of fireplaces, decorative gas appliances, and gas logs, see Chapter 3 of this manual.

### 4.7.8 Evaporatively Cooled Condensers

*Evaporatively cooled condenser air conditioners* are a type of air-conditioning system that can provide significant space-cooling savings, especially in hot, dry climates. The equipment minimal efficiencies are determined according to federal test procedures. The efficiencies of these air conditioners are reported in terms of energy efficiency rating (EER).

If credit is taken for a high EER, field verification by a HERS Rater is required. Other HERS-verified measures are also required, including duct sealing, airflow, fan efficacy, and refrigerant charge or fault indicator display.

Besides the HERS verification, there are additional special requirements for evaporatively cooled condensing air conditioners. These include that the manufacturer provide certification that water use is limited to no more than 0.15 gallon per minute per ton of capacity and that the supply line be no larger than ¼-inch in diameter. For a listing of all the requirements for evaporatively cooled condensing air conditioners, see the CF2R compliance form.

### 4.7.9 Variable Capacity Heat Pump Systems

Several manufacturers offer variable capacity mini-split or multi-split heat pump equipment that may or may not use air distribution ducts to heat or cool spaces. These systems provide advanced controls and multispeed compressors for optimizing performance through a wide range of conditioning loads.

These systems are required to be modeled as minimally efficient systems unless the variable capacity heat pump (VCHP) compliance credit is taken. This option is available to provide credit for systems meeting the eligibility requirements published in the 2022 Residential Appendices RA3.4.4.3. The credit can be applied through a CEC-approved modeling software by selecting the VCHP compliance option for the

HVAC system type. The Certificate of Compliance will indicate when a space conditioning system requires verification of the VCHP compliance option eligibility requirements. A system that does not meet the eligibility requirements upon verification will not be eligible to claim the VCHP performance compliance credit for the specified space conditioning system.

Compliance with the mandatory duct system sealing and leakage (Section 150.0(m)11) and fan airflow rate and fan efficacy testing (Section 150.0(m)13) are not required for systems that use this VCHP performance compliance option. However, there are requirements to verify that VCHP system indoor unit ducts are located entirely in conditioned space that are specified as eligibility requirements for this compliance option. There are also requirements for verification of minimum airflow rates for VCHP system indoor units that are specified as eligibility requirements for this compliance option.

Additional verification requirements apply depending on the system type and credit taken, see below.

- Low-Static Certification for Ducted Systems
- Non-Continuous Indoor Unit Fan Operation
- Refrigerant Charge Verification
- Ducts Located Entirely in Conditioned Space
- Indoor Units Located Entirely in Conditioned Space
- Supply to All Habitable Spaces
- Wall-Mounted Thermostat
- Space-Conditioning System Airflow
- Air Filter Sizing
- Air Filter Pressure Drop Rating

Default indoor unit fan configuration settings may require modification in order for the installed fan airflow to meet the required rate. The manufacturer's product documentation should provide direction for configuring the indoor unit fan for operation at airflow rates equal to or greater than the minimum rates required for compliance. The [list of low-static ducted VCHP systems certified to the Energy Commission](#) including the manufacturer's product documentation can be found at:

<https://www.energy.ca.gov/rules-and-regulations/building-energy-efficiency/manufacture-certification-building-equipment-2>



### 4.7.10 Ventilation Cooling

*Ventilation cooling* is differentiated from the mechanical ventilation provided to maintain adequate indoor air quality, in that the primary focus is to bring in higher volumes of cool outdoor air (if available) to cool the dwelling unit to reduce the use of conventional vapor compression air conditioning. Ventilation cooling systems generally operate during summer evenings and nights when cooler outdoor air is available. The cooler outdoor air ventilation reduces indoor air temperatures during the evening and nighttime hours, and in the process cools the building interior thermal mass, which may offset or eliminate the next-day cooling loads of the dwelling. Ventilation cooling systems may cool the dwelling to temperatures that are below the normal air conditioner set point, which may improve the effectiveness of the next-day cooling load offset. The effectiveness of ventilation cooling depends upon the climate conditions, thermal envelope, and how much indoor temperature variation the occupant will tolerate.

Figure 4-37 compares cooling energy use over a day for two identical houses, one with and one without ventilation cooling, and illustrates how ventilation cooling can offset most of the air-conditioning energy by use of a relatively small amount of off-peak ventilation fan operation.

**Figure 4-37: Diurnal Temperature Variation and Ventilation Cooling**

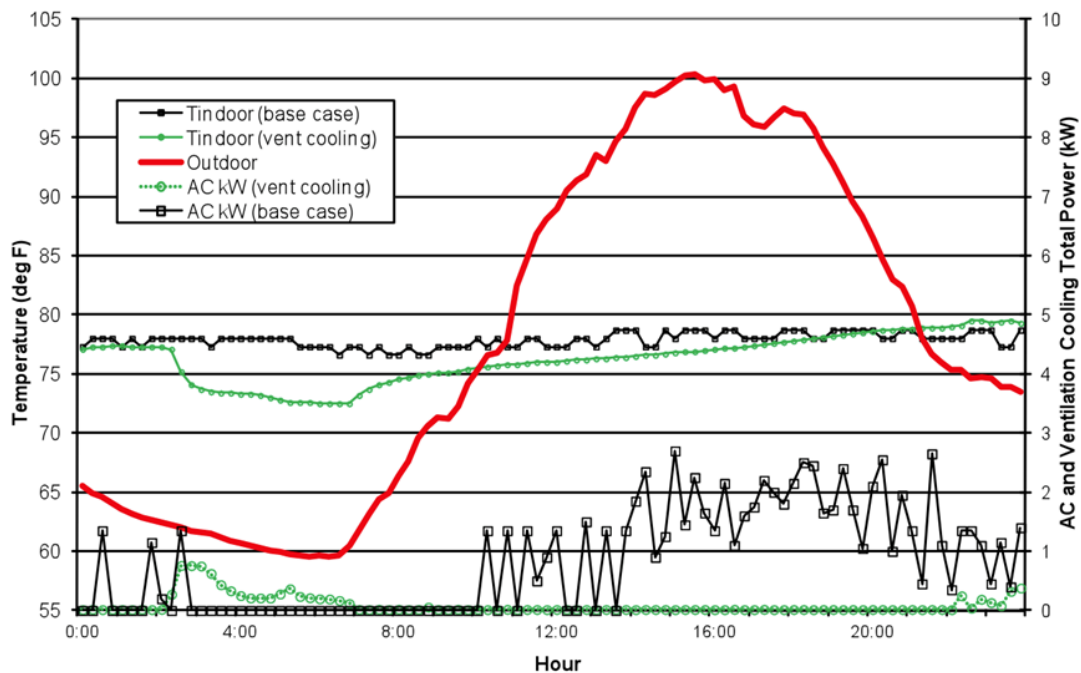

Source: California Energy Commission

#### 4.7.10.1 Whole-House Fans

The simplest form of ventilation cooling is a whole-house fan (WHF), which draws cooler outdoor air through open windows, exhausts the warmer air into the attic, and then expels the air outside through attic vents.

Traditional whole-house fans have a simple barometric damper (Figure 4-38) and either a belt-driven or direct-drive motor driving a prop fan. Figure 4-39 shows the damper open with the fan immediately above.

Figure 4-40 shows a similar product that moves less air but provides an insulated damper with a better leakage seal between the attic and conditioned space. These units are generally designed to fit between standard rafter spacing, simplifying retrofit installations.

Finally, Figure 4-41 shows a remote whole-house fan design that removes the fan farther from indoor space, reducing noise during operation.

WHFs cool a dwelling space most effectively when all windows throughout the house are opened only enough to produce a fairly uniform airflow into all rooms throughout the dwelling while not restricting the WHF total airflow. This results in the greatest interaction of the cool air with the interior mass throughout the dwelling, providing the greatest amount of stored cooling. Running the fan all night long increases the effectiveness of the next-day cooling offset by more fully “charging” the thermal mass. Noise can be reduced through either use of a variable-speed control or installation of a multispeed fan, allowing low-speed nighttime operation.

Security concerns may arise if windows are left open at night, but most window products can be secured if they are only partially open, thus providing the minimum open area for air to enter the room but preventing unauthorized entry from outside the dwelling.

Homeowners who have sensitivities to particulate matter in the outdoor air should consider that dust and allergens present in the outdoor air will easily enter the dwelling through the open windows during operation of a WHF.

The WHFs used to comply with the Energy Code must be listed in the HVI Certified Products Directory.

**Figure 4-38: Whole-House Fan With Barometric Damper**



Source: California Energy Commission

**Figure 4-39: Open Barometric Damper With Fan Above**

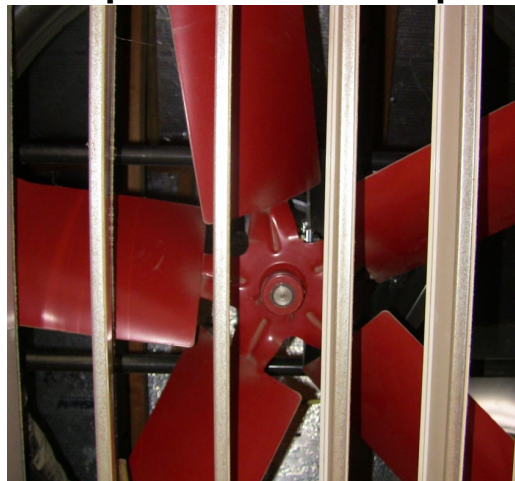

Source: California Energy Commission

**Figure 4-40: Insulated Whole-House Fan With Damper Actuation**



Source: California Energy Commission

**Figure 4-41:** *Ducted Remote Whole-House Fan*

Source: California Energy Commission

#### 4.7.10.2 Central Fan Ventilation Cooling Systems

Another type of ventilation cooling system, the central fan ventilation cooling system (CFVCS) uses an automatically controlled outside air damper and the HVAC system fan or other fan to draw outside air through a large outdoor air vent and distributes the cool outdoor air through the HVAC system ductwork. Warm indoor air is then expelled into the attic through the same damper.

Primary advantages of this system include filtration of outside air, elimination of the need to open windows (improved security), and automatic sensing of the moment when the outdoor air temperature falls below the indoor temperature. A disadvantage of central fan systems is that they typically move less air and consume more energy per CFM as compared to a whole-house fan because of the more restrictive duct systems.

Figure 4-42 shows the airflow path through a CFVCS when the system is not operating to provide ventilation cooling (return air mode). In this mode, the system performs the same as a conventional central space-conditioning system, drawing the return air from the conditioned space, through the heating/cooling coils, then back to the conditioned space.

**Figure 4-42: Central Fan Ventilation Cooling System (Return Air Mode)**

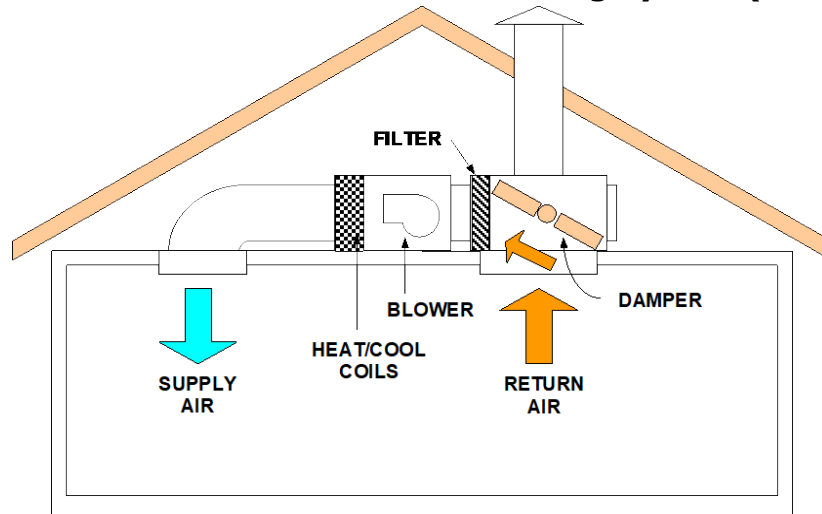

Source: California Energy Commission

Figure 4-43 shows the airflow paths when the system is operating to provide ventilation cooling (outdoor air mode). In this mode, the damper changes position and draws outdoor air through the outdoor air intake vent, through the air handler, and then to the conditioned space. During outdoor air mode, the cooling/heating coils are not operated, and the damper allows indoor air to pass into the attic, then back to outdoors through the attic vents.

**Figure 4-43: Central Fan Ventilation Cooling System (Outdoor Air Mode)**

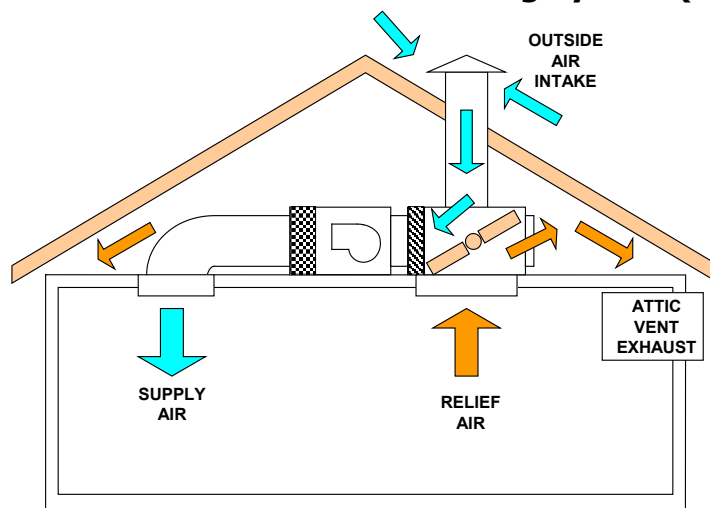

Source: California Energy Commission

**Figure 4-44: Sample Rooftop Air Intake**

Source: California Energy Commission

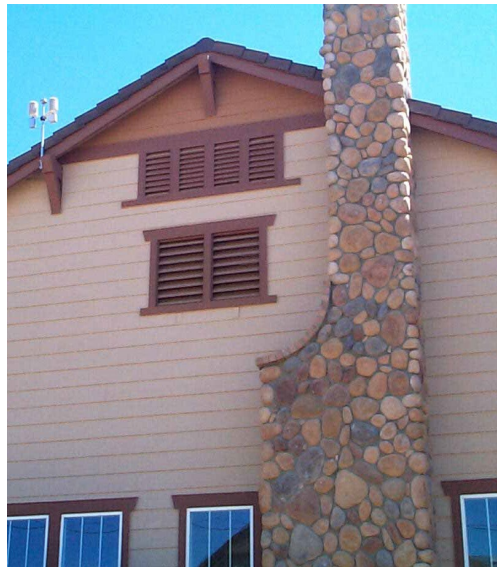
**Figure 4-45: Sample Gable End Air Intake (Lower Set of Vents)**

Source: California Energy Commission

CFVCSs may use a variable-speed motor with a fan-speed control that responds to outdoor temperature conditions and indoor comfort settings, which may improve energy savings compared to fixed-speed CFVCSs.

#### 4.7.10.3 **Prescriptive Requirements**

Component packages specify a WHF as a prescriptive requirement for single-family newly constructed buildings in Climate Zones 8 through 14. The WHF, or CFVCS, must meet the eligibility criteria specified below to meet the prescriptive requirement.

New dwelling units with a conditioned floor area of 500 square feet and additions of 1,000 ft<sup>2</sup> or less are exempt from the whole-house fan prescriptive requirements.

#### 4.7.10.3.1 Eligibility Criteria for Whole-House Fans

*§150.1(c)12*

1. Where atmospherically vented combustion appliances or solid-fuel burning appliances are located inside the pressure boundary, the operation of the whole-house fan must be considered in determining the adequacy of providing combustion air and prevention of back-drafting, which may cause toxic combustion products to enter conditioned space of the dwelling.
2. WHFs used to comply with the Energy Code must be listed in the HVI Certified Products Directory.
3. To meet the prescriptive requirement, the installed WHF(s) must have a listed airflow of at least 1.5 CFM/ft<sup>2</sup> of conditioned floor area. The house must have a minimum attic net free vent area to outdoors of one square foot per 750 CFM of installed rated airflow. See Table 4-21 and Table 4-22 for net free ventilation area requirements based on the square footage of the house.
4. Homeowners who have WHFs installed must be provided with a one-page "How to operate your whole house fan" informational sheet.

#### A. Eligibility Criteria for Central Fan Ventilation Cooling Systems

CFVCS may be approved for use for compliance credits as "fixed-speed" systems or as "variable speed" systems. The Energy Commission must review submittals from manufacturer applicants and determine whether the system meets the qualifying criteria:

When applying for approval for either fixed speed or variable speed systems, the manufacturer must provide documentation to demonstrate the system meets the criteria listed in paragraphs 1, 2, and 3 below

1. CFVCS must meet the applicable duct leakage requirements with the system operating in return air mode (Figure 4-42).
2. CFVCS must be HERS verified for airflow (CFM) and fan efficacy (w/CFM), demonstrating an efficacy of no more than 0.45 watts/CFM for furnaces, 0.58 W/CFM for heat pumps, and 0.62W/CFM for small duct, high velocity systems.
3. In addition to sensing temperature at the thermostat, the CFVCS must have an outdoor temperature sensor to initiate and terminate ventilation cooling operation and a means to detect damper failure.

When applying for approval as a variable speed system, the manufacturer must also provide the documentation described in paragraphs 4, 5, and 6 below.

4. The installed fan motor is a variable-speed motor.

5. The motor is controlled in ventilation cooling mode to vary in a continuous range between full air flow (100 percent) and a minimum airflow of no more than 25 percent of full airflow.
6. The manufacturer must provide written documentation that describes how its control strategy is implemented, how the ventilation cooling fan speed is controlled, and how ventilation cooling rates are determined. The ventilation cooling rate calculation must occur within a 24-hour interval or less to ensure that the system responds in a timely manner to changes in weather patterns.

Table 4-21 shows example conversions for the calculated net free vent area (NFVA) for a range of whole-house fan airflow levels. Instead of using the table, one can calculate the NFVA by dividing the listed CFM by 750.

**Table 4-21: Sample NFVA Calculation**

CEC Listed Airflow (CFM)	Minimum Attic NFVA (ft <sup>2</sup> )
2000	2.7
3000	4
4000	5.3
5000	6.7
6000	8
7000	9.3

Source: California Energy Commission

Since attic vents present some level of airflow restriction, use the appropriate screen and louver reduction factor from Table 4-22.

**Table 4-22: Attic Vent Airflow Reduction Factors**

Vent Type	Reduction Factor
¼" screen (hardware cloth)	0.90
¼" screen with metal louvers	0.75
¼" screen with wood louvers	0.25
Insect screen (mesh under ¼")	0.50
Insect screen with metal louvers	0.50
¼" screen with wood louvers	0.25

Source: California Energy Commission



---

**Example 4-40**

Required vent area = Minimum Attic NFVA (Table 4-18) ÷ Reduction Factor

A 3,000 CFM fan is selected from the Energy Commission Appliance Database. The builder plans to use vents with ¼" screen with metal louvers.

**Answer**

The minimum required vent area is =  $4.0 \div 0.90 = 4.4 \text{ ft}^2$

**Example 4-41 – Ventilation Cooling****Question:**

I am building a 2,350 ft<sup>2</sup> house in Climate Zone 8. Do I need to install a whole-house fan or central fan ventilation system?

**Answer:**

Yes, if you are complying prescriptively.

No, if you are complying using the performance method and no whole-house fan was modeled.

Whole-house fans are a prescriptive requirement in Climate Zones 8-14, meaning that they are not mandatory, although they define the prescriptive compliance level. If you decide to install a whole-house fan to meet the prescriptive requirement, you should select a fan from the Energy Commission Appliance Database. The prescriptive requirement specifies a minimum airflow of 1.5 CFM/ft<sup>2</sup> (3,525 CFM for the proposed house) and 1 ft<sup>2</sup> of attic net free ventilation area per 750 CFM of airflow (4.7 ft<sup>2</sup> for a 3,525 CFM fan).

**Example 4-42****Question:**

Why do I need to provide attic ventilation area for a whole-house fan?

**Answer:**

Whole-house fans move a lot of air from inside the dwelling unit, all of which is exhausted to the attic. Without sufficient attic relief to the outdoors, the fan will move less air.

**Example 4-43****Question:**

What are the advantages and disadvantages of whole-house fans relative to central fan ventilation cooling systems?

**Answer:**

Whole-house fans are relatively inexpensive; both in first cost and operating cost and are highly effective if used properly in the right climate. They move much more air than central fan systems, which must deliver air through the duct system. Whole-house fans may be noisy, require user operation to open windows, turn on and off, bring in dust and allergens from outside, and potentially reduce home security if windows are left open throughout the night. Central fan systems are more expensive and generally move less air, but provide totally automated operation, independent of whether the occupant is home. Windows can remain shut, and all outdoor air is filtered. Some central fan systems may also be configured to provide ventilation that complies with the whole-dwelling indoor air quality requirements in Section 150.0(o). Review product literature to determine if available products meet the Energy Commission's fresh air ventilation requirements.

Example 4-44

**Question:**

A two-story home with 2,500 sf of conditioned space and an attic is located in Climate Zone 10. Is a whole-house fan required? Does this affect the number of vents in the attic?

**Answer:**

Yes, if complying prescriptively. Section 150.1(c)12 requires whole-house fans (WHF) in single-family houses that are in Climate Zones 8-14. These are climate zones that have summer cooling needs but where the home can be efficiently cooled on cool summer evenings by the use of a whole-house fan.

Section 150.1(c)12 also requires that these fans be sized so they provide at least 1.5 cubic feet per minute (CFM) of flow for each square foot of conditioned space in the house. The fans used must be listed in the [Energy Commission's Appliance Database](http://appliances.energy.ca.gov/QuickSearch.aspx) at <http://appliances.energy.ca.gov/QuickSearch.aspx> and the rated CFM listed on the CF2R-MCH-02 form. In addition, the attic must have at least 1 sf of attic vent free area for each 750 CFM of whole-house fan-rated flow.

Thus, for this house with 2,500 sf of conditioned floor area, the minimum total flow rate of whole-house fans installed in the house must be at least:

Min WHF flow rate = Conditioned Floor Area x 1.5 CFM/sf = 2,500 sf x 1.5 CFM/sf = 3,750 CFM.

In this case, the builder has selected two 2,000 CFM whole-house fans. The minimum amount of vent net-free area in the attic is calculated as follows:

Net Free Area = Total WHF CFM / (750 CFM/sf NFA) = (2,000 + 2,000) / 750 = 5.3 sf

---

## 4.8 Refrigerant Charge

### 4.8.1 Refrigerant Charge Verification

This section summarizes the procedures for verifying refrigerant charge for air-conditioning systems as described in RA3.2.

#### 4.8.1.1 Overview

A split-system air conditioner undergoes the final assembly at installation. The installation must be verified to ensure proper performance. Important factors that affect performance include the amount of refrigerant in the system (the charge) and the proper functioning of the metering device. Air conditioner energy efficiency suffers if the refrigerant charge is either too low or too high and if the metering device (TXV or EXV) is not functioning properly. In addition to a loss of efficiency and capacity, errors in these areas can lead to premature compressor failure.

To help avoid these problems, the prescriptive standards require that systems be correctly installed. The prescriptive standards also require that they be field-verified in Climate Zones 2 and 8 through 15. Refrigerant charge verification is also required in any climate zone when chosen as a compliance feature using the performance approach.

The requirement to verify the refrigerant charge after installation does not apply to new packaged systems, where the installer certifies the package system came factory-charged and did not alter the system in any way that would affect the refrigerant level; however, airflow and other requirements must still be verified. The prescriptive standards regarding verification of refrigerant charge do apply to altered package systems in Climate Zones 2 and 8 through 15.

Verification of proper refrigerant charge must occur after the HVAC contractor has installed and charged the system in accordance with the manufacturer's specifications. The procedure requires properly calibrated digital refrigerant gauges, thermocouples, and digital thermometers. When multiple systems in the same home require testing, test each system.

In a typical home cooling system, there are two important performance criteria that are relatively easy to verify that there is neither too much nor too little refrigerant in the system. In systems with a fixed-orifice device in the evaporator coil, the number to check is called the *superheat*. In a system with a variable-metering device, the number to check is called the *subcooling*.

*Superheat* refers to the number of degrees the refrigerant is raised after it evaporates into a gas. This occurs inside the evaporator coil (or *indoor coil*). The correct superheat for a system will vary depending on certain operating conditions. The target superheat for a system must be obtained from a table provided in the RA3.2 protocols or the manufacturer's superheat table. There is an allowed range of

several degrees between the measured superheat and the target superheat for a system to pass.

Subcooling refers to the number of degrees the refrigerant is lowered after it condenses into a liquid. This occurs inside the condenser coil (or *outdoor coil*). The manufacturer specifies the correct subcooling for a system. It may vary depending on operating conditions. Like superheat, there is an allowed range of several degrees between the measured subcooling and the target subcooling for a system to pass.

The temperature at which a refrigerant condenses or evaporates is called the *saturation temperature*. Above the saturation temperature, a refrigerant is always a gas. Below the saturation temperature, a refrigerant is always a liquid.

Saturation is when a refrigerant exists as both a liquid and a gas. It always occurs at the same temperature, depending on what the pressure of the refrigerant happens to be. At higher pressures, the saturation temperature goes up and vice versa. This convenient property is what makes refrigeration work.

The saturation temperature can be determined by simply measuring the pressure of a refrigerant and referring to a table, known as a *pressure-temperature (PT) table*, for that specific refrigerant. Saturation temperatures are well-documented for all common refrigerants.

Because variable refrigerant metering devices are prone to failure and even more so to improper installation, it is important that the operation of these devices be checked. A metering device maintains a relatively constant superheat over a wide range of operating conditions; therefore, checking the superheat, in addition to the other tests performed, will indicate if the metering device is operating correctly.

Unfortunately, checking superheat and subcooling can be done only under certain indoor and outdoor conditions. This verification procedure, called the Standard Charge Verification Method, is very weather-dependent.

There is another way to verify proper refrigerant charge that is not weather-dependent, and that is by weighing the refrigerant. Called the Weigh-in Charge Verification Method, this approach can be performed only by the installer. It can be verified by the HERS Rater either by simultaneous observation or by using the standard method when conditions permit.

#### 4.8.1.2 **Minimum System Airflow Verification for Refrigerant Charge Verification**

To have a valid charge test, the system airflow must be verified to be at least 300 CFM/ton for altered systems and 350 CFM/ton for new systems. The procedures for measuring total system airflow are found in RA3.3. They include plenum pressure matching using a fan flow meter, a flow grid, a powered flow hood, and the

traditional (nonpowered) flow hood. The airflow verification procedures for refrigerant charge verification no longer include the temperature split method.

If an altered system does not meet the minimum airflow requirements, remedial steps are required to increase system airflow. More airflow is generally better for systems with air conditioning. Not only does this allow proper refrigerant charge to be verified, but it improves the overall performance of the system. When able to be performed on a system, regardless of the refrigerant charge verification procedure, minimum system airflow must always be verified.

In some alterations, improving airflow may be cost-prohibitive, and there is a process for documenting this (RA3.3.3.1.5). When this option is used, verification by sample groups is not allowed. Minimum airflow is critical to proper air-conditioner operation. Reducing airflow reduces cooling capacity and efficiency. Many systems in California have oversized equipment and undersized ducts. In newly installed duct systems, the minimum airflow requirement is higher because the opportunity exists to design and install a better system. In altered systems, the installer may be required to modify the ducts system to meet the minimum airflow. The minimums of 300 and 350 CFM/ton are lower than the desired airflow for most systems, which is usually 400 CFM/ton and higher.

**4.8.1.3 Standard Charge Verification Procedure (RA3.2.2)**

The first step is to turn on the air-conditioning system and let it run for at least 15 minutes to stabilize temperatures and pressures. While the system is stabilizing, the HERS Rater or the installer may attach the instruments needed to take the measurements.

**Figure 4-45: Measurements for Refrigerant Charge and Airflow Tests**

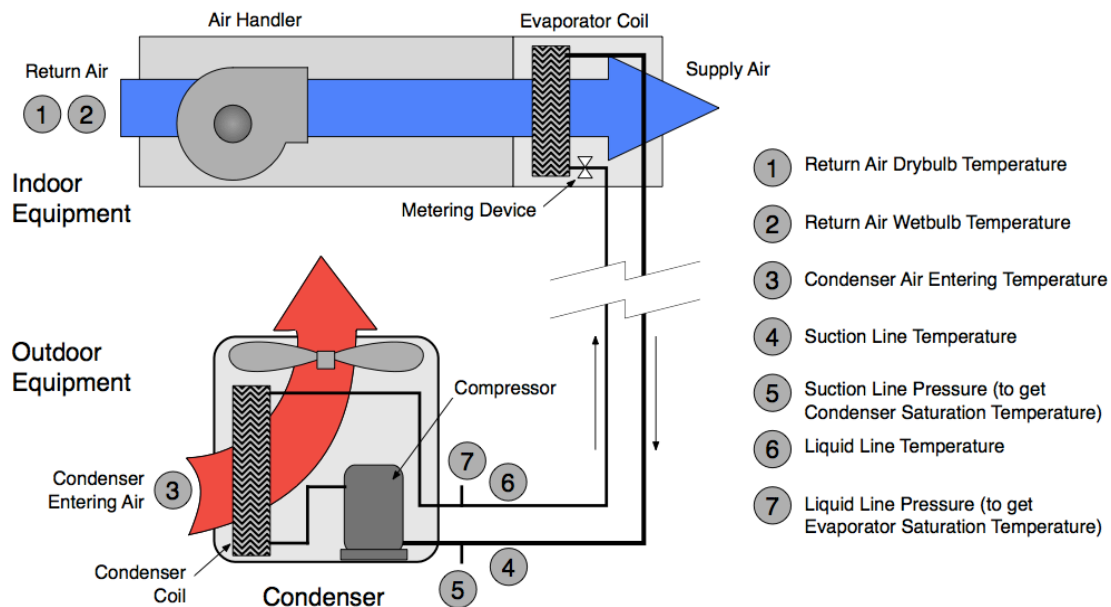

Source: California Energy Commission

The following measurements shall be taken by the technician or HERS Rater, when applicable.

1. The return air wet bulb and dry bulb temperatures are measured in the return plenum before the blower at the location labeled "Title 24 – Return Plenum Measurement Access Hole." This hole must be provided by the installer, not the rater (See Points 1 and 2 in Figure 4-45). See Figure RA 3.2-1 for more information on the placement of the measurement access hole (MAH).
2. Moreover, the outdoor air dry bulb temperature is measured at the point where the air enters the outdoor condensing coil. (See Point 3 in Figure 4-45). It is important that this outdoor temperature sensor be shaded from direct sun during the verification procedure.

In addition to the air temperature measurements, four refrigerant properties need to be measured. Two of these measurements are taken near the suction line service valve before the line enters the outdoor unit and are used to check the superheat.

1. The first measurement is the temperature of the refrigerant in the suction line, which is taken by a clamp-on thermocouple or other suitable device insulated from the outdoor air. (See Point 4 in Figure 4-45.)
2. The second measurement determines the saturation temperature of the refrigerant in the evaporator coil. (See Point 5 in Figure 4-45.) The saturation temperature can be determined from the low-side (suction line) pressure and a saturation temperature table for the applicable refrigerant.

To check the subcooling, two more refrigerant properties are required and may be measured near the liquid line service valve at the point where the line exits the outdoor unit.:

1. The liquid refrigerant temperature in the liquid line is measured by a clamp-on thermocouple insulated from the outdoor air. (See Point 6 in Figure 4-45.)
2. The condenser saturation temperature can be determined from the liquid line pressure and a saturation temperature table for the applicable refrigerant. (See Point 7 in Figure 4-45.)

Determination of the condenser saturation temperature and the liquid line temperature is used only for the subcooling verification method on systems with TXV or EXV metering devices.

#### 4.8.1.4 Superheat Charge Verification Method (RA3.2.2.6.1)

The *Superheat Charge Verification Method* is used on units with a fixed-orifice refrigerant metering device (not a TXV or EXV).

Airflow verification must be confirmed before starting the Superheat Verification Method.

The *Superheat Verification Method* compares the actual (measured) superheat temperature to a target value from a table. The actual superheat temperature is the measured suction line temperature ( $T_{\text{Suction, db}}$ ) minus the evaporator saturation temperature ( $T_{\text{Evaporator, Saturation}}$ ). The target superheat value is read from a table (Table RA3.2-2 or the manufacturer's superheat table).

Only an EPA-certified technician may add or remove refrigerant. Under no circumstances may HERS Raters add or remove refrigerant on systems that they are verifying.

#### 4.8.1.5 Subcooling Verification Method (RA3.2.2.6.2)

The *Subcooling Verification Method* is used on units with a variable refrigerant metering device (a TXV or EXV).

Airflow verification must be confirmed before starting the Subcooling Verification Method.

The Subcooling Verification Method compares the actual subcooling temperature to the target value supplied by the manufacturer. The actual subcooling is the condenser saturation temperature ( $T_{\text{Condenser, Saturation}}$ ) minus the liquid line temperature ( $T_{\text{Liquid}}$ ).

#### 4.8.1.6 Weigh-In Charging Procedure (RA3.2.3)

The weigh-in charging procedure charges the system by determining the appropriate weight of refrigerant based on the size of the equipment and refrigerant lines rather than by measuring steady-state performance of the system. Systems using the weigh-in procedure to meet the refrigerant charge verification requirement may not use group sampling procedures for HERS verification compliance.

The weigh-in procedure does not relieve the installer of the responsibility to comply with the required minimum system airflow.

There are two installer options for completing the weigh-in procedure. One involves adjusting the amount of refrigerant supplied by the manufacturer in a new system, as specified by the manufacturer (weigh-in charge adjustment). The other involves evacuating the entire system and recharging it with the correct total amount of refrigerant, by weight (weigh-in total charge).

The weigh-in charge adjustment procedure may be used only when a new factory-charged outdoor unit is being installed and the manufacturer provides adjustment specifications based on evaporator coil size and refrigerant line size and length.

The weigh-in total charge may be used for any weigh-in procedure but still requires manufacturer's adjustment specifications. Only the installer/technician may perform any kind of weigh-in procedure.

#### 4.8.1.7 **Equipment Limitations**

The Energy Code specifically requires verification of refrigerant charge only for air-cooled air conditioners and air-source heat pumps. All other types of systems are not expressly exempt from the refrigerant charge requirements. Certain portions of the requirements may still apply, such as the minimum system airflow requirement. The installer would have to confirm with the manufacturer and the CEC. The installer must adhere strictly to the manufacturer's specifications.

Variable refrigerant flow systems and systems such as some mini-split systems that cannot be verified using the standard charge verification procedure in RA3.2.2 must demonstrate compliance using the weigh-in method. Verification by the HERS Rater can be accomplished only by simultaneous observation of the installer's weigh-in as specified by RA3.2.3.2, and only if use of HERS Rater observation procedure is specified by the Energy Code.

#### 4.8.1.8 **HERS Verification Procedures**

When required by the CF1R, HERS Raters must perform field verification and diagnostic testing of the refrigerant charge, including verification of minimum system airflow and verification of installation of the measurement access hole.

The verification procedures are essentially identical for the rater and the installer except that the tolerances for passing the superheat and subcooling tests are less stringent for the rater's test. This is to allow for some variations in measurements due to instrumentation or test conditions (for example, weather).

The following conditions prohibit verification using sample groups:

1. When the weigh-in method is used
2. When the minimum airflow cannot be met despite reasonable remediation attempts. (See RA3.3.3.1.5).

As always, to be eligible for sampling, the installer must first verify and pass the system. If sampling is not being used, the rater will perform the verification only after the installer has charged the system according to manufacturer's specifications.

#### 4.8.1.9 **Winter Setup Procedures**

Reference Appendix RA1 provides for the approval of special case refrigerant charge verification procedures. These protocols may be used only if the manufacturer has approved use of the procedure for their equipment.

One such procedure is found in RA1.2 Winter Setup for the standard charge verification procedure (winter charge setup). It provides for a modification to the



standard charge procedure when temperature conditions do not allow use of the RA3.2.2 standard charge verification procedure.

The winter charge setup allows both installers and HERS Raters to verify the charge when outdoor temperatures are below the manufacturer's allowed temperature, or the outdoor temperature is less than 55°F. The Weigh-in Charging Procedure specified in Section RA3.2.3 may also be used when the outdoor temperatures are below the manufacturer's allowed temperature or below 55°F but may be used only by the installer.

The winter charge setup procedure allows the system to operate in the same range of pressure differences between the low-side pressure and the high-side pressure as occurs during warm outdoor temperatures, by restricting the airflow at the condenser fan outlet. The winter charge setup is used only for units equipped with variable metering devices, which include thermostatic expansion valves (TXV) and electronic expansion valves (EXV) for which the manufacturer specifies subcooling as the means for determining the proper charge for the unit, including units equipped with microchannel heat exchangers. Once this pressure differential is achieved, the variable metering device calculations are conducted in the same way as the variable metering device procedures described in RA3.2.2.6.2. All other applicable requirements of Section RA3.2.2 remain the same and must be completed when using the winter charge setup.

Though not specifically mentioned in the FID protocols in Residential Appendix RA3.4.2, the RA 1.2 winter setup method may be used if applicable. Thus for FID verification, the winter setup method may be used in place of the subcooling method.

#### 4.8.1.10 **Using Weigh-In Charging Procedure at Low Outdoor Temperatures**

When a new HVAC system is installed, the HVAC installer must check the refrigerant charge, and a HERS Rater must verify the correct charge; however, an exception to §150.1(c)7A provides for an alternative third-party HERS verification if the weigh-in method is used when the outdoor temperature is less than 55 degrees F.

Typically, when the weigh-in method is used by the installing contractor, a HERS Rater must perform a charge verification in accordance with the RA3.2. standard charge procedure. However, because the RA3.2.2 procedures cannot be used when the outdoor temperatures are less than 55 degrees, the Energy Code provides the installer with two choices:

1. Use the RA3.2.3.1 Installer Weigh-In Charging Procedure to demonstrate compliance and install an occupant-controlled smart thermostat (OCST).
2. Wait for warmer temperatures then perform the standard charge verification procedure. In this case, the installer must agree to return to correct refrigerant charge if a HERS Rater determines later, when the outside temperature is 55 degrees F or above, that correction is necessary as

described in Residential Appendix RA 2.4.4. The installer must also provide written notice to the homeowner and enforcement agency that the charge has not yet been verified. An example homeowner's notification is shown in Figure 4-46.

### Figure 4-46: Example of Notification to Homeowners of Delayed Charged Verification

**Note to Homeowner: We're not done yet!**

Congratulations on your new Air-Conditioning System! Your new system is more efficient than older systems and it has been installed to industry guidelines, ensuring many years of comfort and efficient service.

One thing you to know, however, is that the installation process is not complete! Because your unit was installed when the outside air temperature too low to fine tune the air conditioner, the unit must be serviced and verified when the weather is warmer.

This requires your cooperation. You need to allow access to the unit for your Installer and/or HERS Rater (verifier) to verify that and the airflow are set correctly. Your project is not considered finished until this verification takes place. If it is not done, **your unit may cost more to operate, may not heat and cool as effectively and may not last as long.**

Source: California Energy Commission

---

## 4.9 Compliance and Enforcement

This section describes compliance documentation and field verification requirements related to heating and cooling systems.

### 4.9.1 Design-Phase Documentation

The initial compliance documentation consists of the certificate of compliance (CF1R). It lists the features that the house needs for compliance with the prescriptive or performance requirements.

For the prescriptive compliance approach, the required features are based on the Prescriptive Component Package, shown in Tables 150.1-A and 150.1-B.

For the performance compliance approach, the required features are based on a set of features that the designer has documented to result in a level of efficiency at least as good as the prescriptive component package for single-family houses and townhouses. The calculations for documenting this are done using the [approved performance compliance software](https://www.energy.ca.gov/programs-and-) at <https://www.energy.ca.gov/programs-and->

topics/programs/building-energy-efficiency-standards/2019-building-energy-efficiency-2. The calculation approach is described in the *Residential ACM Reference Manual*.

The performance compliance approach provides maximum design flexibility. It also allows compliance credit for special additional features to be quantified.

The CF1R lists special modeling features for which special compliance credit was taken using the performance approach. They require additional visual verification by the enforcement agency to ensure proper installation. Some require field verification and diagnostic testing by a HERS Rater. These will be listed separately on the CF1R under the following headings. For the purposes of this manual, only HVAC-related features are listed below.

Special Features Not Requiring HERS Rater verification:

1. Ducts in a basement
2. Ducts in a crawlspace
3. Ducts in an attic with a radiant barrier
4. Hydronic heating and system design details
5. Gas-fired absorption cooling
6. Zonal control
7. Ductless wall heaters

Special features requiring HERS Rater verification:

1. Duct sealing
2. Verified duct design – for reduced duct surface area and ducts in conditioned space
3. Low-leakage ducts in conditioned space
4. Low-leakage air handlers
5. Verification of return duct design
6. Verification of air filter device design
7. Verification of bypass duct prohibition
8. Refrigerant charge verification
9. Installation of a fault indicator display (FID)
10. Verified system airflow
11. Air handler fan watt draw
12. High energy efficiency ratio (EER)

13. Verified seasonal energy efficiency ratio (SEER)
14. Heating seasonal performance factor (HSPF)
15. Heat pump - rated heating capacity
16. Continuous whole-dwelling unit mechanical ventilation airflow for IAQ
17. Intermittent dwelling unit mechanical ventilation airflow for IAQ
18. Kitchen exhaust fan verification for IAQ (Local Mechanical Exhaust)
19. Whole-house fan (WHF) airflow and fan efficacy
20. Central fan ventilation cooling system (CFVCS)
21. Variable capacity heat pump (VCHP)
22. HRV/ERV fan efficacy

Information summarizing measures requiring field verification and diagnostic testing is presented in Table RA2-1. The field verification and diagnostic testing protocols that must be followed to qualify for compliance credit are described in RA3

Registration of the CF1R with an approved HERS Provider is required. The building owner or the person responsible for the design must submit the CF1R to a HERS Data Registry for retention according to the procedures described in Section 10-103 and RA2. Registration ensures that the project follows the appropriate verification process, provides tracking, and provides electronic access to authentic documentation.

#### **4.9.2 Construction-Phase Documentation**

During construction, the general contractor or specialty subcontractors must complete all applicable CF2Rs for the building design special features specified on the CF1R.

Registration of the CF2R is required. The licensed contractor responsible for the installation must submit the CF2R information that applies to the installation to a HERS Provider Data registry using procedures described in Section 10-103 and RA2. CF2R documents corresponding to the list of special features requiring HERS Rater verification in Section 4.9.1 are required.

#### **4.9.3 Field Verification and Diagnostic Testing**

When the CF1R and CF2Rs require HERS field verification, a HERS Rater must visit the site to perform the tests necessary to complete the applicable heating and cooling system certificates of verification (CF3R). A CF3R is available for each special feature requiring HERS Rater verification given in Section 4.9.1.

Field verification for nonmandatory features is necessary only when performance credit is taken for the measure. Some field verifications are mandatory in all homes unless they are exempted in the Energy Code by specific exceptions.

Registration of the CF3R is required. The HERS Rater must submit the field verification and diagnostic testing information to the HERS Data Registry as described in Chapter 2. For additional details describing HERS verification and the registration procedure, refer to RA2.

## TABLE OF CONTENTS

5	Water Heating Requirements.....	1
5.1	Overview .....	1
5.1.1	What’s New for 2022 .....	1
5.1.2	At a Glance.....	1
5.1.3	Water Heating Energy .....	2
5.2	Residential Water Heating Equipment .....	3
5.2.1	Instantaneous Water Heaters.....	3
5.2.2	Storage Water Heater .....	4
5.2.3	Water Heater Maintenance.....	7
5.2.4	Drain Water Heat Recovery Devices.....	9
5.3	Mandatory Requirements for Water Heating .....	10
5.3.1	Equipment Certification.....	10
5.3.2	Equipment Efficiency .....	10
5.3.3	Storage Tank Insulation.....	13
5.3.4	Isolation Valves.....	13
5.3.5	High-Efficiency Electric Ready for Gas Water Heater.....	14
5.3.6	Mandatory Requirements for Hot Water Distribution Systems.....	15
5.4	Prescriptive Requirements for Water Heating .....	18
5.4.1	Single Dwelling Units .....	18
5.5	Performance Approach Compliance for Water Heating .....	23
5.5.1	Energy Budget Calculation .....	23
5.5.2	Systems Serving a Single Dwelling Unit .....	23
5.5.3	Treatment of Water Heater Efficiency .....	25
5.5.4	Compliance Issues.....	25
5.6	Distribution Systems.....	25
5.6.1	Types of Water Heating Distribution Systems .....	25
5.6.2	Systems Serving a Single Dwelling Unit .....	25
5.7	Combined Hydronic System.....	34

---

- 5.7.1 Combined Hydronic..... 34
- 5.8 Showerheads..... 34
  - 5.8.1 Certification of Showerheads and Faucets ..... 34
- 5.9 Solar Water Heating ..... 34
  - 5.9.1 Solar or Recovered Energy in State Buildings..... 35
- 5.10 Swimming Pool and Spa Heating ..... 36
  - 5.10.1 Swimming Pool and Spa Types..... 36
  - 5.10.2 Mandatory Requirements for Pools and Spas..... 36
- 5.11 Compliance and Enforcement..... 41
  - 5.11.1 Design Review ..... 41
  - 5.11.2 Field Inspection ..... 42
  - 5.11.3 HERS Field Verification and/or Diagnostic Testing ..... 42
- 5.12 Glossary/Reference ..... 42
  - 5.12.1 General Glossary/Reference for Water Heating ..... 42
  - 5.12.2 General Glossary/Reference for Swimming Pool and Spa ..... 43

## 5 Water Heating Requirements

---

### 5.1 Overview

Chapter 5 describes the compliance requirements for domestic water heating for newly constructed residential dwellings, including single-family, duplex, triplex, and townhouses. This chapter also describes common water heater types, best practices for water heater maintenance, hot water distribution system designs, and examples of commonly asked questions regarding compliance with Energy Codes requirements. For general information about compliance and enforcement please see Chapter 2 of this compliance manual. For information about water heating requirements for additions and alterations, please see Chapter 9.

#### 5.1.1 What's New for 2022

This section summarizes changes to the requirements for residential water heating for the 2022 Energy Codes. Please see Sections 5.3 and 5.4 for detailed information on the mandatory and prescriptive water heating requirements in the 2022 Energy Codes.

##### 5.1.1.1 Mandatory Requirements

1. Simplify the hot water piping language and align with the Plumbing Code.
2. Updated HPWH ready requirements for gas water heater installations that includes providing a designated space for a future HPWH installation (see Electric Readiness – Chapter 10).

##### 5.1.1.2 Prescriptive Requirements

Water heating equipment is required to be a heat pump water heater or a solar water heating system with electric backup and minimum 70% solar fraction. In Climate Zones 3, 4, 13, and 14 a gas instantaneous water heater is allowed. (§150.1(c)8)

##### 5.1.1.3 Performance Compliance Method

When the performance compliance method is used, the energy budget is based on the performance of a heat pump water heater in all climate zones except 3, 4, 13, and 14, where the energy budget is based on a gas instantaneous water heater. For more information, see section 5.5.

#### 5.1.2 At a Glance

Table 5-1 provides an overview of the location of the water heating requirements in the *2022 Energy Codes* by construction and building type.



**Table 5-1: Overview of Water Heating Requirements in the Energy Codes and This Chapter**

Type	Mandatory Requirements	Mandatory Requirements	Prescriptive Requirements	Prescriptive Requirements	Performance Requirements	Performance Requirements
	Standards Section	Manual Section	Standards Section	Manual Section	Standards Section	Manual Section
Single-family dwelling	§110.3; §150.0(j) §150.0(n)	5.3	§150.1(c)8A  i, ii, iii, iv, v	5.4.1	§150.1(b)	5.5
Addition	§110.3; §150.0(j) §150.0(n)	5.3, 9	§150.2(a)1D	5.4.1	§150.2(a)2	5.5
Alteration	§110.3; §150.0(j) §150.0(n)	5.3, 9	§150.2(b)1H	5.4.1	§150.2(b)2	5.5

Source: California Energy Commission

### 5.1.3 Water Heating Energy

Total energy use associated with water heating consists of the end use, heater inefficiencies, standby loss, and distribution system inefficiencies. Figure 5-1 below shows the energy flows that constitute water heating energy usage. Hot water draws at the end use points (for example, faucets, showers, and so forth) represent the useful energy consumed. In most cases, hot water that is actually used represents the largest fraction of water heating energy use, although in situations when there are very few hot water draws, standby losses from a standard gas storage water heater and the hot water distribution system can exceed the quantity of useful energy consumed at the end point. Energy impacts associated with the hot water distribution system vary widely based on the type of system, quality of insulation and installation, building and plumbing design, and hot water use patterns. Distribution losses in a typical single-family home may be as much as 30 percent of the total energy used for water heating. Distribution losses in single-family homes with compact hot water distribution systems may be lower than 10 percent of total water heating energy use. In a typical multifamily building, distribution losses can account for more than 30 percent of total water heating energy use. An important consideration for any water heating system is the recovery load (that is, end use plus distribution losses) of the water heating unit minus any contribution from auxiliary heat inputs, such as a solar thermal system.

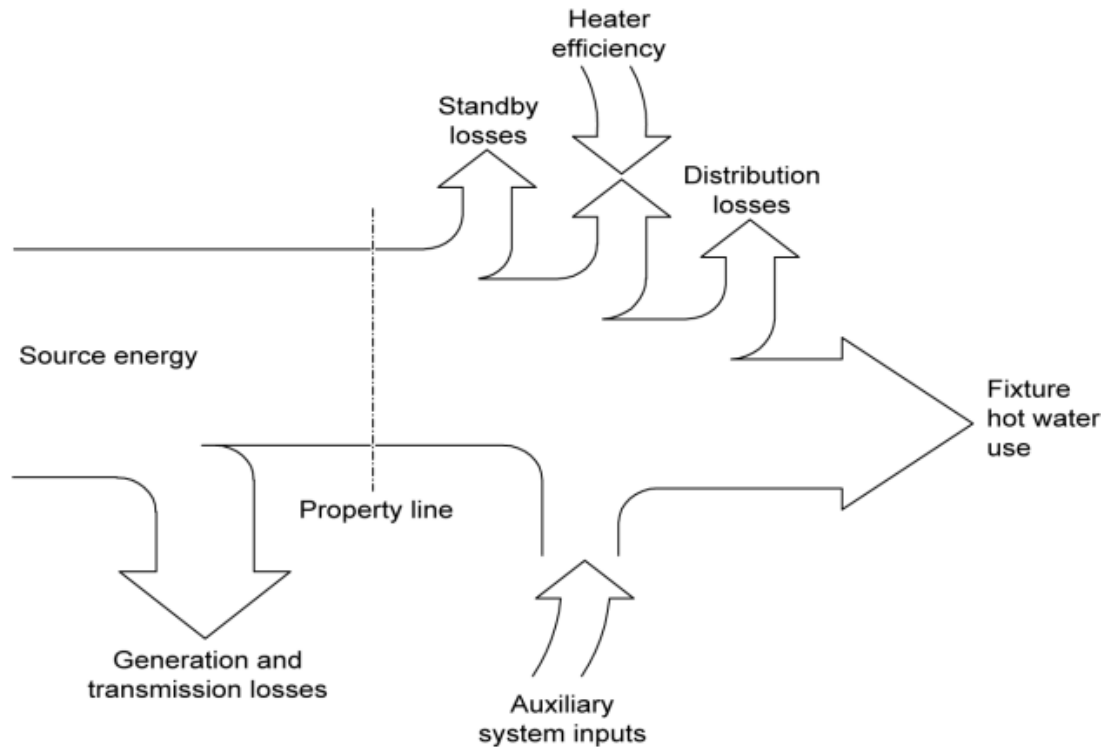
**Figure 5-1: Water Heating Energy Flow Representation**

## 5.2 Residential Water Heating Equipment

There are several types of residential water heaters described below. The most common water heaters in single-family homes are consumer storage or instantaneous water heaters.

To comply with the Energy Codes using either the prescriptive or performance approach, the water heater must meet the federal and/or the California Appliance Efficiency Regulations (Title 20).

### 5.2.1 Instantaneous Water Heaters

Instantaneous water heaters, commonly referred to as *tankless* or *on-demand*, heat water using natural gas, electricity, or propane. These units do not have a tank for storing heated water but instead use a sensor that detects the flow of water over the heat exchanger that initiates the heating element (typical volumes around 0.5 gallons). Instantaneous units are capable of delivering water at a controlled temperature of less than 180°F. The input rating for gas instantaneous water heaters ranges between 50,000 and 200,000 BTU per hour (at least 4,000 BTU per hour per gallon of stored water) with a storage capacity of less than 2 gallons.

Instantaneous water heaters require an electrical connection for controls and the combustion air blower, a direct or power venting system, and a larger gas line (typical input ratings of 140,000 to 200,000 BTU/hr).

Electric instantaneous water heaters are not generally designed for use with solar water heating systems or as heat sources for indirect-fired water heaters. They are also typically inappropriate for use with recirculation systems. Consult manufacturer's literature when considering these applications. Electric instantaneous water heaters are not allowed through the prescriptive approach to compliance but can be installed using the performance approach as long as the total energy budget is not exceeded.

## 5.2.2 Storage Water Heater

### 5.2.2.1 Consumer Storage Water Heaters

Storage water heaters use gas (natural gas or propane), electricity or oil to heat and store water at a thermostatically controlled temperature (less than 180° F) for delivery on demand. Federal appliance efficiency standards differentiate storage water heaters based on whether the rated storage volume is greater than 55 gallons or less than or equal to 55 gallons.

The U.S. Department of Energy (DOE) classifies consumer gas water heaters as having an input of 75,000 BTU per hour or less and has a storage capacity ranging between 20 and 100 gallons. A basic gas storage water heater is composed of a standing pilot ignition system, a burner, a combustion chamber, a flue baffle, a flue, an insulated water tank, a cold water inlet and hot water outlet, a sacrificial anode, a gas valve, a temperature and pressure relief valve, a thermostat, heat traps, and an outer case.

The DOE classifies consumer electric storage water heaters as having an input of 12 kilowatt (kW) or less and have a storage capacity ranging between 20 and 120 gallons. A basic electric storage consumer water heater differs from gas water heaters by using an electric resistance heating element. As noted in this chapter, electric storage water heaters are not allowed through the prescriptive approach to compliance but can be installed using the performance approach as long as the water heating energy budget is not exceeded.

DOE added a new category of water heaters called *grid-enabled water heaters* and is defined as an electric resistance water heater that has a rated storage tank volume of more than 75 gallons and is manufactured on or after April 16, 2015. The water heater must have an activation lock at the point of manufacture and is intended for use only as part of an electric thermal storage or demand response program.

### 5.2.2.2 Heat Pump Water Heater (HPWH)

A heat pump water heater (HPWH) is an electric water heater that works like a air conditioner in reverse. It uses a compressor to transfer heat from the surrounding air to the water tank. It includes all necessary auxiliary equipment such as fans, storage tanks, pumps, or controls. Typically, HPWHs include backup electric resistance elements to ensure hot water delivery when the air temperature is too cold or the hot water demand is too high. Some models entering the market use larger compressors to avoid the need for resistance elements.

The performance of HPWHs depends both on storage water temperature and inlet air temperature. Buildings in warm and cold climate zones, and different installation locations such as a garage or well vented outdoor closet, all have an impact on performance and must be considered. If the HPWH is installed in a confined water heater closet, carefully follow manufacturer instructions on the use of ducting to discharge exhaust air out of the closet. Without ducting, a confined closet can result in overcooling of the air, significantly diminishing HPWH performance.

HPWHs are most efficient in warmer climates, but even in cold climate zones such as Climate Zone 16, HPWHs still use only half as much electricity as conventional electric resistance water heaters. In addition to air temperature sensitivity, HPWH performance is affected by cold water inlet temperatures as introduction and mixing of inlet water during larger draws may trigger second stage electric resistance heating in the tank.

The Northwest Energy Efficiency Alliance (NEEA) Advanced Water Heater Specification was developed to address critical performance and comfort issues of HPWH in colder climates. Tiers are incorporated into this specification recognizing variations in product performance and configuration. An HPWH that meets the NEEA Advanced Water Heater Specification performs significantly better in real world conditions, and an HPWH that meets the NEEA Tier 3 or higher can be used to meet the prescriptive requirement for newly constructed buildings, addition, and alteration.

The [list of qualified NEEA HPWH](https://neea.org/img/documents/qualified-products-list.pdf) products can be found at <https://neea.org/img/documents/qualified-products-list.pdf>

In 2020, the Energy Commission adopted Joint Appendix (JA) 13, which provides qualification requirements for HPWH demand management systems. Qualifying HPWHs have the capability to optimize operation to reduce normal water heater operation during on-peak periods by biasing operation prior to the peak period. Future opportunities include heating the storage tank above setpoint prior to the peak period, further improving the electrical load profile of these systems. A credit exists for these HPWHs within the compliance software. [JA13 certified HPWHs](#), which must have a mixing valve installed to prevent any scalding risks, are currently listed at this website:

<https://www.energy.ca.gov/rules-and-regulations/building-energy-efficiency/manufacture-certification-building-equipment/ja13>

---

**Example 5-1 – HPWH:****Question:**

Are there any additional compliance credits available for unitary HPWHs?

**Answer:**

NEEA Tier 3 and Tier 4 rated HPWHs are available in the performance compliance software and provide compliance credit compared to the standard design HPWH. Additionally, with the approval of JA13, there is now credit within the performance compliance software for HPWHs that are JA13-certified and provide the Basic Load Up demand management functionality. This credit varies with climate zone. Note that a mixing valve must be installed to ensure safe hot water delivery.

**5.2.2.3 Air-to-Water Heat Pumps with Water Heating Capability**

Air-to-water heat pumps provide space heating and cooling output via hydronic delivery. Some models also provide a water heating function. These products are emerging in the California market, but the residential compliance software can model the water heating capability of these units.

**5.2.2.4 Residential-Duty Commercial Water Heater**

This appliance is essentially a commercial water heater that can be legally installed in a residential building. It is defined in the Federal Code of Regulations (10 CFR 431.102) as any gas-fired, electric, or oil storage or instantaneous commercial water heater that meets the following conditions:

1. Uses a single-phase external power supply for models that require electricity.
2. Is not designed to provide outlet hot water at temperatures greater than 180°F.
3. Is not excluded by the specified limitations regarding rated input and storage capacity as described in Table 5-2 below. In other words, a residential-duty commercial water heater must have rate input and rated storage volume **below** the value listed in Table 5-2.

**Table 5-2: Capacity Limitations for Defining Commercial Water Heaters Without Residential Applications**

<b>Water Heater Type</b>	<b>Indicator of Nonresidential Application</b>
Gas-Fired Storage	Rated input >105 kBTU/h; Rated storage volume >120 gallons.
Oil-Fired Storage	Rated input >140 kBTU/h; Rated storage volume >120 gallons.
Electric Instantaneous	Rated input >58.6 kW; Rated storage volume >2 gallons.

Source: [U.S. Department of Energy \(2014\)](http://www.regulations.gov/#!documentDetail;D=EERE-2011-BT-TP-0042-0082). "Energy Conservation Program for Consumer Products and Certain Commercial and Industrial Equipment: Test Procedures for Residential and Commercial Water Heaters; Final Rule." <http://www.regulations.gov/#!documentDetail;D=EERE-2011-BT-TP-0042-0082>

Residential-duty commercial water heaters are rated in uniform energy factor (UEF) and can be installed using the performance approach as long as the total energy budget is not exceeded.

**5.2.2.5 Hot Water Supply Boiler**

A *hot water supply boiler* is industrial water heating equipment with a heat input rate from 300 to 12,500 kBtu per hour and at least 4,000 BTU per hour per gallon of stored water. A hot water boiler should have either the temperature or pressure control necessary for heating potable water for purposes other than space heating, or the boiler manufacturer's literature should indicate that the intended uses of the boiler include heating potable water for purposes other than space heating. A hot water boiler could be fueled by oil or gas, and it must adhere to the minimum thermal efficiency and maximum standby loss as described in California's *Title 20 Appliance Efficiency Regulations*.

Boilers are typically used for doing both space heating and water heating. Use of a boiler will typically require one or more unfired storage tanks to be installed as part of the system. Careful attention should be given to the layout of these systems due to the potential for high energy losses between the boiler and storage tanks. Boilers are not allowed through the prescriptive approach to compliance but can be installed using the performance approach as long as the water heating energy budget is not exceeded.

### 5.2.3 Water Heater Maintenance

Water heaters should be maintained according to manufacturer recommendations to ensure proper water heater performance, prolonged useful life, and warranty coverage. If water heaters are not maintained, the useful life of the unit can be shortened and failures that may result may not be covered under the warranty. This section presents the best practices for maintaining the life and efficiency of water heaters.

#### 5.2.3.1 Maintenance of Instantaneous Water Heaters

The primary maintenance activities for instantaneous water heaters are flushing the heat exchanger to remove scale buildup and inspecting and cleaning the inlet water filter screen, which helps minimize the amount of debris or sediment that enters the water heater.

Some manufacturers recommend a maintenance schedule, but the maintenance schedule users deploy may vary based on water quality. In areas with hard water, more frequent maintenance (every two years) is recommended. In areas where the water quality is relatively good, water heater maintenance is recommended every three to four years. Frequent inspection of the inlet water filter screen will enable a user to monitor the amount of sediment entering the water heater. If the filter tends to fill with sediment regularly, then more frequent flushing may be required. Users can also reference local water quality data to determine the level of water quality in their area to help guide maintenance schedules.

To assist in flushing the heat exchanger, manufacturers and plumbers recommend the installation of a drain kit (that is, isolation valves). (See Figure 5-2 below.) The installation of isolation valves on instantaneous units is mandatory in the *Energy Codes* (Section 110.3[c]6 and Section 150.0 [n]4). Isolation valves enable the unit to be

isolated from both the inlet cold water and the outlet hot water lines, thereby allowing the heat exchanger to be flushed using a simple procedure. Integral to the kit are hose bibs that allow the flushing hoses to be attached. Instantaneous water heater that has integrated drain ports for servicing are acceptable to meet the requirements of Section 110.3(c)6 and will not require additional isolation valves.

Manufacturers recommend that a licensed professional flush the heat exchanger to avoid potentially damaging the water heater, though some manufacturers sell flush kits so that homeowners can maintain their own water heater. Flush kits consist of a submersible pump, two short hoses, hose connections, and a 5-gallon bucket. These components can be purchased separately or as a preassembled kit. A solution of white vinegar is widely recommended for flushing the heat exchanger as it is food-grade and very effective at removing scale.

In addition to flushing the heat exchanger, manufacturers recommend periodically inspecting and cleaning the inlet water filter screen, which helps minimize the amount of debris or sediment that enters the water heater. This can be done by running the filter screen under hot water and using a brush to remove debris. Replacement of the inlet water filter screen is not necessary unless it is damaged.

**Figure 5-2: Isolation Valves**



Source: BrassCraft at <http://www.brasscraft.com/products.aspx?id=266>

### 5.2.3.2 Maintenance of Storage Water Heaters

For storage water heaters, the primary maintenance activities consist of draining the tank, inspecting the anode rod, and replacing the anode rod, if necessary. The recommended frequency of regular maintenance varies by manufacturer. Like instantaneous water heaters, the frequency of maintenance depends on water quality. Most manufacturers recommend draining the tank every six months to once per year to remove sediment that has accumulated in the bottom of the tank. Periodic inspections (every six months to once a year) of the burner, venting system, and temperature and pressure relief valves are also recommended by manufacturers.

Manufacturers typically recommend inspecting the anode rod every two years and replacing it when necessary to prolong tank life, but the frequency of inspection depends on local water conditions. If water is soft or a water softener is used, more frequent inspection of the anode is needed as softened water will corrode the sacrificial anode rod at a much faster rate than unsoftened water. If the setup of the water heater prevents an easy removal of the corroded anode rod, then it might be necessary to completely move the tank from the location to replace the anode rod.

HPWHs have a unique maintenance requirement that involves inspection and cleaning of the air filter. Since the system utilizes a fan to move air across the system's refrigerant heat exchanger, the air filter must be checked on a regular basis (3-4 times per year). Many manufacturers provide filter cleaning alerts either through an app or on the HPWH display screen.

### **5.2.4 Drain Water Heat Recovery Devices**

Drain water heat recovery (DWHR) is a technology that captures shower waste heat from the drain line. DWHR devices are counter flow heat exchangers, with cold water entering the building on one side of the device and hot drain water exiting the building on the other.

For the 2022 Title 24 Standards, DWHR is a component of an alternative prescriptive path. It is also a compliance option for other water heating applications. DWHR technologies are most prevalent and perform best in cold climates in applications with large water heating loads and colder inlet water temperatures. California, being a generally milder climate, will show somewhat diminished performance relative to the preferred applications.

A DHWR device uses the reclaimed heat to preheat potable cold water that is then delivered either to the shower or the water heater. The device can be installed in either an "equal flow" configuration (with preheated water being routed to both the water heater and the shower) or an "unequal flow" configuration (preheated water directed to either the water heater or shower). Figure 5-3 schematically shows the three installation configurations. The energy harvested from a DWHR device is maximized in an equal flow configuration. They are sold in both vertical design configurations, as shown in Figure 5-3, and in horizontal configurations. The two forms each have advantages and disadvantages, which should be evaluated for each potential installation.

To use these systems to comply with Energy Codes, the design and installation must be HERS-verified and meet the Reference Appendix RA4.4.21 requirements.



**Figure 5-3: The Three Plumbing Configurations of DWHR Installation (From left to right: Equal Flow, Unequal Flow - Water Heater, Unequal Flow - Fixture)**

Similar graphic:

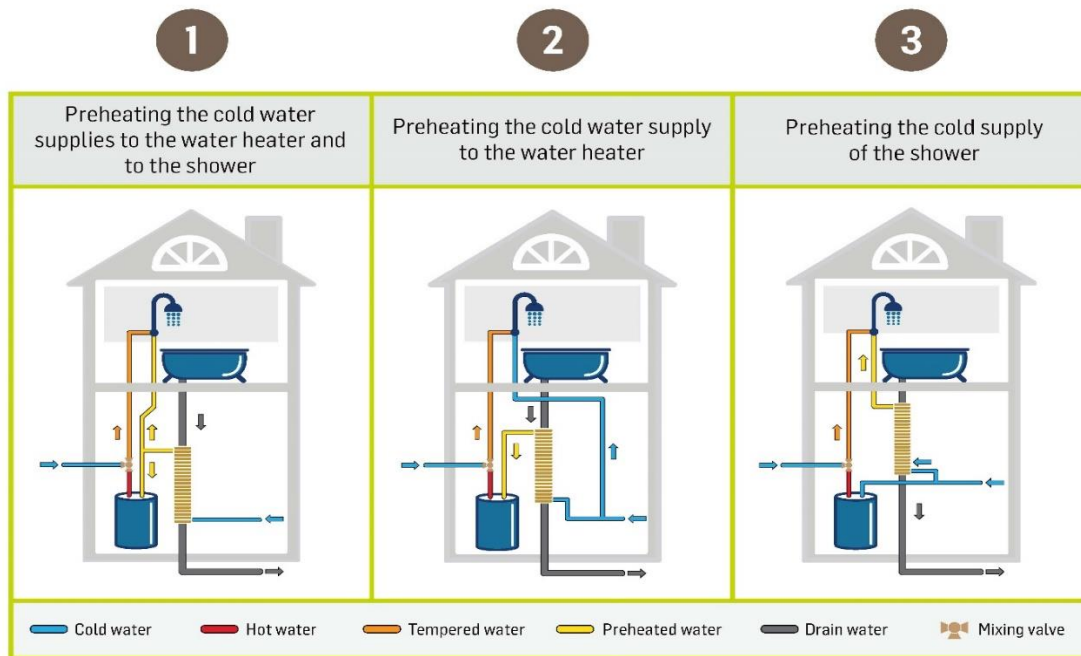

Source: California Energy Commission

## 5.3 Mandatory Requirements for Water Heating

### 5.3.1 Equipment Certification

**§110.3(a)**

Manufacturers must certify that their products comply with California's *Title 20 Appliance Efficiency Regulations*, Section 1605.1(f) at the time of manufacture. Regulated equipment that applies to all of the aforementioned system types in Section 5.2 must be listed in the California Energy Commission Appliance Efficiency Database.

### 5.3.2 Equipment Efficiency

**§110.3(b), §110.1**

Water heaters are regulated under California's *Title 20 Appliance Efficiency Regulations*, Section 1605.1(f). These regulations align with the federal efficiency standards for water heaters. Consumer water heaters and residential-duty commercial water heaters are both rated in Uniform Energy Factor (UEF). The draw pattern is based on the water

heater's design first hour rating for storage water heaters, or gallon per minute for instantaneous water heaters. The efficiency requirements for the most common consumer water heaters are given in Table 5-4 below. The efficiency requirements for the residential-duty commercial water heaters are given in Table 5-5 below.

The Energy Commission has developed a [water heater efficiency guide](https://www.energy.ca.gov/sites/default/files/2020-07/2019_WaterHeating_Guide.pdf) to allow quick lookup of the minimum efficiency of the most common types and sizes of water heaters. It is available to download at [https://www.energy.ca.gov/sites/default/files/2020-07/2019\\_WaterHeating\\_Guide.pdf](https://www.energy.ca.gov/sites/default/files/2020-07/2019_WaterHeating_Guide.pdf).

**Table 5-4: Minimum Federal UEF Requirements for Consumer Water Heaters**

Product class	Rated storage volume	Draw pattern	UEF
Gas-fired Storage Water Heater	≥20 gal and ≤55 gal	Very Small	0.3456 – (0.0020 × Vr)
Gas-fired Storage Water Heater	≥20 gal and ≤55 gal	Low	0.5982 – (0.0019 × Vr)
Gas-fired Storage Water Heater	≥20 gal and ≤55 gal	Medium	0.6483 – (0.0017 × Vr)
Gas-fired Storage Water Heater	≥20 gal and ≤55 gal	High	0.6920 – (0.0013 × Vr)
Gas-fired Storage Water Heater	>55 gal and ≤100 gal	Very Small	0.6470 – (0.0006 × Vr)
Gas-fired Storage Water Heater	>55 gal and ≤100 gal	Low	0.7689 – (0.0005 × Vr)
Gas-fired Storage Water Heater	>55 gal and ≤100 gal	Medium	0.7897 – (0.0004 × Vr)
Gas-fired Storage Water Heater	>55 gal and ≤100 gal	High	0.8072 – (0.0003 × Vr)
Electric Storage Water Heaters	≥20 gal and ≤55 gal	Very Small	0.8808 – (0.0008 × Vr)
Electric Storage Water Heaters	≥20 gal and ≤55 gal	Low	0.9254 – (0.0003 × Vr)
Electric Storage Water Heaters	≥20 gal and ≤55 gal	Medium	0.9307 – (0.0002 × Vr)
Electric Storage Water Heaters	≥20 gal and ≤55 gal	High	0.9349 – (0.0001 × Vr)

Electric Storage Water Heaters	>55 gal and ≤120 gal	Very Small	$1.9236 - (0.0011 \times Vr)$
Electric Storage Water Heaters	>55 gal and ≤120 gal	Low	$2.0440 - (0.0011 \times Vr)$
Electric Storage Water Heaters	>55 gal and ≤120 gal	Medium	$2.1171 - (0.0011 \times Vr)$
Electric Storage Water Heaters	>55 gal and ≤120 gal	High	$2.2418 - (0.0011 \times Vr)$
Instantaneous Gas-fired Water Heater	<2 gal and >50,000 Btu/h	Very Small	0.8
Instantaneous Gas-fired Water Heater	<2 gal and >50,000 Btu/h	Low/Medium/High	0.81
Instantaneous Electric Water Heater	<2 gal	Very Small/Low/Medium	0.91
Instantaneous Electric Water Heater	<2 gal	High	0.92
Grid-Enabled Water Heater	>75 gal	Very Small	$1.0136 - (0.0028 \times Vr)$
Grid-Enabled Water Heater	>75 gal	Low	$0.9984 - (0.0014 \times Vr)$
Grid-Enabled Water Heater	>75 gal	Medium	$0.9853 - (0.0010 \times Vr)$
Grid-Enabled Water Heater	>75 gal	High	$0.9720 - (0.0007 \times Vr)$

Source: U.S. Department of Energy

**Table 5-5: Minimum Federal Uniform Energy Factor Requirements for Residential-Duty Commercial Water Heaters**

Product class	Specifications	Draw pattern	UEF
Gas-Fired Storage	>75 kBTU/hr and ≤105 kBTU/hr and ≤120 gal	Very Small	0.2674 – (0.0009 × Vr)
Gas-Fired Storage	>75 kBTU/hr and ≤105 kBTU/hr and ≤120 gal	Low	0.5362 – (0.0012 × Vr)
Gas-Fired Storage	>75 kBTU/hr and ≤105 kBTU/hr and ≤120 gal	Medium	0.6002 – (0.0011 × Vr)
Gas-Fired Storage	>75 kBTU/hr and ≤105 kBTU/hr and ≤120 gal	High	0.6597 – (0.0009 × Vr)
Oil-Fired Storage	>105 kBTU/hr and ≤140 kBTU/hr and ≤120 gal	Very Small	0.2932 – (0.0015 × Vr)
Oil-Fired Storage	>105 kBTU/hr and ≤140 kBTU/hr and ≤120 gal	Low	0.5596 – (0.0018 × Vr)
Oil-Fired Storage	>105 kBTU/hr and ≤140 kBTU/hr and ≤120 gal	Medium	0.6194 – (0.0016 × Vr)
Oil-Fired Storage	>105 kBTU/hr and ≤140 kBTU/hr and ≤120 gal	High	0.6740 – (0.0013 × Vr)
Electric Instantaneous	>12 kW and ≤58.6 kW and ≤2 gal	All draw pattern	0.80

Source: California Energy Commission, *Title 20 Appliance Efficiency Regulations* (2014)

### 5.3.3 Storage Tank Insulation

§110.3(c)3

Unfired water heater storage tanks and solar water heater backup tanks must have one of the following:

1. External insulation with an installed R-value of at least R-3.5
2. Internal and external insulation with a combined R-value of at least R-16
3. The heat loss of the tank based on an 80-degree F water-air temperature difference shall be less than 6.5 Btu per hour per sq ft. This corresponds to an effective resistance of R-12.3

### 5.3.4 Isolation Valves

§110.3(c)6

All newly installed instantaneous water heaters (minimum input of 6.8 kBTU/hr) shall have isolation valves on both the incoming cold water supply and the hot water pipe leaving the water heater. Isolation valves assist in the flushing of the heat exchanger and help prolong the life of instantaneous water heaters. Instantaneous water heater that has integrated drain ports for servicing are acceptable to meet the requirements of §110.3(c)6 and will not require additional isolation valves.

### **5.3.5 High-Efficiency Electric Ready for Gas Water Heater**

§150.0(n)

To facilitate future installations of HPWH, the Energy Codes contain the following mandatory requirements for s gas or propane water heaters. When a gas or propane water heater is installed, the building must be made electric ready to minimize future retrofit costs when gas appliances are replaced with electric appliances. Dedicated space for a future HPWH, and wiring is required to be run to the designated location. Space must also be reserved at the electric panel to serve a future heat pump water heater, and a condensate drain must be installed

These requirements are for newly constructed buildings and additions (if a water heater is installed in the added floor area), and they are not applicable to alterations. Moreover, these requirements are not applicable when installing an electric water heater.

1. A dedicated 125-volt (V) electrical receptacle that is within 3 feet of the water heater and accessible to the water heater with no obstructions, and be connected to a three conductor, 10 AWG branch circuit. In addition, the unused conductor must be labeled and electrically isolated and have a reserved circuit breaker space.
2. A condensate drain that is no more than 2 inches higher than the base of the installed water heater and allows natural draining without pump assistance

These requirements make it easier for someone to retrofit HPWH in the future. Wiring during initial construction stage is much less costly than trying to retrofit it later.

#### **5.3.5.1 Electrical Receptacle**

The goal of this requirement is to allow easy installation of HPWH when the existing gas water heater needs to be replaced. HPWH typically requires a 240-volt circuit, and this requirement allows an electrician to easily convert the 120-volt circuit to a 240-volt circuit.

The electrical receptacle must be installed with 3 feet from the water heater. It should be connected to a dedicated circuit with a 10 AWG copper branch circuit. The ends of the unused conductor must be labeled as "spare" and be electrically isolated.

A reserved single-pole circuit breaker space must be placed in the electrical panel next to the circuit breaker for the branch circuit and labeled with the words "Future 240V Use."

#### 5.3.5.2 Condensate Drain

The requirement for the condensate drain being placed near the water heater and no higher than the base of the tank allows the condensate to be removed without relying on a sump pump.

### 5.3.6 Mandatory Requirements for Hot Water Distribution Systems

#### 5.3.6.1 Pipe Insulation for All Buildings

§150.0(j)1

All domestic hot water piping shall be insulated as specified in Section 609.11 of the California Plumbing Code, which requires pipe insulation thickness equal to or more than the diameter of the pipe, up to 2 inches. Above pipe diameter of 2 inches, the insulation thickness must be at least 2 inches.

All domestic hot water pipes that are buried below grade must be installed in a waterproof and noncrushable casing or sleeve. The installation shown in Figure 5-4 below would not meet the installation requirements since it is not insulated. In addition, in Figure 5-4 the hot and cold water lines are not separated. Heat transfer will occur, resulting in energy loss and causing condensation on the cold water line.

**Figure 5-4: Noncompliant Below-Grade Piping and Hot and Cold Water Lines Separation**

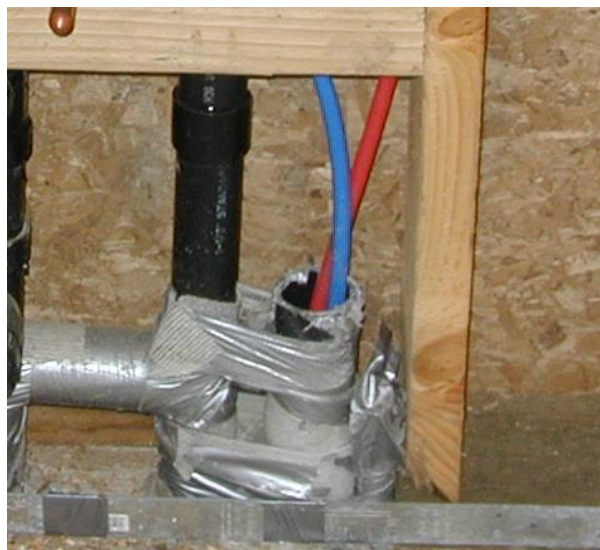

Source: Davis Energy Group/Frontier Energy

#### A. Piping Exempt From the Mandatory Insulation Includes:

1. Factory-installed piping within space conditioning equipment.
2. Piping that serves process loads, gas piping, cold domestic water piping (other than within 5 feet of the water heater), condensate drains, roof drains, vents, or waste piping.
3. Piping that penetrates framing members. This piping is not required to have insulation where it penetrates the framing. However, if the framing is metal, then some insulating material must prevent contact between the pipe and the metal framing.
4. Piping located within exterior walls that are installed so that piping is placed inside wall insulation. Wall insulation may be an acceptable alternative insulation method for sections of pipes that would otherwise need pipe insulation, as long as the wall insulation in the walls where the pipes are located meets the requirements of QII and the pipes are roughly centered in the wall cavity. (see Reference Appendix RA4.4.1).
5. Piping surrounded with at least 1 inch of wall insulation, 2 inches of crawl space insulation, or 4 inches of ceiling insulation. For pipes buried in attic insulation, piping may not be placed directly in contact with sheetrock and then covered with insulation to meet this requirement.

**B. Other installation information:**

1. Insulation must be at least 6 inches away from the flue. If possible, bend the pipe away from the flue. Otherwise, it may be necessary to stop pipe insulation short of the storage tank. (See the current version of the California Mechanical Code.)
2. All pipe insulation seams must be sealed.
3. Installed piping may not be located in supply or return air plenums. (See the current version of the California Mechanical Code.)
4. Hot and cold water piping, when installed in parallel runs, must be at least 2 inches apart. (See Reference Appendix RA4.)
5. If a fire wall interrupts the first 5 feet of pipe, the insulation may be interrupted at the wall and continued on the other side.
6. Insulation for pipe elbows should be mitered and insulation for tees should be notched. (See Reference Appendix RA4.)

**Figure 5-5: Pipe Insulation Requirements First Five Feet From Water Heater**

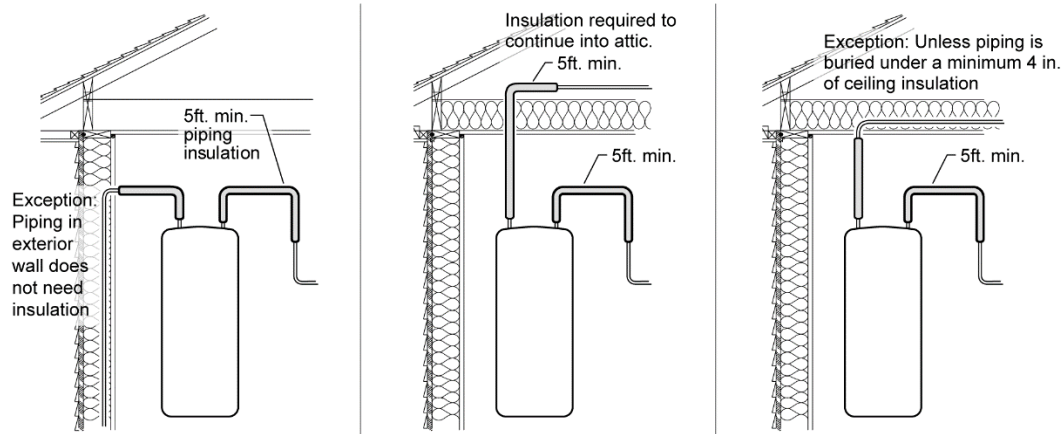

Source: California Energy Commission

**Table 5-8: Pipe Insulation Thickness Requirements for Space Conditioning, Solar Water Heater Collector Loops, and Steam & Hydronic Heating Distribution**

Insulation properties are given (inches and R-value) by fluid temperature (degrees Fahrenheit) and nominal pipe diameter (inches).

Operating Temperature Range	Thickness for <1" pipe	R-value for <1" pipe	Thickness for 1 to <1.5" pipe	R-value for 1 to <1.5" pipe	Thickness for 1.5 to <4" pipe	R-value for 1.5 to <4" pipe
201–250	2.5	21	2.5	20	2.5	17.5
141–200	1.5	11.5	1.5	11	2.0	14
105–140	1.0	7.7	1.5	12.5	1.5	11
40–60	0.75	6	0.75	5	1.0	7
<40	1.0	8.5	1.5	14	1.5	12

Source: Excerpt From Table 120.3-A of the Energy Codes

**5.3.6.2 Insulation Protection**

**§150.0(j)2**

If hot water piping insulation is exposed to weather, it must be protected from physical damage, ultraviolet (UV) light deterioration, and moisture. Insulation is typically protected by aluminum, sheet metal, painted canvas, plastic cover, or a water-retardant coating that shields from solar radiation. Adhesive tape should not be used as insulation cover because removal of the tape will damage the integrity of the original insulation during preventive maintenance.



### **Example 5-2 – Distribution Systems**

#### **Question:**

When I'm insulating the pipes for a recirculating water heating system, I understand that I must insulate the entire length of hot water pipes that are part of the recirculation loop. Do I also need to insulate the runouts?

#### **Answer:**

Yes, per the California Plumbing Code, all domestic hot water piping shall be insulated.

### **Example 5-2 – Recirculation System Insulation**

#### **Question:**

Can I get pipe insulation credit for a recirculating water heating system?

#### **Answer:**

Not for systems serving a single dwelling unit. Recirculating water heating systems have a mandatory insulation requirement for the recirculating section. . All the circulation loop pipes in one location type (for example, inside, outside, underground) must be insulated to the higher level to qualify.

### **Example 5-3 – Pipe Insulation**

#### **Question:**

I thought I was supposed to insulate the first 5 feet of hot and cold water piping from the water heater. Did I misunderstand?

#### **Answer:**

Yes. Prior code cycles did require this but based on Section 609.11 of the California Plumbing Code, all domestic hot water pipes must be insulated. There is no requirement for cold water pipes to be insulated.

---

## **5.4 Prescriptive Requirements for Water Heating**

### **5.4.1 Single Dwelling Units**

*§150.1(c)8*

There are three options to comply with the prescriptive water heating requirements for newly constructed single dwelling units. For all three options, the water heater must comply with the mandatory requirements for water heaters. (See Section 5.3.) If a recirculation distribution system is installed, only demand recirculation systems with manual control pumps are allowed. The three options are described below.

Option 1: Install a single 240 volt heat pump water heater. The storage tank shall be located in the garage or conditioned space. In addition, the building must comply with the following:

1. A compact hot water distribution design meeting the Basic Compact Design in climate zones 1 and 16.
2. A HERS-verified drain water heat recovery system in climate zone 16.

Option 2: Install a single 240 volt heat pump water heater that meets the requirements of NEEA Advanced Water Heater Specification Tier 3 or higher. For climate zone 16, the storage tank must be located in the garage or conditioned space and install a drain water heat recovery system that meets field verification described in Appendix RA3.6.9.

Option 3: A solar water-heating system with electric backup that meets the installation criteria specified in Reference Residential Appendix RA4.4.20 and with a minimum annual solar savings fraction of 0.7.

In Climate Zones 1 & 16, then one or more additional building features must be installed as shown above. These features require consideration at the start of the design process and must be coordinated with several players including the designer, general contractor, sub-contractor, and HERS Rater.

The list of [qualified product list of NEEA HPWH](https://nea.org/img/documents/qualified-products-list.pdf) can be found here:

<https://nea.org/img/documents/qualified-products-list.pdf>

For more information on HERS-verified compact hot water distribution design, see Section 5.6.2.4. HERS-verified compact hot water distribution designs are included in Option 1 described above.

For more information on HERS-verified drain water heat recovery system requirements, see Example 5-9 below and Section 5.6.2.5 of this chapter. The Reference Appendix contains the requirements for the proper installation of the system (see RA4.4.21). A HERS-verified drain water heat recovery system is included in Options 1 and 2 described above.

Unless one of the three exceptions can be claimed, any other water heating system that differs from the three options described above does not meet the prescriptive requirements, but can be installed using the performance approach as described in Section 5.5. The three Exceptions are:

1. A gas or propane instantaneous water heater of up to 200,000 Btu/h and no storage tank may be used in Climate Zones 3, 4, 13, & 14.
2. An electric instantaneous water heater with point-of-use distribution (RA4.4.5) is allowed in new dwelling units of up to 500 ft<sup>2</sup> conditioned floor area
3. For new dwelling units with 1 or fewer bedrooms, a 120V HPWH may be used instead of a 240V HPWH.

For additions, the prescriptive requirements apply only if a water heater is being installed as part of the addition. In those cases, the prescriptive requirements would apply only to the space that is added, not the entire building.

For alterations where an existing water heater is being replaced, the water heater must meet the mandatory equipment efficiency requirements. Pipe insulation requirements do not apply to inaccessible piping. See Chapter 9 for a more detailed explanation for the water heating alteration requirements.

---

### **Example 5-5 – Alterations**

Question:

If my house has an electric-resistance water heater and I plan to upgrade my water heater, do I need to install a gas instantaneous or gas storage water heater?

Answer

No, because the existing water heater is an electric water heater, then a consumer electric water heater that meets the requirements of California’s Appliance Efficiency Regulations can replace the existing water heater. If installing new piping to the water heater, then you will need to comply with the mandatory pipe insulation requirements. See Section 5.3.5.1 for more information on pipe insulation requirement and Chapter 9 for more information on alterations.

### **Example 5-6– Additions**

Question:

I am building an addition to my home that will be a self-contained apartment. Do I need to comply with the prescriptive water heater requirements?

Answer:

If the addition will include a water heater, or if it will be connected to the existing hot water distribution system to supply hot water to the apartment, then you must comply with the standards either through the prescriptive or performance path. If taking the performance approach, you can install any type of water heater as long as it 1) meets the requirements of California’s Appliance Efficiency Regulations and 2) does not exceed the water heating energy budget for the self-contained building. If you were adding only an additional room with hot water and not a self-contained dwelling, then the water heating budget would be based on the existing building plus addition. (See Section 5.5.)

### **Example 5-7 – Heat Pump Water Heaters**

Question:

For a new home, can I install an electric water heater? Do I have to perform calculations to show compliance?

Answer:

Yes, electric heat pump water heaters (HPWHs) can be used for both prescriptive and performance compliance. Calculation is not necessary using the prescriptive compliance path. There are 2 prescriptive options (Options 1 and 2 in Section 5.4.1 above) for HPWH. Option 2 is the simplest option, which requires the installation of a NEEA Tier 3 or higher HPWH in the garage or conditioned space. For climate zones 2 through 15, no additional requirement is needed for compliance. For climate zones 1 and 16, compact hot water distribution and/or a drain water heat recovery system are also required, depending on the climate zone. For more details, see Section 5.4.1 above.

For performance compliance, the characteristic of the HPWH must be modeled, such as rated UEF or make and model of the HPWH if it is NEEA rated.

### **Example 5-8 – Drain Water Heat Recovery**

Question:

I'm in the schematic design phase for a single-family home. I intend to include drain water heat recovery in my design and to follow the prescriptive path. What are the primary design issues I should consider?

Answer:

If you follow the prescriptive path, drain water heat recovery is required in climate zones 1 and 16. For all other water heater types, you could follow the performance path and obtain compliance credit within an energy model calculation. In any case, the initial design issues are related to the selection of an appropriate drain water heat recovery model (i.e. horizontal or vertical type, minimum rated effectiveness, and diameter and length), and designing the layout of the system. If your residence is single story, then a horizontally rated unit is required. If your residence has multiple stories, then the unit can be horizontally or vertically rated. In any case, the required minimum rated effectiveness is 42 percent. The diameter of the unit should match the diameter of the drainpipe. Added length improves effectiveness but requires more space. In terms of the system layout, the unit must recover heat from at least the master bathroom shower and must at least transfer that heat either back to all the respective showers or the water heater. If you desire to maximize savings, you should place the unit in a drain line that serves all the showers, and you should pipe the preheated water to the cold side of all the shower mixing valves and the make-up water inlet of the water heater. This is known as an equal flow configuration (see Figure 5-3), since the preheated water flow rate will match the drain water flow rate.

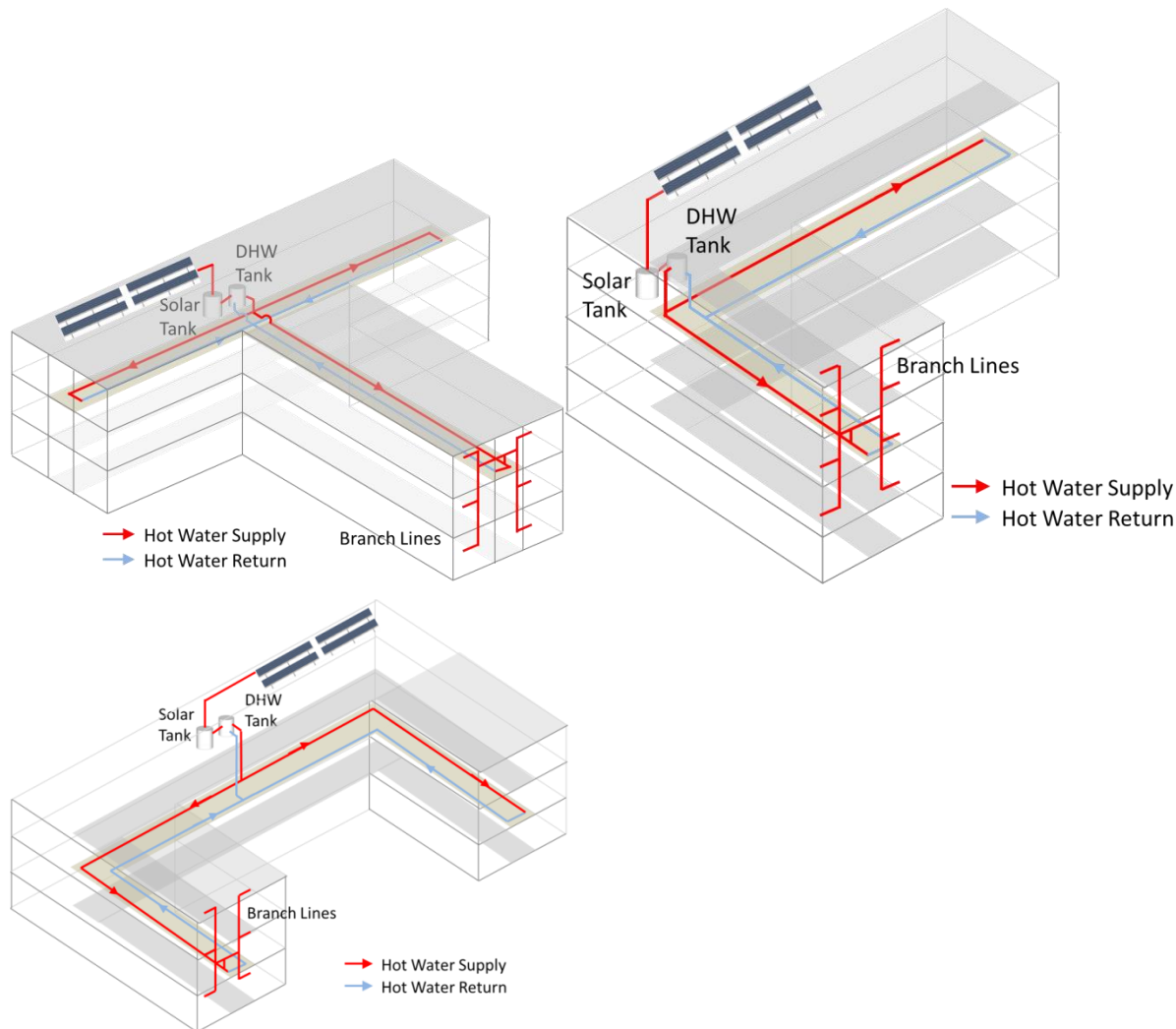

#### 5.4.1.1 Demand Recirculation Control

The prescriptive requirement for domestic hot water systems with recirculation distribution systems requires the installation of a demand recirculation control to minimize pump operation and heat loss from pipes. Demand controls for recirculation systems operate by sensing hot water demand and recirculation return temperatures. The temperature sensor should be installed at the farthest end of the recirculation loop close to the last branch pipe.

Any system not meeting these prescriptive requirements must instead meet the standard design building energy budget that is established by the energy efficiency performance of a HPWH or gas instantaneous water heater that meets the requirements of California's *Title 20 Appliance Efficiency Regulations* or must follow the performance compliance method for the building as a whole.

## **5.5 Performance Approach Compliance for Water Heating**

### **5.5.1 Energy Budget Calculation**

When the performance compliance method is used, the water heating energy budget is based on the performance of a heat pump water heater in most climate zones. In addition to a heat pump water heater, a compact hot water distribution system is required in climate zone 1 and 16 and a drain water heat recovery device also is required in climate zone 16. The water heating energy budget in climate zones 3, 4, 13, or 14, is based on the performance of a gas instantaneous water heater. Both gas and electric water heaters used in the standard design meet the minimum requirements in California's *Title 20 Appliance Efficiency Regulations* Section 1605.1(f) for federally regulated appliances

The computer performance approach allows for the modeling of water heating system performance by taking into account building characteristics, climate, system type, efficiency, and fuel type. The standard design water heating budget is defined by the corresponding prescriptive requirements. The performance method allows for modeling alternative water heater and distribution system combinations. Some of these options will offer compliance credits, and others will result in penalties.

### **5.5.2 Systems Serving a Single Dwelling Unit**

In the case of single dwelling units, any type or number of water heaters supported by the software can be installed. The calculated energy use of the proposed design is compared to the standard design energy budget based on either a single gas instantaneous water heater with a standard distribution system for gas water heaters, or a HPWH with compact distribution system and drain water heat recovery for electric water heaters. Adding multiple water heaters to a single-family design will generally result in an energy penalty in the water heating budget that must be offset elsewhere in the total energy budget.

A standard distribution system serving a single dwelling unit does not incorporate a pump for hot water recirculation and does not take credit for any additional DHW design features. All mandatory pipe insulation requirements must be met, such as insulating all hot water pipes. Alternative distribution systems are compared to the standard design case by using distribution system multipliers (DSMs), which effectively rate alternative options.

Table 5-9 lists all the recognized distribution systems that can be used in the performance approach with the assigned distribution multiplier. The standard distribution system has a multiplier of 1.0. Distribution systems with a multiplier less than 1 represent an energy credit, while distribution systems with a multiplier greater than 1 are counted as an energy penalty. For example, pipe Insulation with HERS Inspection Required (PIC-H) has a multiplier of 0.8. That means that it is modeled at

20 percent less distribution loss than the standard distribution system. For more information or installation requirements on any of the systems, refer to Section 5.6.

**Table 5-9: Applicability of Distribution Systems Options Within a Dwelling Unit**

<b>Distribution System Types</b>	<b>Assigned Distribution System Multiplier</b>	<b>Systems Serving a Single Dwelling Unit</b>	
<b>No HERS Inspection Required</b> Trunk and Branch -Standard (STD)	1.0	Yes	
<b>No HERS Inspection Required</b> Compact Design – Basic (CHWDS)	0.7	Yes	
<b>No HERS Inspection Required</b> Parallel Piping (PP)	1.1	Yes	
<b>No HERS Inspection Required</b> Point of Use (POU)	0.3	Yes	
<b>No HERS Inspection Required</b> Recirculation: Non-Demand Control Options (R-ND)	9.8	Yes	
<b>No HERS Inspection Required</b> Recirculation with Manual Demand Control (R-Dman)	1.75	Yes	
<b>No HERS Inspection Required</b> Recirculation with Motion Sensor Demand Control (R-DAuto)	2.6	Yes	
<b>HERS Inspection Required</b> Pipe Insulation (PIC-H)	0.85	Yes	
<b>HERS Inspection Required</b> Parallel Piping with 5’ maximum length (PP-H)	1	Yes	
<b>HERS Inspection Required</b> Compact Design - Expanded (CHWDS-H)	0.3 – 0.7 <sup>1</sup>	Yes	
<b>HERS Inspection Required</b> Recirculation with Manual Demand Control (R-Drmc-H)	1.6	Yes	

<b>HERS Inspection Required</b> Recirculation with Motion Sensor Demand Control (RDRsc-H)	2.4	Yes	
--	-----	-----	--

1. The multiplier for the Compact Design – Expanded credit varies depending on the home’s floorplan and water heater location. See Section 5.6.2.4 for more information.

### 5.5.3 Treatment of Water Heater Efficiency

For information on how water heater efficiency is considered in terms of modeling energy performance using the compliance software tool, please refer to the *Residential Alternative Calculation Method (ACM) Reference Manual*.

### 5.5.4 Compliance Issues

Water heating is becoming more important to overall building compliance as building envelope performance and mechanical efficiency improve. When the performance approach is used, a high-efficiency water heater and an efficient distribution system can significantly affect the overall performance margin of a building, especially in the milder climates like Climate Zones 4 through 9, where water heating typically represents a larger fraction of the overall energy budget.

Asking for a cut sheet on the installed equipment to verify efficiency is a simple shortcut to checking compliance. When used in a combined hydronic system, it is important to check the capacity of the system to verify that both space and water heating loads can be met.

---

## 5.6 Distribution Systems

### 5.6.1 Types of Water Heating Distribution Systems

The water heating distribution system is the configuration of piping (and pumps and controls in the case of recirculating systems) that delivers hot water from the water heater to the end-use points within the building. For systems designed for single-family buildings, the system will resemble one of the system types described below under dwelling unit distribution systems. . The installation of a hot water distribution system that does not meet all the installation guidelines discussed in this compliance manual and in the Reference Appendix RA3 and RA4 must either (a) have the deficiencies corrected, or (b) use the performance approach and compensate for the compliance penalty. In all cases, the locations of the water heaters and fixtures should be given consideration at the beginning of building design. By minimizing the length of distribution piping, energy use, water waste, wait time for hot water and construction cost can all be reduced.

### 5.6.2 Systems Serving a Single Dwelling Unit

#### 5.6.2.1 Standard Distribution System (Trunk-and-Branch and Mini-manifold



### Configurations)

The most basic plumbing layout, and the reference design in the performance approach, is represented by the conventional trunk-and-branch layout. This layout of a trunk-and-branch system may include one or more trunks, each serving a portion of the building. The trunks are subdivided by branches that serve specific rooms, and these are in turn divided into twigs that serve a particular point of use. This distribution system class includes mini-manifold layouts (Figure 5-9), which incorporate trunk lines that feed remote manifolds that then distribute water via twigs to the end-use points. A standard distribution system cannot incorporate a pump for hot water recirculation. Piping cannot be run up to the attic and then down to points of use on the first floor.

**Figure 5-9: Mini-manifold Configuration**

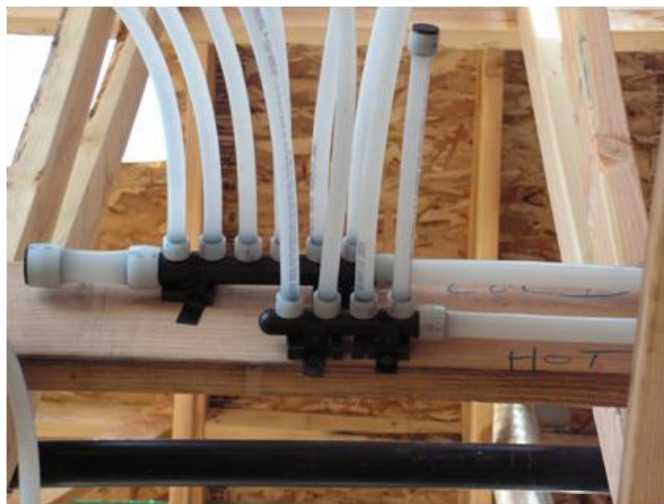

- *Installation Criteria and Guidelines*

No pumps may be used to recirculate hot water with the standard distribution system. All applicable mandatory features must be met. When designing a trunk-and-branch system, the concern is keeping all segments of the system as short and as small a diameter as possible. Even an insulated pipe will lose most of the stored heat within 30 minutes. The other issue to consider is that if hot water gets into a cold water line, all the water in the pipe must be discharged, and up to an additional third of the volume of hot water will be needed to heat the pipe so that the water arriving at the point of use will be the desirable temperature. The requirements and guidelines for the installation of the standard distribution system are included in Reference Appendix RA3 - Residential Field Verification and Diagnostic Testing Protocols and RA4 – Eligibility Criteria for Energy Efficiency Measures.

#### 5.6.2.2 Central Parallel Piping System

The primary design concept in a central parallel piping system is an insulated main trunk line that runs from the water heater to one or more manifolds, which then feeds use points with 1/2" or smaller plastic piping. The traditional central system with a single

manifold must have a maximum pipe run length of 15 feet between the water heater and the manifold. With the advent of mini-manifolds, the central parallel piping system can now accommodate multiple mini-manifolds in lieu of the single central manifold, provided that a) the sum of the piping length from the water heater to all the mini-manifolds is less than 15 feet and b) all piping downstream of the mini-manifolds is nominally ½ inch or smaller.

- *Installation Criteria and Guidelines*

All applicable mandatory measures must be met. Piping between the water heater and the manifold must be insulated, and all branch piping past the framing member from the manifold must be insulated. Piping from the manifold cannot run up to the attic and then down to points of use on the first floor. The intent of a good parallel piping design is to minimize the volume of water entrained in piping between the water heater and the end-use points, with a focus on reducing the length of the ¾-inch or 1-inch line from the water heater to the manifold(s). To encourage reducing the pipe length between the water heater and manifold, there is a distribution system compliance credit for installations that are HERS-verified to have no more than 5 feet of piping between the water heater and the manifold(s). The manifold feeds hot water use points with 3/8 or 1/2 inch PEX tubing. (Check with enforcement agencies on the use of 3/8-inch piping in the event that it is prohibited without engineering approval.) The adopted requirements for installation guidelines are included in RA3 and RA4.

### 5.6.2.3 Point of Use

A *point-of-use distribution system design* significantly reduces the volume of water between the water heater and the hot water use points. Use of this type of system requires a combination of good architectural design (that is, water heater location adjacent to hot water use points), an indoor mechanical closet, or the use of multiple water heaters. Figure 5-10 provides an example of the latter approach where three water heaters are installed close to the use points.

- *Installation Criteria and Guidelines*

All applicable mandatory requirements must be met, and the distance between the water heater and any fixture using hot water cannot exceed the length specified in Table 5-10 below. The adopted requirements for installation guidelines are included in RA3 and RA4. All water heaters and hot water fixtures must be shown on plans submitted for a local building department plan check.

**Figure 5-10: Point-of-Use Distribution System**

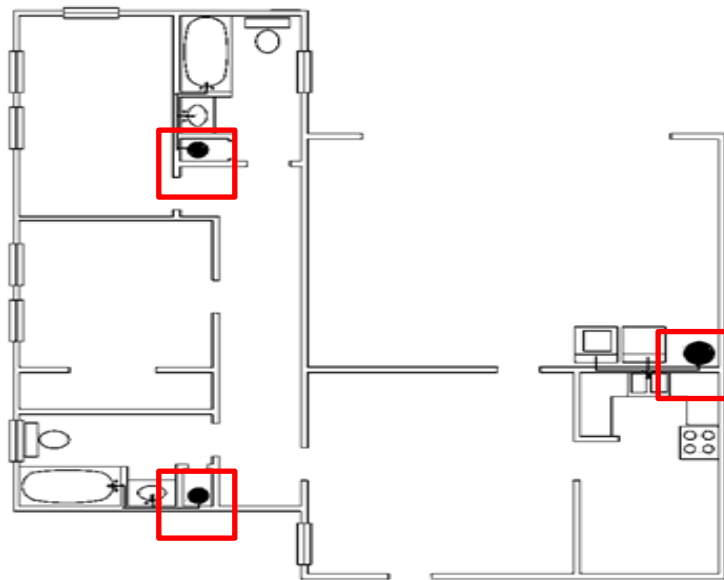

Source: 2019 CASE Initiative: Compact Hot Water Distribution

**Table 5-10: Point-of-Use Distribution System**

Size Nominal, Inch	Length of Pipe (feet)
3/8"	15
1/2"	10
3/4"	5

**5.6.2.4 Compact Hot Water Distribution System - Basic Credit and HERS-Verified Compact Hot Water Distribution System - Expanded Credit**

The intent of a compact hot water distribution system design is to reduce the size of the plumbing layout by bringing the water heater closer to hot water use points than is typical in standard homes. Through this process, energy and water will be saved, and homeowners will experience reduced hot water waiting times. This compliance option is applicable only to new single-family home.

Installed hot water distribution systems are often much larger than needed in terms of excessive pipe length and oversized pipe diameter. A design consideration that often is overlooked is the location of the water heater relative to hot water use points. Figure 5-11 below shows a common production home layout with the water heater in the corner of the garage and hot water use points in each corner of the house.

A more effective hot water distribution system design is shown in Figure 5-12. In the figure, the location of the water heater is near the kitchen, bathrooms and laundry

area. The location of hot water use points plays an integral role in achieving the benefits associated with a compact distribution system design.

Eligible compact hot water distribution designs can generate a compliance credit using the performance approach. There are two versions of the Compact Design credit. Basic Credit does not require HERS verification, while Expanded Credit requires field verification by a HERS Rater. Qualification for both credits is based on using a plan view, straight-line measurement to calculate a “Weighted Distance” to key hot water use points including the master bath, kitchen, and remaining furthest hot water fixture from the water heater. If this resulting Weighted Distance is less than a Qualification Distance (dependent on floor area, number of stories in the dwelling unit, and number of water heaters), then the plan is eligible for the Basic Credit. The Basic Credit does not require any further verification steps to secure the compliance credit. If the builder chooses to pursue an Expanded Credit, additional energy savings will be recognized under the performance method, however there are several HERS-verification requirements that must be met.

**Figure 5-11: “Common” Production Home House Layout**

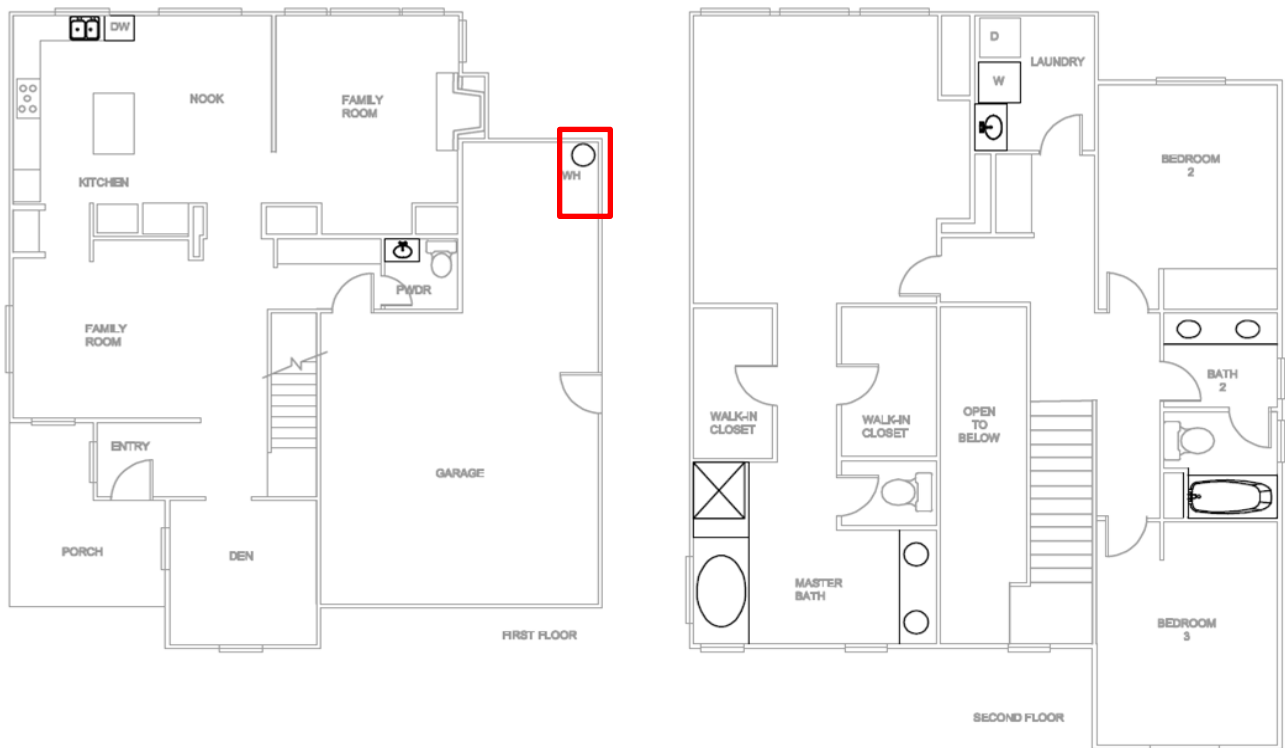

Source: 2019 CASE Initiative: Compact Hot Water Distribution

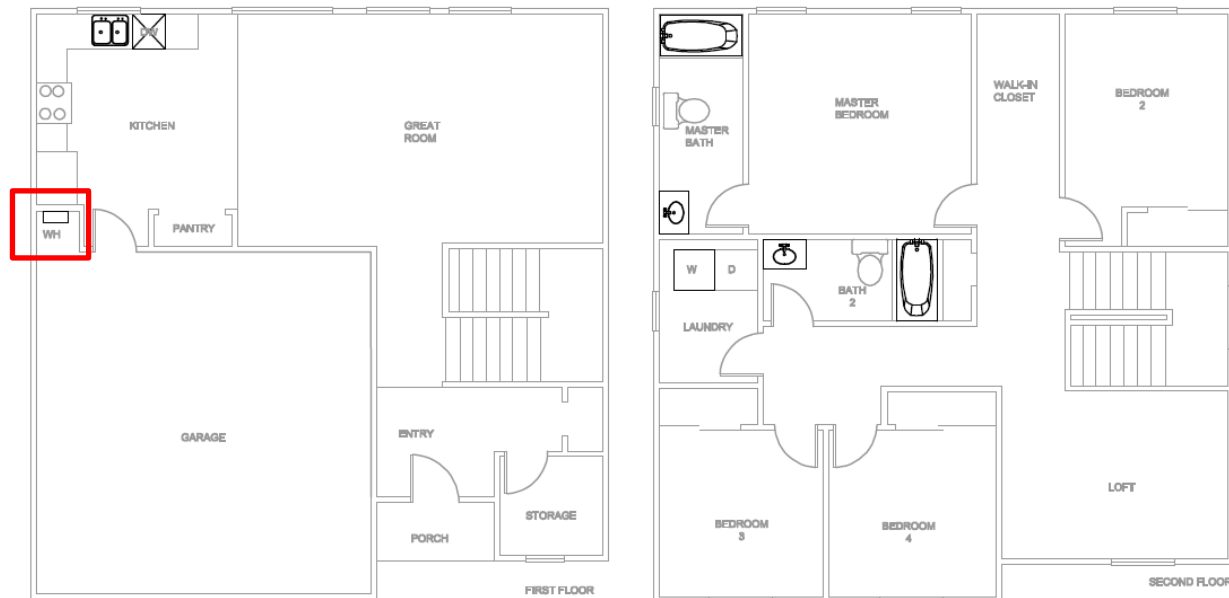
**Figure 5-12: Compact Design Distribution System**

Source: 2019 CASE Initiative: Compact Hot Water Distribution

- Weighted Distance Calculation Method

Calculation of the Weighted Distance metric depends on whether it is a standard non-recirculating distribution system or a house with a recirculation distribution system.

The basis of the calculation is a plan-view, straight line measurement from the water heater to the center of the use point fixture in three rooms of the house. It is calculated using the following equation.

$$\text{Weighted Distance} = x * d_{\text{MasterBath}} + y * d_{\text{Kitchen}} + z * d_{\text{FurthestThird}}$$

where,

**x, y, and z** = Weighted Distance coefficients (unitless), see Table 5-11.

**d\_MasterBath** = The plan view, straight line distance from the water heater to the furthest fixture served by that water heater in the master bathroom (feet).

**d\_Kitchen** = The plan view, straight line distance from the water heater to the furthest fixture served by that water heater in the kitchen (feet).

**d\_FurthestThird** = The plan view, straight line distance from the water heater to the furthest fixture served by that water heater in the furthest room<sup>1</sup> in the house (feet).

Table 5-10 shows the values for the coefficients depending on the type of distribution system.

**Table 5-11: Weighted Distance Coefficients**

Distribution System	x	y	z
Non-Recirculating	0.4	0.4	0.2
Recirculating	0.0	0.0	1.0

Note that the calculations are based on horizontal plan view distance measurements from the center of the water heater to the center of the use point in the designated location. Vertical length (For example, the vertical distance from the first to second floor) is neglected in the calculations. Use points that are located on floors different than the water heater would have their location translated to the appropriate floor.

In houses with multiple water heaters, the Weighted Distance “z term” calculation is performed for each water heater to arrive at a FurthestThird term averaged over each of the “n” water heaters installed. For a non-recirculating distribution system, the resulting Weighted Distance calculation would include the Master Bath, the Kitchen and an average of the FurthestThird term for each of the installed water heaters. (For recirculating systems, similarly the FurthestThird term would represent an average across the “n” water heaters.)

The calculated Weighted Distance input cell would be activated in the compliance software if the user selected either the Basic CHWDS Credit or the Expanded Credit.

Figure 5-13 shows an example weighted distance calculation for an 1,814 square foot two-story house with a standard non-recirculating distribution system. The design locates the water heater on the exterior wall, as shown by the red oval. The dotted blue lines and ovals represent translating the fixtures on the second floor to the first floor, neglecting the vertical distance. The red lines and listed distances represent the distance from the water heater to each fixture used in the calculation. The Weighted Distance calculation for this example is shown below Figure 5-13. Figure 5-14 shows a similar calculation for a centrally located water heater.

---

<sup>1</sup> Because the master bath and kitchen represent unique defined use points, the d\_FurthestThird fixture must not be located in either of these rooms. The laundry room is excluded and should not be used as the furthest third room. In some multifamily cases, there may not be another qualifying use point, in which case the d\_FurthestThird term equals zero.

**Figure 5-13: Weighted Distance Calculation for the 1,814 Plan with a Conventionally Located Water Heater**

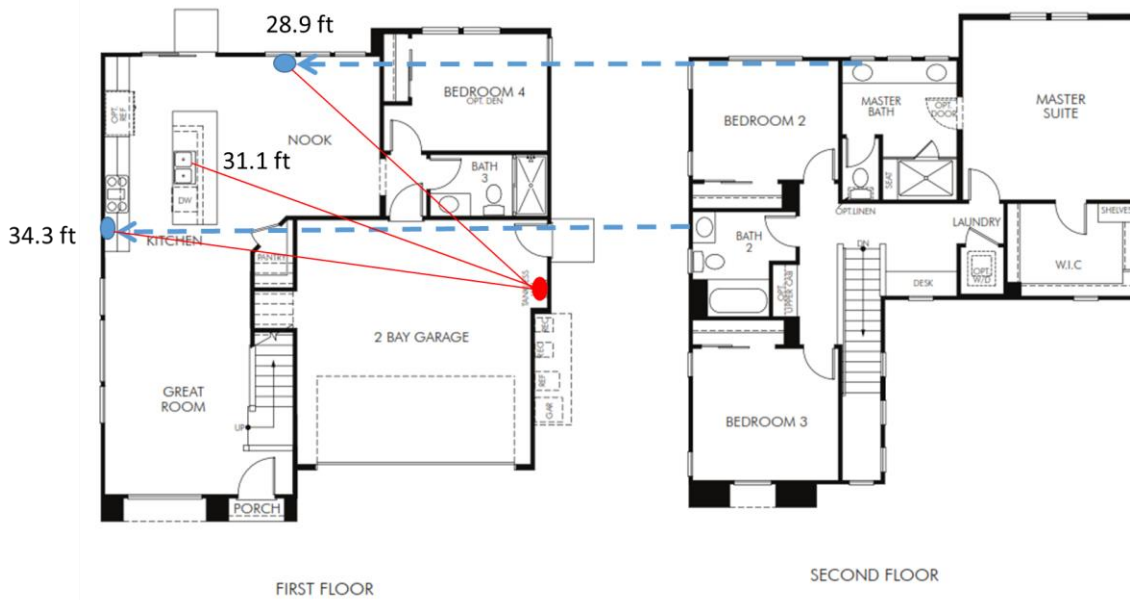

$$\text{Weighted Distance} = 0.4 * 28.9 \text{ ft} + 0.4 * 31.1 \text{ ft} + 0.2 * 34.3 \text{ ft} = 30.9 \text{ ft}$$

Source: 2019 CASE Initiative: Compact Hot Water Distribution

**Figure 5-14: Weighted Distance Calculation for the 1,814 Plan with a Centrally Located Water Heater**



$$\text{Weighted Distance} = 0.4 * 12.9 \text{ ft} + 0.4 * 11.8 \text{ ft} + 0.2 * 16.1 \text{ ft} = 13.1 \text{ ft}$$

Source: 2019 CASE Initiative: Compact Hot Water Distribution

#### 5.6.2.5 Drain Water Heat Recovery System

A drain water heat recovery system recovers heat that would otherwise be lost down the drain during showers, and transfers that heat back to the water heater, shower mixing valve, or both. These systems can help users comply with the water heating requirements in the Energy Codes using either the prescriptive or performance approach. To use these systems to comply with Energy Codes, the design and installation must be HERS-verified and meet the Reference Appendix RA4.4.21 requirements.

#### 5.6.2.6 Recirculation System – Non-Demand Control Options

This type of distribution system encompasses all recirculation strategies that do not incorporate a demand control to minimize recirculating pump operation. Under this category, recirculation system types include uncontrolled continuous recirculation, timer control, temperature control, and time/temperature controls. The intent is to clearly distinguish between recirculation system control options that result in very little daily pump operating time (demand control strategies) and the other strategies where the pump runs either continuously, or the run time is much more uncertain. Recirculation systems are known to save water, but the energy impact can be very high in a poorly designed and/or controlled system.

##### *Installation Criteria*

All piping used to recirculate hot water must be insulated to meet the mandatory requirements. Since the standards require pipe insulation for recirculating systems, these systems are not eligible for the pipe insulation credit. The recirculating loop within a dwelling unit must be laid out to be within 8 feet of all hot water fixtures served by the recirculating loop. As with all recirculation systems, an intelligent loop layout (loop in-board of hot water use points) and proper insulation installation are essential in obtaining desired performance. Piping in a recirculation system cannot be run up to the attic and then down to the points of use on the first floor. The adopted requirements for installation guidelines are included in Reference Appendices RA3 and RA4.

#### 5.6.2.7 Recirculation System – Demand Control

A *demand-control recirculation system* uses brief pump operation in response to a hot water demand “signal” to circulate hot water through the recirculation loop. The system must have a temperature sensor, typically located at the most remote point of the recirculation loop. Some water heaters have temperature sensors located within the water heater. The sensor provides input to the controller to terminate pump operation when the sensed temperature rises. Typical control options include manual push button controls or occupancy sensor controls installed at key use areas (bathrooms and kitchen). Push button control is preferred from a performance perspective, since it eliminates “false signals” for pump operation that an occupancy sensor could generate. The adopted requirements for installation guidelines are included in Reference Appendices RA3 and RA4.



### *Installation Criteria*

All criteria listed for continuous recirculation systems apply. Piping in a recirculation system cannot be run up to the attic and then down to points of use on the first floor.

Pump start-up must be provided by a push button or occupancy sensor. Pump shutoff must be provided by a temperature sensing device that shuts off the pump when the temperature sensor detects no more than 10 degree rise above the initial temperature of water in the pipe or when the temperature reaches 102 degrees F. Moreover, the controls shall limit the maximum pump run time to five minutes or less.

Push buttons and sensors must be installed in all locations with a sink, shower, or tub, with the exception of the laundry room.

Plans must include a wiring/circuit diagram for the pump and timer/temperature-sensing device and specify whether the control system is manual (push button or flow switch) or other control means, such as an occupancy sensor.

---

## **5.7 Combined Hydronic System**

### **5.7.1 Combined Hydronic**

Combined hydronic space heating systems use a single heat source to provide space heating and domestic hot water. The current modeling of these system types is fairly simplistic, treating water heating performance separately from the space-heating function.

---

## **5.8 Showerheads**

### **5.8.1 Certification of Showerheads and Faucets**

Maximum flow rates have historically been set by the *Appliance Efficiency Regulations*, and all faucets and showerheads sold in California must meet these standards. California's *Title 20 Appliance Efficiency Regulations* contain the maximum flow rate for showerheads and lavatory and kitchen faucets. Current flow requirements contained in the Title 24 Part 11 CALGreen Code set more efficiency levels. Installations of showerheads and faucets are mandatory under the CALGreen Code.

---

## **5.9 Solar Water Heating**

The water heating calculation method allows water heating credits for solar water heaters. Solar thermal systems save energy by using renewable resources to offset the use of conventional energy sources.

For single-dwelling solar thermal systems, systems must be Solar Rating and Certification Corporation (SRCC) or IAPMO R&T approved. Accepted testing procedures include either a fully approved system with OG-300 test results or a built up system

that uses the collector (OG-100) rating. For detailed instructions on installation of solar water heaters, refer to Reference Appendix RA4.4.20.

The [database of SRCC-certified equipment](#) is on the SRCC website at the following link:

[http://www.solar-rating.org/certification\\_listing\\_directory/index.html](http://www.solar-rating.org/certification_listing_directory/index.html)

The database of [IAPMO R&T-certified equipment](#) is on the IAPMO R&T website at the following link:

<http://www.iapmort.org/Pages/SolarCertification.aspx>

Figure 5-16 summarizes the process flow for demonstrating compliance via the prescriptive and performance approaches for solar thermal systems.

**Figure 5-16: Compliance Process for Solar Thermal System**

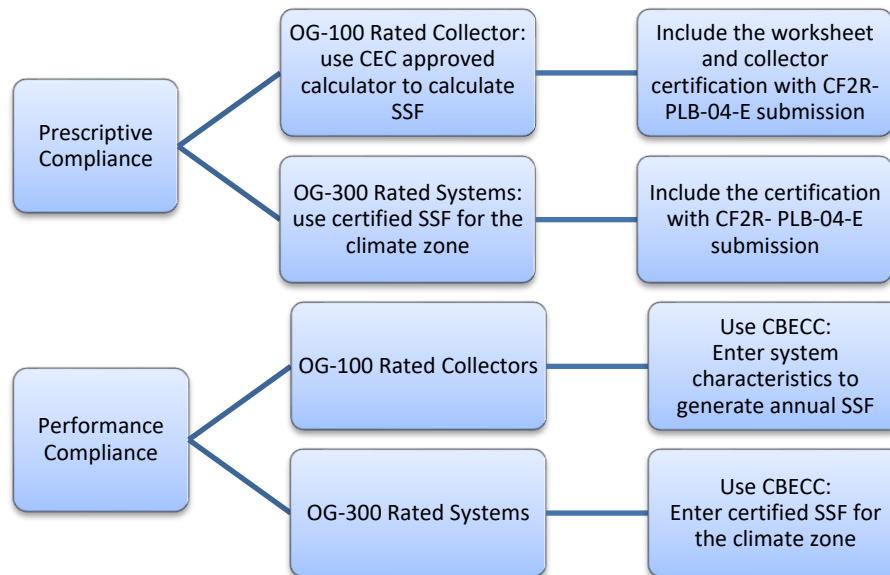

Regardless of the system type installed and compliance method chosen, mandatory requirements for pipe insulation apply as described in Section 5.3.5.1.

**5.9.1 Solar or Recovered Energy in State Buildings**

*§110.3(c)6*

All buildings constructed by the State of California shall have solar water-heating systems. The solar system shall be sized and designed to provide at least 60 percent of the energy needed for service water heating from site solar energy or recovered energy. There is an exception for buildings for which the DSA determines that water heating from recovered or site solar energy is economically or physically infeasible. See the Compliance Options section below for more information about solar water heating systems.

### 5.9.1.1 Solar-Ready Buildings Requirements

#### *§150.0(r) §110.1*

There are mandatory requirements for all buildings to be “solar ready.” The motivation behind having solar-ready requirements is to encourage future installations of photovoltaic and solar water-heating systems if these systems are not installed during the time when newly constructed buildings are built. Details on these solar ready requirements are in Chapter 7 – “Solar Ready Requirements” of this compliance manual. In summary, the elements to being solar-ready include:

1. A designated solar zone.
2. Designated conduit and plumbing paths.
3. Documentation for solar zone and paths on construction plans.
4. Adequate electric busbar and panel capacity.

---

## 5.10 Swimming Pool and Spa Heating

### 5.10.1 Swimming Pool and Spa Types

The Energy Codes include many additional requirements for residential swimming pool filtration equipment, which affect pump selection and flow rate, piping and fittings, and filter selection. These standards are designed to reduce the energy used to filter and maintain the clarity and sanitation of pool water.

### 5.10.2 Mandatory Requirements for Pools and Spas

Before any pool or spa heating system or equipment may be installed, the manufacturer must certify to the Energy Commission that the system or equipment complies with §110.4 and §110.5. The requirements include minimum heating efficiency according to the *Appliance Efficiency Regulations*, an on-off switch outside the heater, permanent and weatherproof operating instructions, no continuous pilot light, and no electric resistance heating. (See exceptions below.)

#### *§110.5*

Pool and spa heaters may not have continuously burning pilot lights.

#### *§110.4*

Outdoor pools and spas with gas or electric heaters shall have a cover installed. The cover should be fitted and installed during the final inspection.

There are two exceptions for electric heaters, which may be installed for:

1. Listed package units with fully insulated enclosures (for example, hot tubs), and with tight-fitting covers, insulated to at least R-6.

2. Pools or spas getting 60 percent or more of the annual heating from site solar energy or recovered energy.

#### 5.10.2.1 Pool Pump Requirements

For maximum energy efficiency, pool filtration should be operated at the lowest possible flow rate for a period that provides sufficient water turnover for clarity and sanitation. Auxiliary pool loads that require high flow rates, such as spas, pool cleaners, and water features, should be operated separately from the filtration to allow the filtration flow rate to be kept to a minimum.

*§150.0(p)1*

All pumps and pump motors shall comply with the specifications of the *Appliance Efficiency Regulations*.

The pool filtration flow rate may not be greater than the rate needed to turn over the pool water volume in 6 hours or 36 gallon per minute (gpm), whichever is greater. This means that for pools of less than 13,000 gallons, the pump must be sized to have a flow rate of less than 36 gpm, and for pools of greater than 13,000 gallons, the pump must be sized using the following equation:

$$\text{Max Flow Rate (gpm)} = \frac{\text{Pool Volume (gallons)}}{360\text{min.}}$$

These are maximum flow rates. Lower flow rates and longer filtration times are encouraged and will result in added energy savings.

Pools with auxiliary pool loads must use either a multispeed pump or a separate pump for each auxiliary pool load. For example, if a spa shares the pool filtration system, either a multispeed pump must be used or a separate pump must be provided to operate the spa. If the pool system can be served by one pump of less than 1 total horsepower (hp) in capacity, the pump may be single-speed.

Filtration pump motors must meet 10 CFR 431.465.

All pool pumps sold in California must be tested and listed with the Energy Commission according to the *Appliance Efficiency Regulations*. Pump manufacturers must list flow rate, power, and energy factor at each of three system curves. (See Figure 5-17.) For pools equal to or less than 17,000 gallons, a pump must be chosen such that the flow rate listed for Curve A is less than the 6-hour turnover rate. For pools greater than 17,000 gallons, a pump must be chosen such that the listed flow rate at Curve C is less than the 6-hour turnover rate.

**Figure 5-17: System Test Curves**

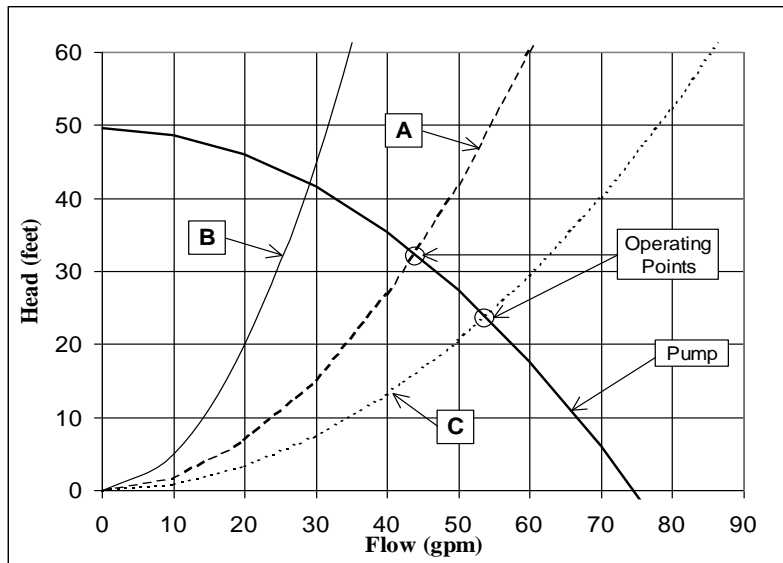

**5.10.2.2 Pool Pump Controls**

Pool controls are a critical element of energy efficient pool design. Modern pool controls allow for auxiliary loads such as cleaning systems, solar heating, and temporary water features without compromising energy savings.

*§110.4(b)*

A time switch or similar control mechanism must be installed as part of the pool water circulation control system that will allow all pumps to be set or programmed to run only during the off-peak electric demand period and for the minimum time necessary to maintain the water in the condition required by applicable public health standards.

*§150.0(p)1*

Multispeed pumps must have controls that default to the filtration flow rate when no auxiliary pool loads are operating. The controls must also default to the filtration flow rate setting within 24 hours and must have a temporary override capability for servicing.

**5.10.2.3 Pool Pipe, Filter, and Valve Requirements**

Correct sizing of piping, filters, and valves reduces overall system head, reduces noise and wear, and increases energy efficiency. Other mandatory requirements include leading straight pipe into the pump, directional inlets for mixing, and piping to allow for future solar installations.

*§110.4(b) and §150.0(p)2*

Pool piping must be sized according to the maximum flow rate needed for all auxiliary loads. The maximum velocity allowed is 8 feet per second (fps) in the return line and 6

fps in the suction line. Table 5-14 shows the minimum pipe sizes required by pool volume based on a 6-hour turnover filtration flow rate. These pipe sizes would need to be increased if there are auxiliary loads that operate at greater than the filtration flow rate. Conversely, they could be reduced if the pump is sized for greater than a 6-hour turnover filtration flow rate.

**Table 5-14: Hour Turnover Pipe Sizing**

<b>Pool Volume, min (gallons)</b>	<b>Pool Volume, max (gallons)</b>	<b>Minimum Pipe Diameter (in), return</b>	<b>Minimum Pipe Diameter (in), suction</b>
-	13,000	1.5	1.5
13,000	17,000	1.5	2.0
17,000	21,000	2.0	2.0
21,000	30,000	2.0	2.5
30,000	42,000	2.5	3.0
42,000	48,000	3.0	3.0
48,000	65,000	3.0	3.5

There must be a length of straight pipe that is greater than or equal to at least 4 times the pipe diameters installed before the pump. That is, for a 2-inch suction pump, there must be at least 8 inches of straight pipe before the pump strainer basket.

Traditional hard 90° elbows are not allowed. All elbows must be sweep elbows or a type of elbow that has a pressure drop less than the pressure drop of straight pipe with a length of 30 times the pipe diameters. For example, a 2-inch elbow must have a pressure drop less than a 5-foot length of a 2-inch straight pipe.

Field verification of sweep elbows may be performed by checking that the distance "w" of the installed sweep elbow is greater than that for a hard 90 elbow. (Refer to Figure 5-16.) The difference in measurement between the radial edge of one sleeve to the perpendicular side of the elbow is found to be distinct between sweep elbows and hard 90s. There is sufficient difference in distance "w" such that all sweep elbows exceed the minimum values listed in Table 5-15.

Figure 5-18 below illustrates "w" the dimension between the elbow sleeves, and Table 5-14 shows the minimum distances "w" for an acceptable sweep elbow.

**Figure 5-18: Measuring "W" at the Pool Site**

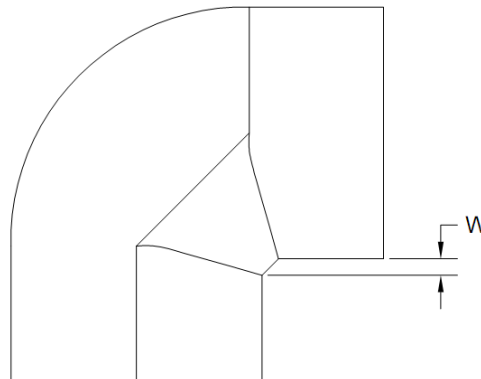

**Table 5-15: Pool Site Measurement for Sweep Elbows**

Pipe Diameter	Minimum W (inch)
1.5	3/8
2	1/2
2.5	5/8
3	3/4
4	1

Filters shall be sized using NSF/ANSI 50 based on the maximum flow rate through the filter. The filter factors that must be used are in ft<sup>2</sup>/gpm:

- a. Cartridge 0.375
- b. Sand 15
- c. Diatomaceous Earth 2

Backwash valves must be sized to the diameter of the return pipe or 2 inches, whichever is greater. Multiport backwash valves have a high-pressure drop and are discouraged. Low-loss slide and multiple three-way valves can provide significant savings.

The pool must have directional inlets to adequately mix the pool water.

If a pool does not use solar water heating, piping must be installed to accommodate any future installation. Contractors can choose one of three options to allow for the future addition of solar heating equipment:

1. Provide at least 36 inches of pipe between the filter and the heater to allow for the future addition of solar heating equipment.

2. Plumb separate suction and return lines to the pool dedicated to future solar heating.
3. Install built-up or built-in connections for future piping to solar water heating. An example of this would be a capped off tee fitting.

---

**Example 5-12 – Pool Covers****Question:**

My pool has both a solar heater and a gas heater. Do I need to install a pool cover?

**Answer:**

Yes. A cover is required for all pools with gas or electric heaters, regardless of whether they also have a solar heater.

**Example 5-13 – Pool Pump****Question:**

I have a 25,000-gallon pool and want to use a two-speed pump with a Curve C flow rate of 79 gpm on high speed and 39 gpm on low speed. Is this okay, and what size piping must I installed?

**Answer:**

The maximum filtration flow rate for a 25,000-gallon pool is 69 gpm by using equation [Max Flow Rate (gpm) = Pool Volume (gallons) / 360 minutes], so the pump is adequately sized, as long as a control is installed to operate the pump on low-speed for filtration. The maximum pipe size must be based on the maximum flow rate of 79 gpm. Referencing Table 5-9, you must use 2.5-inch suction and 2-inch return piping.

---

---

## 5.11 Compliance and Enforcement

Chapter 2 of this compliance manual addresses the compliance and enforcement process generally and discusses the roles and responsibilities of each of the major parties, the compliance forms, and the process for field verification and/or diagnostic testing. This section highlights compliance enforcement issues for water heating systems.

### 5.11.1 Design Review

The design review verifies that the certificate of compliance matches the plans and specifications for the proposed building. The certificate of compliance has a section where special features are listed. The following are water heating features that should be listed in this section of the certificate of compliance:

1. Any system type other than one water heater per dwelling unit
2. Non-NAECA large water heater performance



3. Indirect water heater performance
4. Instantaneous gas water heater performance
5. Distribution system type and controls
6. Solar system
7. Combined hydronic system

If any of these measures are called out on the certificate of compliance, special attention should be given to make sure that identical information is located on the plan set. Highlighting key concerns or adding notes will allow field inspectors to quickly catch any measures that should be installed that made a significant difference in compliance.

### **5.11.2 Field Inspection**

During construction, the contractor or the specialty contractors or both complete the necessary sections of the certificate of installation. For water heating, there is only one section to be completed where information about the installed water heating system is entered if complying prescriptively with the installation of a gas instantaneous, gas storage above 55 gallons, or a NEEA Tier-3 rated heat pump water heater. Additional documents will be needed to comply prescriptively for all other options. (See Appendix A.)

Inspectors should check that the number and types of water heating systems indicated on the installation certificates match the approved certificate of compliance. The distribution system is also significant and must correspond to plan specifications.

### **5.11.3 HERS Field Verification and/or Diagnostic Testing**

#### **5.11.3.1 Single Family**

HERS verification is required for all hot water distribution types that include options for field verification. The first type is alternative designs to conventional distribution systems that include parallel piping, demand recirculation, and automatic and manual on-demand recirculation. The second type is for compact distribution systems earning the expanded credit, which can be used only when verified by field verification. For all of the cases where HERS verification is required, the HERS Rater must verify that the eligibility requirements in RA3.6 for the specific system are met.

In addition, HERS-verified drain water heat recovery is an option for prescriptive compliance and as a compliance credit for the performance approach.

---

## **5.12 Glossary/Reference**

### **5.12.1 General Glossary/Reference for Water Heating**

Relevant terms are defined in Reference Joint Appendix JA1.

The following are terms that are either not defined in JA1 or expansions to the Appendix I definitions.

- A. **External tank insulation** can be applied to the exterior of storage type water heater tanks. When installed, water heater insulation should be applied to completely cover the exterior of the water heater but should not conceal controls or access ports to burners, obstruct combustion air openings, or interfere in any way with safe water heater operation. Insulation of top and bottom surfaces is not necessary.
- B. **Recovery energy** is the energy used to heat water.
- C. **Recovery load** is the load on the water heater due to hot water end uses and distribution losses.
- D. **Single dwelling unit** is a residence with a dedicated water heater. Single dwelling units can be a single-family home or an individual dwelling unit in a multifamily building, as long as each unit has a dedicated water heater.
- E. **Thermal efficiency** is defined in the *Appliance Efficiency Regulations* as a measure of the percentage of heat from the combustion of gas or oil that is transferred to the hot water as determined using the applicable test methods.
- F. **Uniform energy factor (UEF)** of water heater is the uniform energy descriptor used to describe the overall water heater efficiency as determined using the applicable test method in the *Appliance Efficiency Regulations*. Typical gas storage water heaters have typical UEFs of about 0.60-0.76, electric storage water heaters approximately 0.90, and gas instantaneous units approximately 0.80-0.94. It replaced the "energy factor" metric previously used for residential water heaters.

### 5.12.2 General Glossary/Reference for Swimming Pool and Spa

- A. **Flow rate** is the volume of water flowing through the filtration system in a given time, usually measured in gallons per minute.
- B. **Nameplate power** is the motor horsepower (hp) listed on the nameplate and the horsepower by which a pump is typically sold.
- C. **Pool pumps** usually come with a leaf strainer before the impeller. The pumps contain an impeller to accelerate the water through the housing. The motors for residential pumps are included in the pump purchase but can be replaced separately. The pumps increase the "head" and "flow" of the water. Head is necessary to move fluid through pipes, drains, and inlets, push water through filters and heaters, and project it through fountains and jets. Flow is the movement of the water used to maintain efficient filtering, heating, and sanitation for the pool.
- D. **Return** refers to the water in the filtration system returning to the pool. The return lines or return side, relative to the pump, can also be defined as the

pressure lines or the pressure side of the pump. Water in the returns is delivered back to the pool at the pool inlets.

- E. **Service factor.** The service factor rating indicates the percentage above nameplate horsepower at which a pump motor may operate continuously when full-rated voltage is applied and ambient temperature does not exceed the motor rating. Full-rated pool motor service factors can be as high as 1.65. A 1.5 hp pump with a 1.65 service factor produces 2.475 hp (total hp) at the maximum service factor point.
- F. **Suction** created by the pump is how the pool water gets from the skimmers and drains to the filtration system. The suction side and suction lines refer to the vacuum side of the pump. It is at negative atmospheric pressure relative to the pool surface.
- G. **Total dynamic head (TDH)** refers to the sum of all the friction losses and pressure drops in the filtration system from the pools drains and skimmers to the returns. It is a measure of the system's total pressure drop and is given in units of either psi or feet of water column (sometimes referred to as "feet" or "feet of head").
- H. **Total motor power** or T-hp, refers to the product of the nameplate power and the service factor of a motor used on a pool pump.
- I. **Turnover** is the act of filtering one volume of the pool.
- J. **Turnover time** (also called *turnover rate*) is the time required to circulate the entire volume of water in the pool or spa through the filter. For example, a turnover time of 6 hours means an entire volume of water equal to that of the pool will be passed through a filter system in six hours.

$$\text{Turnover Time} = \frac{\text{Volume of the pool}}{\text{Flow Rate}}$$

**TABLE OF CONTENTS**

- 6. Residential Lighting ..... 1
  - 6.1 Overview ..... 1
    - 6.1.1 What’s New for the 2022 Energy Code ..... 1
    - 6.1.2 Scope ..... 1
    - 6.1.3 Related Resources ..... 1
  - 6.2 Luminaire Requirements ..... 2
    - 6.2.1 Residential Luminaires – High Luminous Efficacy by Default ..... 3
    - 6.2.2 Residential Luminaires – Reference Joint Appendix JA8 Certified Light Sources ..... 4
    - 6.2.3 Recessed Downlight Luminaires in Ceilings ..... 5
    - 6.2.4 Enclosed Luminaires and Recessed Luminaires other than Ceiling-Recessed Downlight Luminaires..... 7
    - 6.2.5 Screw-Base Luminaires..... 7
    - 6.2.6 Navigation Lighting – Night Lights, Step Lights and Path Lights..... 7
    - 6.2.7 Lighting internal to Drawers, Cabinets, and Linen Closets ..... 7
    - 6.2.8 Blank Electrical Boxes ..... 10
  - 6.3 Indoor Lighting Control Requirements..... 10
    - 6.3.1 Lighting Control Functionality ..... 12
  - 6.4 Residential Outdoor Lighting Requirements..... 14
    - 6.4.1 Outdoor Luminaires ..... 14
    - 6.4.2 Outdoor Lighting Controls..... 15
    - 6.4.3 Internally Illuminated Address Signs..... 15
  - 6.5 Residential Garages..... 15
  - 6.6 Additions and Alterations ..... 16
  - 6.7 Compliance Documentation ..... 16
    - 6.7.1 Certificate of Installation (CF2R-LTG) ..... 16
  - 6.8 For Building Officials ..... 17
    - 6.8.1 Plans..... 17
    - 6.8.2 Compliance Documentation..... 18
  - 6.9 For Manufacturers – Certification to the Energy Commission ..... 18
    - 6.9.1 Luminaires, Lamps, and Other Light Sources Complying with JA8 and JA10  
19

6.9.2 Marking Designation, and Product Data Required for JA8-Certified  
Luminaires, Lamps and Light Sources..... 20

## 6. Residential Lighting

This chapter covers Title 24 California Code of Regulations, Part 6 (Energy Code), lighting requirements for single-family buildings (including single-family homes, duplexes, triples, and all townhomes). It is for builders, manufacturers, electrical contractors, lighting designers, energy consultants, enforcement agency staff, those working on behalf of enforcement agencies, and those who provide outreach and education about the Energy Code.

---

### 6.1 Overview

For single-family buildings and spaces, all lighting requirements are mandatory. The residential lighting requirements differ from the nonresidential requirements in that there are no lighting power allowance threshold for spaces, no required lighting power calculations, and no prescriptive method for showing compliance. There are luminaire requirements and lighting control requirements for residential lighting installations.

The residential luminaire requirements apply to permanently installed luminaires, including luminaires with interchangeable lamps. They do not apply to portable luminaires such as table lamps or freestanding floor lamps. The lighting control requirements are focused on dimming controls and automatic off controls requirements for applicable spaces.

All section (§) and table references in this chapter refer to sections and tables contained in the Energy Code.

#### 6.1.1 What's New for the 2022 Energy Code

- Requirements for indoor luminaires and indoor lighting controls have been reorganized according to the subject requirements to improve readability.
- The lumen maintenance and rated-life requirements from Joint Appendix JA8 have been eliminated.
- Requirements for previously low-rise residential family requirements have been moved to the new multifamily chapters. (Nonresidential Compliance Manual Chapter 11 addresses multifamily buildings.)

#### 6.1.2 Scope

The residential lighting requirements in the Energy Code apply to indoor and outdoor lighting for:

- Newly constructed single-family buildings.
- Additions and alterations to single-family buildings.

#### 6.1.3 Related Resources

The California Energy Commission and others prepare educational resources with information about residential lighting. The Energy Commission's online resources can

be found at [the online resource center](https://www.energy.ca.gov/programs-and-topics/programs/building-energy-efficiency-standards/online-resource-center) at <https://www.energy.ca.gov/programs-and-topics/programs/building-energy-efficiency-standards/online-resource-center>.

---

## 6.2 Luminaire Requirements

A luminaire, also known as a light fixture, is defined by §100.1 as a complete lighting unit consisting of a light source, such as a lamp or lamps, and the parts that distribute the light, position and protect the light source, and connect it to the power supply.

A lamp is a light bulb or similar separable lighting component. It is defined by §100.1 as an electrical appliance that produces optical radiation for visual illumination, with a base to provide an electrical connection between the lamp and a luminaire, and to be installed into a luminaire. The definition clarifies that a lamp is not a luminaire and is not an LED retrofit kit designed to replace components of a luminaire.

The 2022 Energy Code for residential lighting requires all permanently installed luminaires to be classified high luminous efficacy, as specified in §150.0(k). Permanently installed lighting is defined in §100.1 as luminaires that are affixed to land. Examples include:

- Lighting attached to walls, ceilings, or columns.
- Track and flexible lighting systems.
- Lighting inside permanently installed cabinets.
- Lighting attached to the top or bottom of permanently installed cabinets.
- Lighting attached to ceiling fans.
- Lighting integral to exhaust fans.
- Lighting integrated into garage door openers, if it is used as general lighting, is switched independently from the garage door opener, and does not automatically turn off after a pre-determined amount of time.

The following are examples of non-permanently installed lighting:

- Portable lighting as defined by §100.1 (including, but not limited to, table and freestanding floor lamps with plug-in connections).
- Lighting installed by the manufacturer in refrigerators, stoves, microwave ovens, exhaust hoods for cooking equipment, refrigerated cases, vending machines, food preparation equipment, and scientific and industrial equipment.
- Lighting integrated into garage door openers by the manufacturer, where the lights automatically turn on when the garage door is activated, and automatically turn off after a pre-determined amount of time.

Luminaires can be classified as high luminous efficacy by default or can be classified as high luminous efficacy if the luminaire or installed light source complies with Reference Joint Appendix JA8 requirements. Section 6.2.1 describes luminaires that are high luminous efficacy by default. Section 6.2.2 describes luminaires and light sources that must meet the requirements of Reference Joint Appendix JA8.

### 6.2.1 Residential Luminaires – High Luminous Efficacy by Default

Luminaires in any of the following categories are classified high luminous efficacy and do not have to comply with the requirements of Reference Joint Appendix JA8 (aka JA8 – refer to next section for details).

- a. Luminaires containing LED light sources that are installed outdoors.
- b. Inseparable solid-state lighting (SSL) luminaires containing colored light sources for decorative lighting purpose.
- c. Pin-based linear fluorescent luminaires or compact fluorescent luminaires using electronic ballasts.
- d. High intensity discharge (HID) light sources, including pulse-start metal halide luminaires and high pressure sodium luminaires.
- e. Luminaires with induction lamp and hardwired high frequency generator.
- f. Ceiling fan light kits that are subject to federal appliance regulations.

All other luminaire types must meet the JA8 requirements with the following exceptions:

1. Integrated device lighting, including lighting integral to exhaust fans, kitchen range hoods, bath vanity mirrors, and garage door openers.
2. Navigation lighting, such as night lights, step lights, and path lights less than 5 watts.
3. Cabinet lighting, including lighting internal to drawers, cabinetry, and linen closets with an efficacy of 45 lumens per watt or greater.

Table 6-1 summarizes the requirements for residential high luminous efficacy luminaires. There are luminaires automatically classified as high efficacy, luminaires that must use JA8-certified light sources or lamps (See Section 6.2.2), and recessed downlight luminaires in ceilings (See Section 6.2.3).



**Table 6-6-1 (Based on Table 150.0-A): Summary of Compliant Luminaire Types**

<b>Automatically High Luminous Efficacy Luminaires*</b>	<b>Lamps and Light Sources That Must be JA8-certified</b>	<b>Lamps and Light Sources That Must be JA8-Certified for Elevated Temperatures</b>
<ul style="list-style-type: none"> <li>• LED light sources installed outdoors</li> <li>• Inseparable solid-state lighting (SSL) luminaires containing colored light sources for decorative lighting purpose</li> <li>• Pin-based linear fluorescent or compact fluorescent light sources using electronic ballasts</li> <li>• High intensity discharge (HID) light sources including pulse-start metal halide and high pressure sodium light sources</li> <li>• Luminaires with induction lamp and hardwired high frequency generator</li> <li>• Ceiling fan light kits subject to federal appliance regulations</li> </ul>	<ul style="list-style-type: none"> <li>• Light sources installed in ceiling recessed downlight luminaires. (Screw bases are not allowed in ceiling recessed downlight luminaires.)</li> <li>• LED luminaires with integral sources</li> <li>• Screw-based LED lamps (A-lamps, PAR lamps, etc.)</li> <li>• Pin-based LED lamps (MR-16, AR-111, etc.)</li> <li>• Any light source or luminaire not listed elsewhere in this table</li> </ul>	<ul style="list-style-type: none"> <li>• Lamps and separable light sources in ceiling recessed downlight luminaires.</li> <li>• Lamps and separable light sources in enclosed luminaires.</li> </ul>

### 6.2.2 Residential Luminaires – Reference Joint Appendix JA8 Certified Light Sources

Luminaires not listed in the previous section must have an integral light source or removable lamp that meets the performance requirements of JA8. The requirements in JA8 ensure that new lighting technologies, like LEDs, provide energy-efficient light, while also maintaining performance characteristics that customers expect. In addition to setting minimum efficacy requirements, JA8 establishes performance requirements that ensure accurate color rendition, dimmability, and reduced noise and flicker during operation.

Luminaires with integral sources, such as LED luminaires, must be certified to the Energy Commission as meeting the JA8 requirements. Changeable lamps, such as those in screw-base luminaires, must also be certified to the Energy Commission.

Luminaires and lamps that have been certified to the Energy Commission must be marked with JA8-2022 or JA8-2022-E on the product. The JA8-2022-E marking indicates that the product has passed the more stringent ENERGY STAR Elevated Temperature Life test. This test ensures that the light source is appropriate for elevated temperature applications such as installation in enclosed or recessed luminaires.

Luminaires that can be classified as high luminous efficacy by meeting the requirements of JA8 include:

1. LED luminaires with integral light sources that are JA8-certified.
2. Ceiling recessed downlight luminaires with JA8-certified light sources (the luminaire must not contain screw-based lamp sockets).
3. Screw-based luminaires with JA8-certified lamps.
4. Low-voltage pin-based luminaires with JA8-certified lamps.

Almost any luminaire can be classified as high luminous efficacy if it is installed with a JA8 certified lamp or light source. The exception is recessed downlight luminaires in ceilings, which must meet additional requirements.

The Energy Commission maintains a database of certified JA8 certified luminaires, lamps, and light sources. The database can be accessed using a [Quick Search Tool](https://cacertappliances.energy.ca.gov/Pages/ApplianceSearch.aspx) at <https://cacertappliances.energy.ca.gov/Pages/ApplianceSearch.aspx> or an [Advanced Search](https://cacertappliances.energy.ca.gov/Pages/Search/AdvancedSearch.aspx) at <https://cacertappliances.energy.ca.gov/Pages/Search/AdvancedSearch.aspx>.

### 6.2.3 Recessed Downlight Luminaires in Ceilings

In addition to the high luminous efficacy requirements, there are several additional requirements for residential downlight luminaires that are recessed in ceilings.

**Figure 6-1 Recessed Downlight Luminaires in Ceiling**



Source: Image Courtesy of Lutron Electronics Co., Inc.

Recessed downlight luminaires are limited to specific light sources and lamp types. Recessed downlight luminaires:

1. Must contain light sources that are JA8-certified.
2. Must not contain screw-based lamps.
3. Must not contain light sources that are labeled not for use in enclosed luminaires or not for use in recessed luminaires.

All recessed downlight luminaires must contain a light source or lamp that is JA8-certified, such as an integral LED source or LED lamp. Screw-based lamps such as LED A-lamps or LED PAR lamps are not allowed. Pin-based lamps such as LED MR-16 lamps are allowed in recessed luminaires as long as they are JA8-certified.

In addition to the light source and lamp requirements listed, recessed downlight luminaires in ceilings must also meet all the following performance requirements:

1. Have a label that certifies the luminaire is airtight with air leakage less than 2.0 cubic feet per minute (cfm) at 75 Pascals when tested in accordance with ASTM E283 (exhaust fan housings with integral light are not required to be certified airtight); and
2. Be sealed with a gasket or caulk between the luminaire housing and ceiling, and have all air leak paths between conditioned and unconditioned spaces sealed with a gasket or caulk, or be installed per manufacturer's instructions to maintain airtightness between the luminaire housing and ceiling; and
3. Meet the clearance and installation requirements of California Electrical Code Section 410.116 for recessed luminaires which requires the following.
  - A recessed luminaire that is not identified for contact with insulation, non-Type IC, shall have all recessed parts spaced not less than 1/2 inch from combustible materials. The points of support and the trim finishing off the openings in the ceiling shall be permitted to be in contact with combustible materials.
  - A recessed luminaire that is identified for contact with insulation, Type IC, shall be permitted to be in contact with combustible materials at recessed parts, points of support, and portions passing through or finishing off the opening in the building structure.
  - Thermal insulation shall not be installed above a recessed luminaire or within 3 inches of the recessed luminaire's enclosure, wiring compartment, ballast, transformer, LED driver, or power supply unless the luminaire is identified as Type IC for insulation contact.

Luminaires that meet the air leakage requirement or luminaires that are Type IC rated will have this information listed on luminaire cut sheets or packaging. Installers are responsible for ensuring that luminaires are properly sealed to prevent air leakage between the luminaire housing and ceiling.

Recessed luminaires that are marked for use in fire-rated installations and recessed luminaires installed in non-insulated ceilings are exempt from the air leakage requirement and sealing requirement, however, they must meet all other requirements for recessed luminaires.

**Figure 6-2 Recessed Luminaire with an IC Housing (left); Recessed Luminaire with a Non-IC Housing (right)**



Source: Image Courtesy of Lutron Electronics Co., Inc.

#### **6.2.4 Enclosed Luminaires and Recessed Luminaires other than Ceiling-Recessed Downlight Luminaires**

For enclosed luminaires and recessed luminaires other than ceiling-recessed downlights, the installed light sources must be JA8-compliant and meet the elevated temperature testing requirement. The JA8-compliant lamps and light sources must be marked with “JA8-2022-E” to signify that they are suitable to be installed in an enclosed or recessed luminaire.

#### **6.2.5 Screw-Base Luminaires**

For screw-base luminaires to be installed in residential spaces, the installed lamps must be JA8 certified. Recessed downlight luminaires in ceilings cannot have screw base lamp sockets.

#### **6.2.6 Navigation Lighting – Night Lights, Step Lights and Path Lights**

Navigation lighting such as night lights, step lights, and path lights must either:

1. Be rated to consume no more than 4 watts; or
2. Comply with luminaire efficacy requirements in §150.0(k)1A and Table 150.0-A (Table 6-1).

#### **6.2.7 Lighting internal to Drawers, Cabinets, and Linen Closets**

Luminaires or light sources internal to drawers, cabinets, and linen closets must either:

1. Have an efficacy of 45 lumens per watt or greater or

2. Comply with luminaire efficacy requirements in §150.0(k)1A and Table 150.0-A (Table 6-4).

---

**Example 6-1: Screw-based luminaires****Question**

I am using a screw-based luminaire that is rated to take a 60W lamp for lighting over a sink, and I plan to install a 10W LED lamp. Does it meet the residential lighting requirement for screw-based luminaires?

**Answer**

If the LED lamp is JA8-certified and marked JA8-2022 or JA8-2022-E, then it meets the residential lighting requirement for screw-based luminaires in Energy Code §150.0(k)1B.

If the luminaire is a recessed luminaire in a ceiling, it would not comply since recessed luminaires cannot contain a screw base socket.

---

**Example 6-2: Color-tunable and dim-to-warm luminaires installed in residential buildings****Question**

Can color-tunable luminaires and dim-to-warm luminaires be certified to meet JA8 specifications?

**Answer**

JA8 includes color characteristic specifications for light sources.

The JA8 specifications require all light sources to be capable of providing color temperature (correlated color temperature, CCT) of 4000 Kelvin (K) or less.

JA8 also require light sources to provide color rendering index (CRI) of 90 or higher and R9 of 50 or higher. LED lamps regulated by the Title 20 Appliance Efficiency Regulations must have a CRI of 82 or higher.

If the color-tunable luminaire or dim-to-warm luminaire can provide a CCT of 4000k or less and provide CRI that meets these requirements, it meets the color characteristic criteria.

If all requirements of JA8 are met, including the color characteristic requirements, these light sources can be certified to meet JA8.

---

**Example 6-3: Fade-in lighting****Question**

I would like to use lighting with an aesthetic fade-in feature in my design. JA8 has a start time requirement. Are fade-in lights able to qualify as high efficacy?

**Answer**

Aesthetic fade-in lights are acceptable under Title 24. The test procedure for start time measures “[t]he time between the application of power to the device and the point where the light output reaches 98% of the lamp’s initial plateau.” The “initial plateau” is “[t]he point at which the average increase in the light output over time levels out (reduces in slope).”

For light sources with a fade-in feature, the light output intentionally follows a programmed fade-in curve to increase light output gradually. Because the light output must level out, the initial plateau for these light sources is the point in time at which there is perceived light output and the perceived light increase begins to follow the programmed fade-in curve. The programmed fade-in curve is expected to be continuously increasing as a function of time.

This allows fade-in lighting to qualify as high efficacy.

---

---

Example 6-4: Kitchen exhaust hood lighting

**Question**

I am installing an exhaust hood over my kitchen range that has lamps in it. Do these lamps have to be high efficacy?

**Answer**

This lighting is integrated into the appliance and does not have to meet the luminaire efficacy requirements for permanently installed lighting.

---

---

Example 6-5: Kitchen alterations

**Question**

I am designing a residential kitchen lighting system with six 12W LED recessed downlights and four 24W LED tape lights for under cabinet lighting. How many watts of incandescent or halogen luminaires can be installed?

**Answer**

There are no wattage limitations for residential lighting. However, all luminaires must meet the luminaire efficacy requirements in §150.0(k)1A and Table 150.0-A of the Energy Code. Incandescent and halogen light sources may not be able to meet the requirements of JA8, thus may not be able to be installed for Energy Code compliance.

---

---

Example 6-6: Night lights

**Question**

Where are night lights permitted to be installed in residential buildings?

**Answer**

There are no location restrictions in the Energy Code. Permanently installed night lights and night lights integral to installed luminaires can be installed anywhere in single family buildings, or other residential spaces.

---

**6.2.8 Blank Electrical Boxes**

The number of electrical boxes that are more than 5 feet above the finished floor and do not contain a luminaire or other device shall be no greater than the number of bedrooms. These electrical boxes must be served by a dimmer, vacancy sensor control, low voltage wiring, or fan speed control.

---

Example 6-7: Blank electrical boxes

**Question**

For a three-bedroom house, how many blank electrical boxes can be installed?

**Answer**

Up to three blank electrical boxes can be installed if the electrical boxes are served by a dimmer, vacancy sensor control, low voltage wiring or fan speed control. The number of electrical boxes can be less than or equal to the number of bedrooms in the dwelling.

This requirement applies to blank electrical boxes located more than 5 feet above the finished floor. It does not apply to blank electrical boxes mounted 5 feet or less above the finished floor.

---

**6.3 Indoor Lighting Control Requirements**

Lighting controls are an important part of the Energy Code because they can produce energy savings for the owners and users of the spaces. Lighting Control Requirements in Accordance with Room and Luminaire Types

All lighting controls must comply with the mandatory requirements of §110.9 (refer to Section 6.3.2 for details). Following are general control requirements that apply for the room type and for the luminaire type:

**A. Readily Accessible Manual Controls**

All permanently installed luminaires shall have readily accessible wall-mounted controls that permit the luminaires to be manually turned on and off. Per §100.1 Definitions, “readily accessible” means capable of being reached quickly for operation, repair, or inspection without requiring climbing or removing obstacles, or resorting to access equipment.

**B. Multiple Switches**

A lighting circuit can be controlled by more than one switch, such as by three-way or four-way switches. For a lighting circuit with multiple switches, where a dimmer or

vacancy sensor has been installed to comply with §150.0(k), the following requirements must be met:

1. No controls shall bypass the dimmer or vacancy sensor function.
2. The dimmer or vacancy sensor must comply with the applicable requirements of §110.9(b).

### **C. Energy Management Control Systems (EMCS) and Multiscene Programmable Controllers**

An EMCS or a multiscene programmable controller can be installed to meet the dimming, occupancy, and lighting control requirements in § 150.0(k)2 if it provides the functionality of the specified controls in accordance with §110.9, and the physical controls specified in §150.0(k)2A.

### **D. Exhaust Fan Integrated Lighting**

Integrated lighting in an exhaust fan must be controlled independently from the fan.

### **E. Lighting for Drawers and Cabinets**

Undercabinet lighting, undershelf lighting, and interior lighting of display cabinets shall be controlled separately from ceiling-installed lighting such that one can be turned on without turning on the other.

Drawers and cabinetry with internal lights and opaque fronts or doors must have controls that turn the lights off when the drawer or door is closed.

### **F. Independent Control of Switched Outlets**

Switched outlets shall be controlled separately from ceiling-installed lighting such that one can be turned on without turning on the other.

### **G. Ceiling Fan Lighting**

Ceiling fans with integrated light sources can be controlled with a remote control for ON, OFF, and dimming control. The remote control does not need to be wall mounted.

### **H. Spaces Required to Have Vacancy Sensors or Occupancy Sensors**

The following residential spaces are required to have at least one installed luminaire in the space be controlled by an occupancy or vacancy sensor providing automatic-off functionality:

1. Bathrooms
2. Garages
3. Laundry Rooms
4. Utility Rooms
5. Walk-in Closets

### **I. Luminaires Required to Have Dimming Controls**

Lighting in habitable spaces such as living rooms, dining rooms, kitchens, and bedrooms must have readily accessible wall-mounted dimming controls that allow the lighting to be manually adjusted up and down.



There are three exceptions:

1. Ceiling fans may provide control of integrated lighting via a remote control.
2. Luminaires connected to a circuit with controlled lighting power less than 20 watts or controlled by an occupancy or vacancy sensor providing automatic-off functionality.
3. Navigation lighting such as night lights, step lights, and path lights less than 5 watts; and lighting with automatic off controls that is internal to drawers and cabinetry with opaque fronts or doors.

Also, lighting integral to appliances including kitchen range hoods and exhaust fans is not required to be provided with dimming controls.

Forward phase cut dimmers controlling LED light sources in these spaces shall comply with NEMA SSL 7A. The combined use of a NEMA SSL 7A-compliant dimmer with LED luminaires ensures flicker-free operation when the luminaire is dimmed. Dimmer/light source compatibility information is included on dimmer cut sheets or dimmer product packaging.

---

Example 6-8: Using vacancy sensors and dimmers

### **Question**

Can I install vacancy sensors and dimmers in hallways and non-walk-in closets even though the Energy Code does not require it?

### **Answer**

Installing controls such as vacancy sensors and dimmers in hallways and closets is allowed.

A vacancy sensor automatically turns lighting off when a space is unoccupied. This can save energy compared to a manual on-off switch where the light may be left on while the space is unoccupied.

Using vacancy sensors is recommended for any application where they can provide additional energy savings for the homeowner or occupant.

A dimmer varies the intensity of the light to suit the occasion or the time of day. When less light is needed, the homeowner can reduce the light intensity with a dimmer to save energy.

---

### **6.3.1 Lighting Control Functionality**

All installed lighting control devices and systems must meet the functionality requirements in §110.9(b). In addition, all components of a lighting control system installed together shall meet all applicable requirements for the application for which they are installed as required in §150.0(k).

§110.9(b) includes requirements for specific lighting control features and functionality. Designers and installers should review features of their specified lighting control

products for meeting the requirements of §110.9(b) as part of the code compliance process.

### **A. Time-Switch Lighting Controls**

Time-switch lighting control products shall provide the functionality listed in §110.9(b)1 of the Energy Code.

### **B. Dimmers**

Dimmer products shall provide the functionality listed in §110.9(b)3 of the Energy Code. Forward phase cut dimmers used with LED lighting must comply with NEMA SSL 7A.

### **C. Occupant Sensing Controls**

Occupant sensing controls (including occupant sensors, partial-ON occupant sensors, partial-OFF occupant sensors, motion sensors, and vacancy sensors) shall provide the functionality listed in §110.9(b)4 and 110.9(b)6 of the Energy Code.

Occupant sensing controls must automatically reduce lighting or turn the lighting off within 20 minutes after the area has been vacated.

Occupant sensing control systems may consist of a combination of single- or multi-level occupant, motion, or vacancy sensor controls, if components installed for manual-on compliance don't allow occupants to change the functionality from manual-on to automatic-on.

### **D. Using Vacancy Sensors or Occupancy Sensors**

Occupancy sensors automatically turn lighting on when a space becomes occupied, and automatically turn lighting off within 20 minutes of the space being vacated.

Vacancy sensors, also known as manual-on/automatic-off occupant sensors, require occupants to turn lights on manually, and automatically turn lights off within 20 minutes of the space being vacated.

Occupancy and vacancy sensors are required to provide the ability to manually turn lighting on and off. The manual off feature provides the flexibility to control the lighting environment by turning off lights when they are not needed.

The Energy Code allows occupancy sensors or vacancy sensors to be installed to meet the automatic-off control requirements.

---

#### **Example 6-9: Bathroom vacancy sensors – manual off**

##### **Question**

For a bathroom with a vacancy sensor, the lighting turns off automatically once the space is vacated. Is it necessary to provide a manual-off control?

##### **Answer**

Vacancy and occupancy sensors must provide the option to turn the lights off manually.

If an occupant forgets to turn the lights off when a room is unoccupied, the vacancy or occupancy sensor must turn the lights off automatically within 20 minutes. The occupant must also have the ability to turn the lights off upon leaving the room.

This provides flexibility to control the lighting environment and achieve greater energy savings, as lights can be turned off when not needed.

Example 6-10: Use of automatic shut-off controls

### **Question**

What type of automatic shut-off control can be used in a bathroom, garage, laundry room, utility room, or walk-in closet?

### **Answer**

Occupant or vacancy sensing controls that provide automatic-off functionality must be installed to meet the residential lighting control requirements for bathrooms, garages, laundry rooms, utility rooms, and walk-in closets.

---

Example 6-11: Using an Energy Management Control System

### **Question**

Can an EMCS be used to control under-cabinet lighting?

### **Answer**

An EMCS can be used to control under-cabinet lighting provided that the under-cabinet lighting is switched separately from the ceiling lighting systems as specified in §150.0(k)2G.

---

## **6.4 Residential Outdoor Lighting Requirements**

All lighting permanently attached to the residence or to other buildings on the same lot are subject to the outdoor lighting requirements. This includes lighting for patios, entrances, balconies, and porches.

Lighting not permanently attached to a building on a single-family site, such as decorative landscape lighting, is not regulated by the residential lighting requirements. High luminous efficacy lighting and controls such as a time clock or photocontrol will save energy and ensure that lighting is not accidentally left on during daylight hours.

### **6.4.1 Outdoor Luminaires**

All lighting must be high luminous efficacy. Table 150.0-A lists all qualifying high luminous efficacy luminaires and light sources. Outdoor LED luminaires and LED light sources installed outdoors are automatically classified as high luminous efficacy and are not required to comply with JA8.

### 6.4.2 Outdoor Lighting Controls

All lighting must be controlled by a manual ON and OFF control switch and one of the following automatic control types:

1. Photocontrol and either a motion sensor or an automatic time switch control.
2. Astronomical time clock control.

Any override that keeps the above automatic controls on must return to automatic control operations within six hours.

### 6.4.3 Internally Illuminated Address Signs

Internally illuminated address signs shall consume no more than 5 watts of power, or shall comply with nonresidential sign lighting requirements in §140.8.

---

Example 6-12: Outdoor lighting: glare control

#### Question

Are there luminaire cutoff requirements for residential outdoor luminaires?

#### Answer

There are no luminaire cutoff requirements for residential outdoor lighting. Even though not required for most residential outdoor lighting, luminaires that limit uplight are usually more efficient at providing lighting in the required area, allowing a lower wattage luminaire to be used. Backlight, uplight, and glare requirements also reduce stray light and glare problems which can cause visual discomfort.

---

---

Example 6-13: Outdoor lighting: landscape lighting

#### Question

I would like to install low-voltage landscape lighting in my yard. Are these required to be controlled by a motion sensor and photocontrol?

#### Answer

No. The lighting requirements only apply to lighting that is attached to a building or structure. However, using photocontrols or astronomical time clock controls can save energy by ensuring that landscape lighting is not left on during daylight hours.

---

## 6.5 Residential Garages

Residential garages are treated as indoor spaces. (See Section 6.3.1.H for lighting control requirement for residential garages.)

Residential garages are required to meet either the residential or the nonresidential requirements, depending on the number of vehicles that can be stored in the garage. For residential garages with space for eight or more vehicles, the lighting must comply

with the applicable requirements for nonresidential garages in Sections 110.9, 130.0, 130.1, 130.4, 140.6, and 141.0.

---

## **6.6 Additions and Alterations**

Additions are considered newly constructed buildings. Because the residential lighting requirements are mandatory, lighting in residential additions must meet all applicable requirements of §150.0(k).

For residential alterations, any new or altered lighting systems must meet all applicable requirements of §150.0(k). Existing luminaires, controls, and lighting systems that are not altered may stay as is.

---

## **6.7 Compliance Documentation**

Compliance documents must be completed and submitted to the enforcement agency to demonstrate compliance with the residential lighting requirements.

All residential lighting requirements are mandatory. There are no tradeoffs between lighting and other building features. A lighting certificate of installation is required to document the project scope of work and certify that all applicable lighting requirements have been met.

### **6.7.1 Certificate of Installation (CF2R-LTG)**

The certificate of installation for lighting is the CF2R-LTG.

#### **A. Person Responsible to Submit the Certificate of Installation**

The individual responsible for constructing and installing the residential lighting project (Title 24 California Code of Regulations, Part 1, §10-103(a)3) must submit the certificate of installation. This individual must be eligible under Division 3 of the Business and Professions Code to accept responsibility for the installed lighting system. This individual must ensure the installed lighting system complies with the applicable lighting requirements before signing the certificate.

#### **B. Number of Certificates of Installation Required**

A residential lighting project may require more than one certificate to be submitted. If one qualified person accepts responsibility for the installation of an entire lighting project, one certificate is needed. If one qualified person installs the lighting controls and another installs the luminaires, each person will need to submit a separate certificate.

A certificate must be submitted to the responsible code enforcement agency for any residential lighting project that is regulated by the Energy Code, whether that project includes installation of a single luminaire or installation of lighting for an entire building.

The responsible person or contractor installing permanently installed lighting must complete and sign the certificate. The responsible person or installer verifies whether high luminous efficacy lighting and the required controls (i.e., vacancy sensors, dimmer switches) were installed.

## C. Registration

Registration is required for projects that require Home Energy Rating System (HERS) field verification (see Title 20 California Code of Regulations §1670 et seq.). When registration is required, the certificates must be submitted electronically to an approved HERS provider data registry for registration and retention.

Registration requirements are in Chapter 2 of the *2022 Residential Compliance Manual*. Lighting measures do not require HERS verification.

---

## 6.8 For Building Officials

This section provides guidance for enforcement agency personnel and those working on their behalf about what to look for on plans, what compliance documents to expect, and what to prioritize in inspections.

### 6.8.1 Plans

#### A. Confirm All Specified Luminaires Are High Luminous Efficacy

All permanently installed luminaires shown on the plans and/or specifications must be high efficacy (§150.0(k)1A). Luminaires meeting any of the following comply with §150.0(k)1A:

1. Luminaires automatically classified as high luminous efficacy.
2. Luminaires that must use JA8-certified light sources or lamps.
3. JA8-certified luminaires.

Outdoor LED luminaires, LED light sources installed outdoors, and some conventional light source types are automatically classified as high efficacy. Refer to Section 6.2 for details about high luminous efficacy luminaires and JA8-compliant luminaires. Compliant luminaire types are in Table 6-1.

Plans, lighting specifications, and/or notes should specify how luminaires will comply. JA8-certified light sources can be verified by searching for the product listing in the [Energy Commission's Modernized Appliance Efficiency Database System \(MAEDbS\)](http://www.energy.ca.gov/appliances/) at <http://www.energy.ca.gov/appliances/>. JA8-certified light sources listed in MAEDbS have been certified to the Energy Commission as meeting the high luminous efficacy requirements in JA8. The enforcing agency can also request MAEDbS product listings to be submitted with the permit application.

#### B. Confirm All Required Controls Are Specified

Plans and specifications should indicate vacancy or occupancy sensing controls with at least one luminaire in each of the following spaces:

1. Bathrooms
2. Laundry rooms
3. Garages
4. Utility rooms

5. Walk-in closets

Luminaires installed in habitable spaces such as living rooms, dining rooms, kitchens, and bedrooms must have readily accessible wall-mounted dimming controls. Forward phase cut dimmers controlling LED light sources must comply with NEMA SSL-7A.

Residential garages for eight or more vehicles must comply with nonresidential lighting requirements. Plans, specifications, and notes should describe any applicable nonresidential lighting requirements.

More information about indoor lighting control requirements is included in Section 6.3.

**C. Confirm Any Applicable Outdoor Lighting**

Outdoor lighting shall be shown on plans or described in specifications and/or notes to be high luminous efficacy and to meet the control requirements of §150.0(k)3.

**6.8.2 Compliance Documentation**

Confirm that all required compliance documentation is included with the plans.

**A. Certificate of Installation**

The certificate of installation (CF2R-LTG) is the primary compliance document for residential lighting. There will be one or more CF2R-LTG forms submitted for each project. Confirm all lighting systems and lighting controls in the project are covered by a CF2R-LTG. Confirm all CF2R-LTG forms are registered if the project requires HERS field verification and diagnostic testing. (HERS verification is not required for residential lighting, but registration is required if any project measures do require HERS verification.)

**B. Lighting Schedule**

Builders must submit a lighting schedule to homeowners or occupants at the time of occupancy. This schedule should describe all installed interior luminaires and lamps. A draft schedule should be included for the plan check. In addition to a list of installed lighting systems, provided documentation should include necessary system information for regular operations and maintenance.

---

**6.9 For Manufacturers – Certification to the Energy Commission**

The following are guidelines for manufacturers to ensure their lighting products meet residential lighting requirements of the Energy Standards:

Light source products (luminaires, lamps, and light sources) that are required to comply with Reference Joint Appendix JA8 shall be marked with JA8-2022 or JA8-2022-E.

For lighting control and light source products to be certified to the Energy Commission (as defined in §100.1), the manufacturer must comply with the requirements of certification. Certification can be done on the Energy Commission's Certifications Packets [webpage](https://www.energy.ca.gov/files/certification-packets-appliances) which is <https://www.energy.ca.gov/files/certification-packets-appliances>. The procedures include filling out a certification packet and submitting a

declaration of compliance, executed under penalty of perjury of the laws of California, that the regulated product meets the requirements.

Building departments, builders, installers, lighting designers, and specifiers are advised to use the MAEDBS database to verify that a regulated product has been certified to the Energy Commission by the manufacturer.

Luminaires do not need to be shipped with a JA8-certified lamp by manufacturers.

### 6.9.1 Luminaires, Lamps, and Other Light Sources Complying with JA8 and JA10

Joint Appendix JA8, “Qualification Requirements for High Luminous Efficacy Light Sources,” is a technical specification with requirements for luminaires, lamps, and light sources. JA8 specifies the performance requirements that light sources must meet, and the testing procedures that must be used to measure the performance metrics. Table 6-3 provides an overview of performance requirements.

The elevated temperature life test requirement is optional as stated in JA8.5, and is required only for light source products intended for installation in enclosed or recessed luminaires. Light sources that have passed the elevated temperature life test specified in the ENERGY STAR Product Specification for Lamps Version 2.1, or that have passed the rated life test specified in the ENERGY STAR Product Specification for Luminaires Version 2.1, can be marked with JA8-2022-E.

LED trim kit products like the one shown in Figure 6-3 do not need to be tested for elevated temperature or marked with JA8-2022-E; however, they are still required to comply with JA8 and be marked with JA-8-2022.

**Figure 6-6-3 An image of a LED Trim Kit**

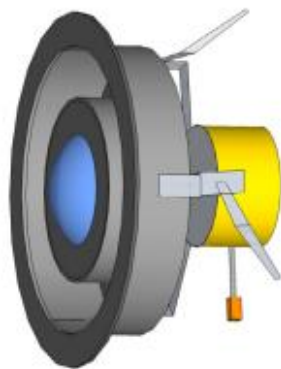

Source: California Energy Commission

Joint Appendix JA10, “Test Method for Measuring Flicker of Lighting Systems and Reporting Requirements,” is a supplement to the reduced flicker operation requirement of JA8. JA10 describes the test method to measure the flickering of light from the lighting system. The test involves using signal processing to remove high frequency components and quantifies flicker as a percent amplitude modulation below a given cut-off frequency.



**6.9.2 Marking Designation, and Product Data Required for JA8-Certified Luminaires, Lamps and Light Sources**

JA8-certified products, including luminaires, lamps, and light sources, must be marked as meeting the requirement of Section JA8.5.

Table 6-2 shows different marking designations depending on the light source type.

Table 6-3 shows the required data to be submitted to the Energy Commission for JA8 certification and for meeting JA8.6.

**Table 6-2: Summary of Marking Designation for Certified JA8 luminaires, Lamps and Light Sources**

Light Source Type	Marking Designation	Testing Notes for Meeting the Lumen Maintenance and Rated Life Requirements
1.Ceiling recessed downlight luminaires	JA8-2022	Optional for the rated life test of ENERGY STAR® Product Spec for Luminaires Version 2.2.
2.Lamps and light sources installed in enclosed or recessed luminaires	JA8-2022-E	Light sources must pass the elevated temperature life test of ENERGY STAR® Product Spec for Lamps Version 2.1; or the rated life test of ENERGY STAR® Product Spec for Luminaires Version 2.2 to be marked with “JA8-2022-E”.
3.Light sources other than #1 and #2.	JA8-2022	Optional for the rated life test of ENERGY STAR® Product Spec for Lamps Version 2.1 or Section 10 of ENERGY STAR® Product Spec for Luminaires Version 2.2.

**Table 6-3: Data to Be Submitted to the California Energy Commission to Meet JA8.6**

<b>METRIC</b>	<b>JA8 REQUIREMENTS</b>
Light source type	LED, OLED, Fluorescent, HID, Incandescent, Other
Product type	Omnidirectional lamp, Directional lamp, Decorative lamp, LED light engine, Inseparable SSL luminaire, T20 lamp, Other
Lab accredited by NVLAP or accreditation body operating in accordance with ISO/IEC 17011	Yes
Initial efficacy	≥ 45 lumens/W
Power factor at full rated power	≥ 0.90
Start time	≤ 0.5 sec
Correlated color temperature (CCT)	≤ 4000 K
Color rendering index (CRI)	≥ 90 for all products other than T20 lamps ≥ 82 for T20 lamps
Color rendering R9 (red)	≥ 50 for all products other than T20 lamps
Ambient or elevated temperature	Ambient or Elevated
Minimum dimming level	≤ 10%
Dimming control compatibility	At least one type must be listed
NEMA SSL 7A compatible?	If compatible with forward phase cut dimmer control, "Yes." If not, "NA."
FLICKER:	--
See JA10 Table 10-1 for flicker data requirements and permissible answers	< 30% for frequencies ≤ 200 Hz at 100% light output
See JA10 Table 10-1 for flicker data requirements and permissible answers	< 30% for frequencies ≤ 200 Hz at 20% light output
AUDIBLE NOISE:	--
100% light output: Audible noise	≤ 24 Dba
20% light output: Audible noise	≤ 24 Dba
MARKING:	--
Marked in accordance with JA8.5	Yes

## Table of Contents

7 Buildings	Photovoltaic, Community Shared Solar, Battery Storage, and Solar Ready 1	<b>1</b>
7.1	Overview .....	<b>1</b>
7.1.1	What’s new for 2022.....	1
7.2	Prescriptive Requirements for Photovoltaic System .....	<b>1</b>
7.2.1	Photovoltaic System Size.....	1
7.2.2	Exceptions to PV requirements.....	3
7.2.3	Joint Appendix 11 (JA11) Requirements.....	4
7.3	Performance Approach Compliance for Photovoltaic System .....	<b>7</b>
7.3.1	Energy Budget Calculation.....	7
7.3.2	Exceptions to PV requirements.....	7
7.3.3	Additional Requirements.....	8
7.4	Community Shared Solar Electric Generation and Storage Systems.....	<b>9</b>
7.4.1	Photovoltaic System Size.....	9
7.4.2	Enforcement Agency .....	10
7.4.3	Energy Performance and Minimum Community Shared PV and Battery Storage Size.....	10
7.4.4	Participating Building Energy Savings and Bill Reduction Benefits.....	11
7.4.5	Durability, Participation, and Building Opt-Out.....	11
7.4.6	Additionality .....	12
7.5	Battery Storage System .....	<b>15</b>
7.5.1	Minimum System Performance Requirements.....	16
7.5.2	Controls Requirements for Prescriptive and Performance Compliance Paths 16	16
7.5.3	Controls Strategies .....	17
7.6	Solar Ready Overview.....	<b>20</b>
7.6.1	Covered Occupancies.....	21
7.6.2	Solar Zone .....	21
7.6.3	Azimuth (Solar Zone) .....	25
7.6.4	Shading (Solar Zone) .....	26
7.6.5	Structural Design Loads (Solar Zone) .....	27

7.6.6	Interconnection Pathways.....	27
7.6.7	Documentation .....	27
7.6.8	Main Electrical Service Panel .....	28
7.7	California Fire Code Solar Access Requirements.....	<b>28</b>
7.8	Battery Ready Overview .....	<b>29</b>
7.9	Compliance and Enforcement.....	<b>29</b>

# 7 Photovoltaic, Community Shared Solar, Battery Storage, and Solar Ready Buildings

---

## 7.1 Overview

Chapter 7 describes the compliance requirements for photovoltaic (PV) systems, battery storage systems, and solar and battery ready for newly constructed single-family residential buildings. The prescriptive PV requirement sets the standard design budget for the performance compliance method. Installation of battery storage system is a compliance option, and this chapter describes the qualification requirement for this credit. The requirements for solar ready buildings are mandatory measures for newly constructed single-family residential buildings that do not have a PV system due to an exception in Section 150.1(c)14. The solar ready requirement is implemented when designing the building's rooftop and associated equipment. The intent is to reserve a penetration-free and shade-free portion of the roof for the potential future installation of a solar energy system. There are no requirements to install panels, conduit, piping, or mounting hardware.

For information about solar water heating system, please see Chapter 5.

### 7.1.1 What's new for 2022

#### 7.1.1.1 Mandatory Measures

1. Energy Storage System (ESS) ready is now required for all single-family buildings with one or two dwelling units. See section 7.8 for details.

#### 7.1.1.2 Prescriptive & Performance Compliance

1. Revised exceptions to the PV requirement for buildings with limited Solar Access Roof Area (SARA), enforcement-authority-approved roof designs in areas with high snow loads, designs approved by the local planning department prior to January 1, 2020 with mandatory conditions for approval, and some buildings with battery storage.
2. An additional control strategy was added to Joint Appendix JA12 for Separate Battery Storage Systems when battery systems are installed separate from on-site PV systems.

---

## 7.2 Prescriptive Requirements for Photovoltaic System

### 7.2.1 Photovoltaic System Size

§150.1(c)14
-------------

To comply with the prescriptive requirements, all single-family buildings are required to have a PV system installed unless the building qualifies for an exception. The minimum qualifying size of the PV system is based on the projected annual electrical usage as described by the Equation 7-1 below.

## Equation 7-1

$$\text{kW}_{\text{PV required}} = (\text{CFA} \times \text{A})/1000 + (\text{NDwell} \times \text{B})$$

WHERE:

$\text{kW}_{\text{PV}}$  =  $\text{kW}_{\text{dc}}$  size of the PV system

CFA = Conditioned floor area

NDwell = Number of dwelling units

A = Adjustment factor from Table 7-1

B = Dwelling adjustment factor from Table 7.1

Table 7-1 – CFA and Dwelling Adjustment Factors

Climate Zone	A - CFA	B - Dwelling Units
1	0.793	1.27
2	0.621	1.22
3	0.628	1.12
4	0.586	1.21
5	0.585	1.06
6	0.594	1.23
7	0.572	1.15
8	0.586	1.37
9	0.613	1.36
10	0.627	1.41
11	0.836	1.44
12	0.613	1.40
13	0.894	1.51
14	0.741	1.26
15	1.56	1.47
16	0.59	1.22

### 7.2.2 Exceptions to PV requirements

**Annual Solar Access:** The annual solar access is the ratio of solar insolation including shading to the solar insolation without shading. Refer to Exceptions for Reduced Solar Zone Due to Shade, in Section 7.6.2, for an example of how to calculate solar access.

**Effective Annual Solar Access:** The effective annual solar access shall be 70 percent or greater of the output of an unshaded PV array on an annual basis.

**Effective Annual Solar Access Roof Areas:** Are roof areas that meet the Effective Annual Solar Access requirements and are at least 80 contiguous square feet.

**Solar Access Roof Area (SARA):** The area of the building's roof, covered parking areas, carports, and all other newly constructed structures that are capable of structurally supporting a PV system per Title 24, Part 2, Section 1511.2. SARA does not include any roof area with less than 70 percent annual solar access.

There are five allowable exceptions to the prescriptive PV requirements as listed below.

Exception 1: may apply if there is limited unshaded roof space. For steep slope roofs, SARA shall not consider roof areas with a northerly azimuth that lies between 300 degrees and 90 degrees from true north. No PV system is required if the SARA is less than 80 contiguous square.

Exception 2: No PV system is required when the minimum PV system is less than 1.8 kWdc.

Exception 3: Buildings with enforcement-authority-approved roof designs, where the enforcement authority determines it isn't possible for the PV system, including panels, modules, components, supports, and attachments to the roof structure, to meet the snow load requirements of Ch. 7 in the American Society of Civil Engineers (ASCE) Standard 7-16.

Exception 4: For buildings that are approved by the local planning department prior to January 1, 2020 with mandatory conditions for approval:

1. Shading from roof designs and configurations for steep-sloped roofs, which are required by the mandatory conditions for approval, shall be considered for the annual solar access calculation.
2. Roof areas, that are not allowed by the mandatory conditions for approval to have PVs, shall not be considered in determining the SARA.

Exception 5: may apply to buildings with a battery storage system. PV system sizes determined using equation 150.1-C may be reduced by 25 percent if installed in conjunction with a battery storage system. The battery storage system shall meet the qualification requirements specified in Join Appendix JA12 and have a minimum usable capacity of 7.5 kWh.

### Example 7-1 Detached Building

#### Question:

Does a new detached building classified as occupancy U (like a pool house, rec room, art studio, etc.) on a residential lot need to meet the solar PV requirements in Energy Code Section 150.1?

#### Answer:

Yes. A conditioned, newly constructed building classified as U-building on a residential lot needs to meet the PV requirements in Section 150.1(c)14 of the Energy Code. Using the prescriptive method, the annual PV electrical output Equation 150.1-C allows for an input of zero for the number of dwelling units. Using the performance method, the PV calculation is automated to at least one dwelling unit.

### Example 7-2

#### Question:

#### Answer:

---

## 7.2.3 Joint Appendix 11 (JA11) Requirements

The installed PV system must meet the applicable requirements specified in JA11.

### 7.2.3.1 System Orientation

For prescriptive path compliance, a PV system with module pitches greater than 2:12, or 10 degrees, must be oriented between 90 to 300 degrees from true north. Module pitches less than 10 degrees (low-slope) can be installed in any orientation since azimuth of low-slope modules has an insignificant impact on array performance.

When using the performance approach, the array may be oriented in any direction, including due north; however, the more the orientation deviates from the optimum orientation of southwest, the worse the system performs, resulting in a larger PV system size needed to achieve compliance. It is best to orient the panels as close to southwest as possible to maximize the system performance with the smallest array size.

To use the California Flexible Installation 1 (CFI1) simplified modeling option in the performance method, the PV array must be installed between 150 to 270 degrees from true north, with all modules at the same tilt as the roof for pitches up to 7:12.

When the CFI2 option is selected in the performance calculation, the PV array must be installed between 105 and 300 degrees from true north, with all modules at the same tilt as the roof for pitches up to 7:12. Note, when selecting CFI2, the performance of the proposed system is derated by approximately 10 percent.

If the PV array does not meet either CFI1 or CFI2, then the actual orientation and tilt of the PV array shall be described.



**7.2.3.2** Shading

Shading from obstructions must be limited to meet the performance or prescriptive requirements. For prescriptive compliance, if the PV system does not qualify for Exception 1 described above, then the weighted average annual solar access by panel count shall be at least 98 percent. Any obstruction located north of the array does not need to be considered. Obstructions include the following:

- (a) Any vent, chimney, architectural feature, mechanical equipment, or other obstruction that is on the roof or any other part of the building.
- (b) Any part of the neighboring terrain.
- (c) Any tree that is mature at the time of installation of the PV system.
- (d) Any tree that is planted on the building lot or neighboring lots or planned to be planted as part of landscaping for the building. (The expected shading shall be based on the mature height of the tree.)
- (e) Any existing neighboring building or structure.
- (f) Any planned neighboring building or structure that is known to the applicant or building owner.
- (g) Any telephone or other utility pole that is closer than 30 feet from the nearest point of the array.

---

**Example 7-3** Shading

Question:

What would be the impact of shading on the PV sizing requirement?

Answer:

Prescriptively the PV array cannot have any shading and the weighted average annual solar access as measured by an approved solar assessment tool must be at least 98 percent by panel count. Under the performance path, there is no minimum requirement for annual solar access, however the increase in shading (lower annual solar access) will necessitate in a larger PV size to meet the same TDV budget as a smaller unshaded PV system.

---

**7.2.3.3** Solar Access Verification

A solar assessment tool that is approved by the Executive Director must be used to demonstrate the shading conditions of the PV system or when claiming an exception based on limited amount of solar access.

The installer must provide documentation that demonstrates the actual shading condition of the installed PV system using an approved solar assessment tool. To be certified by the Executive Director, the solar assessment tool:

- a. Must calculate the annual solar access percentage of each individual solar array and a weighted average of the PV system. The calculation must include all known obstructions, including any tree that is planted on the building lot or neighboring lots or planned to be planted as part of landscaping for the building.
- b. Must not include horizon shading in the calculation by default,
- c. Must produce a shade report with a summary of the PV system, including the address of the project, individual array panel count, orientation, annual solar access percentage, and a weighted average of the PV system as a whole.
- d. Annual solar access percentage values must be comparable to on-site measurements, if the tool's model shading condition is based on satellite or aerial images. Documentation must be provided to the CEC as proof.

#### **7.2.3.4 Remote Monitoring Capability**

The PV system must have a web portal and a mobile device application that enables the building owner, manager, or occupants to monitor the performance of their PV system to identify, report, and correct performance issues with the panels, inverters, shading, or other issues that may adversely impact the performance of the PV system. At a minimum, the occupants must have access to the following information:

- (a) The nominal kW rating the PV system.
- (b) Number of PV modules and the nominal watt rating of each module.
- (c) Hourly (or 15-minute interval), daily, monthly, and annual kWh production in numeric and graphic formats for the system.
- (d) Running total of daily kWh production.
- (e) Daily kW peak power production.
- (f) Current kW production of the entire PV system.

#### **7.2.3.5 Additional Requirements**

In addition to the requirements above, the PV system must also meet the following requirements in JA11:

**Interconnection Requirements:** All inverters in the PV system must comply with the CPUC Electric Tariff Rule 21, which governs CPUC-jurisdictional interconnections for all net energy metering (NEM) customers. Rule 21 requires that inverters have certain capabilities to ensure proper operation of the electrical grid as more renewables are interconnected. The inverters must perform functions that can autonomously contribute grid support during excursions from normal operating voltage and frequency system conditions by providing dynamic reactive/real power support, voltage and frequency ride-through, ramp rate controls, communication systems with ability to accept external commands, and other functions.

Certificates and Availability: The PV installer shall certify on the Certificate of Installation that all provisions of JA11 are met and provide a solar assessment report meeting one of the following conditions:

- (a) A satellite, drone, or other digital image used in the solar assessment report must be created and dated after the PV system is installed.
- (b) If the satellite, drone, or other digital image used in the solar assessment report is dated before the PV is installed, additional on-site pictures must be attached to clearly show that the installed system matches the system modeled in the solar assessment report

The Certificate of Installation shall be available on the building site for inspections.

Enforcement Agency Responsibilities: The local enforcement agency shall verify that the Certificate of Installation is valid complete and correct, and uploaded into a Commission-approved registry.

---

#### Example 7-4 Remote Monitoring

Question:

How do I implement monitoring to meet section JA11.5.1 including the current reading?

Answer:

There are multiple options. Many inverters can connect to the homeowner's internet, via ethernet and/or wireless. Others use independent cellular connections. For cellular, the data should be updated to the monitoring portal periodically as allowed by the cellular plan.

---

## 7.3 Performance Approach Compliance for Photovoltaic System

### 7.3.1 Energy Budget Calculation

The computer performance approach allows for the modeling of the PV system performance by considering PV system size, climate, panel orientations, inverter efficiency, and shading characteristics. The standard design PV system size is determined by the modeled annual electrical consumption of the mixed-fuel proposed design building, regardless of the actual fuel type of the proposed design building. The performance method allows for modeling different PV sizes, solar thermal systems, more energy efficiency measures, battery storage system and other demand response measures.

### 7.3.2 Exceptions to PV requirements

The five allowable exceptions to the prescriptive PV requirements listed in 7.2.2. can also be used under the performance approach. User must select the appropriate exception in the software and provide documentation to the building department with the building permit application.

### 7.3.3 Additional Requirements

The installed PV system must meet the applicable requirements as specified in JA11.

---

#### Example 7-5 Efficiency Tradeoff

Question:

Does the performance path allow tradeoffs between PV systems and energy efficiency measures? How about tradeoffs between a PV system that is coupled with a battery storage system and energy efficiency measures? How about a standalone battery storage system?

Answer:

Beginning with the 2019 Standards, the performance path no longer allows installing a larger PV system in exchange for less energy efficiency measures; however, the software will allow installing more energy efficiency, demand responsive measures, battery and storage and thermal storage systems in exchange for a smaller PV system.

When the PV system is coupled with at least a 5 kWh battery storage system, the performance path will allow a portion of the available credit to be used for efficiency measure tradeoffs; this is a modest credit that can be used to achieve compliance in buildings that have marginal difficulty achieving compliance.

The Standards allow standalone battery storage systems that are not coupled with a PV system; however, they are only allowed for buildings that do not have an onsite PV system due to an exception or being part of a CEC approved community solar program

---

---

#### Example 7-6 Solar Thermal System

Question:

Does a solar thermal water heating system still qualify for compliance credit in the performance path?

Answer:

Yes, although a solar water heating system cannot serve as a substitution for the prescriptively required PV system, it can still be installed along with PV for optional compliance credit in the performance path. Solar water heating systems are modeled along with the remainder of the water heating and distribution systems as part of the efficiency EDR score, and can be used for efficiency measures tradeoff, or installing a

smaller PV system. The requirements for solar thermal water heating systems are described in Chapter 5, Water Heating Requirements.

#### Example 7-7 Precooling

Question:

Can you explain precooling strategy requirements and how to comply with them?

Answer:

Precooling is a strategy that allows cooling the house by two or three degrees below the setpoint in the hours preceding the onset of peak time-of-use (TOU) hours, when the electricity rates are relatively low, and then turning off the air conditioning during the TOU peak hours, resulting in significant cost savings for the building occupants.

To obtain this credit, a JA5 compliant communicating thermostat must be installed in the dwelling unit and indicated on both CF1R and CF2R forms.

The precooling credit may only be used to lower the EDR score towards a more stringent EDR goal set by a reach code such as a local ordinance; this credit cannot be used to tradeoff the energy efficiency features of the building.

Finally, if the dwelling unit is already equipped with a battery storage system coupled with a PV system, the precooling strategy may have negligible impact on further lowering the EDR score.

---

## 7.4 Community Shared Solar Electric Generation and Storage Systems

### 7.4.1 Photovoltaic System Size

**§150.1(c)14**

The 2019 Building Energy Efficiency Standards allow the possibility for the Standards requirements for photovoltaics on the site of the residential building to be fully or partially offset by Community Shared Solar Electric Generation. Community Shared Solar Electric Generation means solar electric generation or other renewable technology electric generation that is installed at a different site. Also, the batteries that can be installed in combination with photovoltaics on the building site to gain performance standards compliance credit can be fully or partially offset by Community Shared Battery Storage Systems that are installed at a different site. Community Shared Solar Electric Generation Systems and Community Shared Battery Storage Systems could be installed in combination or separately. Such systems are hereinafter referred to just as Community Shared Solar Generation Systems.

For these offsets to become available, entities who wish to serve as administrators of a proposed Community Shared Solar Electric Generation System must apply to the Energy Commission for approval, demonstrating that several criteria specified in Section 10-115 of the Standards are met, to ensure that the Community Shared Solar Generation System

provides equivalent benefits to the residential building expected to occur if photovoltaics or batteries had been installed on the building site. The Energy Commission will carefully consider these applications to determine if they meet these criteria. If approved, Energy Commission approved compliance software will be modified to enable users to take compliance credit for buildings served by that Energy Commission approved Community Shared Solar Electric Generation System.

Any entity may apply to serve as administrator of a proposed Community Shared Solar Electric Generation System, including but not limited to utilities, builders, solar companies, or local governments. The entity will be responsible for ensuring that the criteria for approval are met throughout (at least) a twenty-year period for each building that uses shares of the Community Shared Solar Electric Generation System for partial or full offset of the onsite solar electric generation and batteries, which would otherwise be required for the building to comply with the Standards. Throughout that period the administrator will be accountable to builders, building owners, enforcement agencies, the Energy Commission, and other parties who relied on these systems for offset of full or partial compliance with the Standards. Records demonstrating compliance with the criteria must be maintained over that period, with access to those records provided to any entity approved by the Energy Commission.

Entities interested in applying to serve as administrator of a proposed Community Shared Solar Electric Generation System should become thoroughly familiar with the criteria for approval specified in Section 10-115 and contact the Energy Commission Building Standards Office for further discussion and explanation of the criteria as necessary.

In general, the Community Shared Solar Electric Generation System must meet the following:

#### 7.4.2 Enforcement Agency

The Community Shared Solar Electric Generation System must exist and be available for enforcement agency review early in the permitting process, and shall not cause delay in the enforcement agency review and approval of the building that will be served by the Community Shared Solar Generation System. All documentation required to demonstrate compliance for the building and the compliance offset from the Community Shared Solar Electric Generation System shall be completed and submitted to the enforcement agency with the permit application. The enforcement agency must be provided facilitated access to the Community Shared Solar Generation System to verify the validity and accuracy of compliance documentation.

#### 7.4.3 Energy Performance and Minimum Community Shared PV and Battery Storage Size

Energy Commission approved compliance software must be used to show that the energy performance of the building's share of the Community Shared Solar Electric Generation System is equal to or greater than the partial or full offset claimed for the solar electric generation and batteries, which would otherwise be required for the building to comply with the Standards.

The minimum community shared solar size dedicated to the building and the annual kWh equivalence may be measured in one of two ways: (1) Using the CBECC-Res Simplified approach for PVs and the CFI orientation option, or (2) by modeling the actual attributes of the system using the detailed approach. When the detailed approach is used, the compliance software will determine a minimum kW size that will represent the portion of the community solar resource dedicated to the building, based on PV system component performance characteristics, azimuth (orientation and tilt), inverter type, tracking versus fixed systems, climate zone and CEC weather files containing solar availability data.

#### 7.4.4 Participating Building Energy Savings and Bill Reduction Benefits

A specific share of the Community Shared Solar Generation System, determined to comply with the Energy Performance requirement above, must be dedicated on an ongoing basis to the building. The energy savings benefits dedicated to the building shall be provided in one of the following ways:

1. Actual reductions in the energy consumption of the building
2. Utility energy reduction credits that will result in virtual reductions in the building's energy consumption, including but not limited to generation credit, solar charge, program charge, and power charge indifference adjustment (PCIA) charge
3. Payments to the building that will have an equivalent effect as energy bill reductions that would result from one of the other two options above

For all three options mentioned above, the reduction in energy bills resulting from the share of the Community Shared Solar Generation System dedicated to the building shall be greater than the cost that is charged to the building to obtain that share of the Community Shared Solar Generation System.

#### 7.4.5 Durability, Participation, and Building Opt-Out

1. Durability. The benefits from the specific share of the Community Shared Solar Generation System must be provided to each dedicated building for a period not less than 20 years.
2. Participation. Buildings using community shared solar and/or battery storage systems to comply with Sections 140.0(c), 150.1(a)3, or 170.0(a)3, must participate for at least 20 years, regardless of who owns or occupies the building, unless the building owner fulfills the Opt-Out Requirements. The Energy Commission approved Administrator(s) shall require either of the following from the building owner as demonstration of participation compliance:
  - a. Equitable Servitude. A recorded covenant, or other legally binding method that runs with the land shall obligate the owner/tenant to maintain the building's participation in the community shared solar and/or community shared battery storage system for the Participation Period or satisfy the Opt-Out Requirements.

- b. Other system. Confirmation from another Energy Commission approved program or system used by the Administrator to ensure a participation period of at least 20 years, per Section 10-115(a)4B.
3. Compliance Documentation. The Administrator shall maintain record(s) of the compliance documentation that determined the requirements for the on-site solar electric generation system and/or battery storage system to comply with the standards in effect at the time the builder applied for the original building permit, and which establishes participants' obligations to meet the Opt-Out Requirements. The Administrator shall provide a copy of this compliance documentation upon a participating building owner's request to every new owner of a participating building when the Administrator is notified that the title has transferred, and to any participating building owner who requests to opt-out.
4. Building Opt-Out. During the Participation period, the participating building owner has the option to Opt-Out if the Opt-Out Requirements are met.
  - a. Prior to Opt-Out, the building owner shall demonstrate that they have installed an on-site solar electric generation system and met the Opt-Out Requirements by providing documentation from the installer of the on-site solar system or an attestation of the building owner with supporting documentation. The building owner is responsible for all costs associated with documentation for Opt-Out requirements.
  - b. The Administrator shall review Opt-Out documentation and determine if the installed solar system meets the Opt-Out requirements. Within 30 days the Administrator shall provide written confirmation whether the building meets the Opt-Out requirements.
  - c. All costs and benefits associated with participation in the program shall cease and all outstanding balance shall be paid to that party.
  - d. The Administrator (or other entity) shall not impose any penalty related to a participating building's Opt-Out, or charge participants for recuperation of unrealized revenue that would have been expected to accrue beyond the end of participation. If the Administrator plans to change any other fees at the time of building Opt-Out, the Application for commission Approval shall explain the purpose of those fees.

#### 7.4.6 Additionality

The specific share of the Community Shared Solar Generation System must provide the benefits to the participating building that are in no way made available or attributed to any other building or purpose. Renewable Energy Credits that are unbundled from the Community Shared Solar Electric Generation System do not meet this additionality requirement.

1. The participating building(s) shall be served primarily by renewable resources developed specifically for the community solar electric generation system.



2. Other renewable resources meeting the requirements of Section 10-115(a)4 may be used for each participating building if the building(s) is permitted before the renewable resources developed for the program start operating, or after they cease operating.
3. For each renewable resource developed to serve participating buildings, bundled Renewable Energy Credits (RECs), which satisfy the criteria of Portfolio Content Category 1, shall be retired and tracked in the Western Renewable Energy Generation Information System (WREGIS) on behalf of program participants to ensure they will not be allocated to or used for any other mandatory or voluntary renewable electricity program requirement or claim.
4. Excess generation from renewable resources may be used to serve other loads but must be isolated from the generation serving participating buildings. This is not considered a violation of Section 10-115(a)5C, the Additionality requirement above.

---

#### Example 7-8

##### Question:

To help entities that might want to apply to the Energy Commission for approval of a Community Shared Solar Energy Generation System, please provide examples of each of the three optional ways energy savings benefits could be provided to comply with Section 7.4.4.

##### Answer:

Examples would include:

Actual reductions in the energy consumption of the building: This could be accomplished by locating the PV systems for several houses on a carport on common land in a subdivision, and direct wiring the unique PV panels serving each house to an inverter that is located on the home's site. For homes served by utilities that are subject to compliance with Net Energy Metering requirements, the common land that is hosting the PVs on the carport would have to be adjacent to (could be directly across a street) the houses that are being served by the PV system. All other requirements of Section 10-115 would have to be met.

Utility energy reduction credits that will result in virtual reductions in the building's energy consumption that is subject to energy bill payments: This could be accomplished for qualifying multi-family dwellings by participation in an approved virtual net metering program, which has PVs installed on the multi-family project site, and energy bill credits that reduce each dwelling unit's monthly electricity bill consistent with Net Energy Metering requirements. Alternatively, this could be accomplished through a community shared solar program administered by a utility (like the Green Tariff Shared Renewables, or GTSR), for which a remote renewable resource is paid for through shares purchased for each home. In exchange, energy bill credits that reduce monthly electricity bills are allocated based on the homes' shares, including but not limited to generation credit, solar

charges, program charges, and nonparticipant charges. All other requirements of Section 10-115 would have to be met.

Payments to the building that will have an equivalent effect as energy bill reductions that would result from one of the two options above: This could be accomplished by builders installing PV systems on other properties they own to offset the compliance requirement for onsite PVs on homes they build. The homes would pay for a share of the PV systems on the other properties. The builders would be obligated to make an ongoing cash payment back to the homes for the home's share of the electricity generation achieved by the PV systems on the other properties. The share of the ownership of the PV systems on the other properties and the corresponding sharing of the electricity generation achieved by the PV systems on the other properties would not be accounted for through a utility system – the ownership share would not be paid to the utility and the payment for the share of the electricity generation achieved by the PV systems on the other properties would not be provided through a utility bill. The entire program would be administered by the builder for a 20-year period for each home. All other requirements of Section 10-115 would have to be met.

---

---

#### Example 7-9

##### Question

Could you also explain what the cost requirements are in the last sentence of Section 7.4.4.

##### Answer

Regardless of the three options chosen above, it must be cost effective for the home to participate in a community shared solar electric generation system program. The participating home will pay for its share of the community renewable resource and will receive either energy bill reductions, credits, or cash payments for the electricity that is generated by the community renewable resource. The value of the reductions, credits, or cash payments to the participating home must exceed its share value of the community renewable resource.

Let's take a hypothetical example of a Green Tariff Shared Renewables Program (GTSR) that is required by statute to be operated by investor-owned utilities. The following table shows the costs that the program charges a home to obtain shares of the program's

community solar resources, and the energy bill credit. The charges and credit are allocated per kWh generated by the home's share of the community renewable resource.

Example Green Tariff Shared Renewables Program Details	
Solar Charge	6.48 cents per kWh
Program Charge	2.956 cents per kWh
Power Charge Indifference Adjustment (PCIA) Charge	3.346 cents per kWh
Total Program Charges	12.782 cents per kWh
Generation Credit	-10.78 cents per kWh

The total cost that the home pays per kWh for its share of the community renewable resource is 12.8 cents per kWh and the energy bill credits for generation from the home's share of the community renewable resource is 10.8 cents per kWh. Since the value of the home's energy bill credit does not exceed the cost for the home to participate in the community solar program, the cost requirement of Section 7.4.4 is not met. Cost requirements can be brought into compliance through a combination of an increase in the generation credit and reductions in solar charge, program charge, and power charge indifference adjustment (PCIA) charge. In this example, if the generation credit raises by one cent, up to 11.8 cents, and total charges decrease by 1.1 cents, down to 11.7 cents, then the program meets the cost requirements.

---

## 7.5 Battery Storage System

The primary function of the battery storage system is to grid harmonize the onsite PV system with the grid, to bring maximum benefits to the grid, environment, and the occupants.

**Grid Harmonization:** For the purpose of Building Standards, grid harmonization is defined as strategies and measures that harmonize customer owned distributed energy resources assets with the grid to maximize self-utilization of PV array output, and limit grid exports to periods beneficial to the grid and the ratepayer. This is done by charging the battery from the PV system when there is limited electrical load at the building and the cost of electricity is low in midday, and discharging when the cost of electricity is high, usually in the late afternoon and early evening hours.

Battery storage system is available as a compliance credit in the performance compliance method, either coupled with an on-site PV system or as a standalone system if the building does not have on-site PV due to an exception or being part of a CEC approved community solar program. Battery storage is also a criterion of Exception 5 of the prescriptive PV requirements in section 150.1(c). In all cases, the battery storage system must meet all applicable requirements in Joint Appendix JA12 and be self-certified to CEC by the manufacturer as a qualified product.

A PV size can be specified with the performance approach based on a user-defined target energy design rating (EDR) and a coupled battery storage system with an appropriate battery control strategy. This is a cost-effective strategy for meeting lower target EDRs,

that may be required by reach codes, with a smaller, grid harmonized PV system. Various battery control strategies are described in Section 7.5.3 below.

The list of qualified JA12 products can be found here:

<https://solarequipment.energy.ca.gov/Home/Index>

### 7.5.1 Minimum System Performance Requirements

JA12 specifies that the battery storage system must meet or exceed the following specifications for both the prescriptive and performance approaches:

1. Usable capacity of at least 5 kWh
2. Energy capacity retention of 70 percent of nameplate capacity after 4,000 cycles covered by a warranty, or 70 percent of nameplate capacity under a 10-year warranty

In addition, if using the prescriptive approach, the single AC-to-AC charge-discharge cycle (round-trip) efficiency of the battery storage system must be at least 80 percent.

### 7.5.2 Controls Requirements for Prescriptive and Performance Compliance Paths

Battery storage systems that remain in backup mode indefinitely bring no grid benefits. The JA12 requirements are designed to ensure that the battery storage system remains in an active control mode and prevent the battery storage system from remaining in the backup mode indefinitely. These requirements also enable the battery storage system to receive the latest firmware, software, control strategy, and other important updates.

The following requirements apply to all control strategies, including Basic Control, Time-of-Use (TOU) Control, and Advanced Demand Flexibility Control, described in Section 7.5.3 below:

1. The battery storage system shall have the capability of being remotely programmed to change the charge and discharge periods.
2. During discharge, the battery storage system shall be programmed to first meet the electrical load of the dwelling unit(s). If during the discharge period the electrical load of the dwelling unit(s) is less than the maximum discharge rate, the battery storage system shall have the capability to discharge electricity into the grid upon receipt of a demand flexibility signal from the local utility or a third-party aggregator.
3. The battery storage system shall operate in one of the control strategies listed in Section 7.5.3 except during a power interruption, when it may switch to backup mode. If the battery system switches to backup power mode during a power interruption, upon restoration of power the battery system shall immediately revert to the previously programmed JA12 control strategy. The device must have the feature that would enable export to be built in at the time of installation. It can be in the off mode and be turned on later with a remote signal.

4. The battery storage system shall perform a system check on the following dates, to ensure the battery is operating in one of the control strategies listed section 7.5.3 below:
  - a. Within 10 calendar days before the onset of summer TOU schedule, and
  - b. Within 10 calendar days before the onset of winter TOU schedule

If the local utility does not offer TOU rate schedule, the default system check dates should be 1 May and 1 November. At the time of inspection, the battery storage system shall be installed to meet one of the following control strategies. The battery storage system also shall have the capability to remotely switch to the other control strategies.

### 7.5.3 Controls Strategies

JA12 includes four control strategies that are designed to encourage charging the batteries when electricity prices are low, generally in the middle of the day when solar resources are plentiful and demand is low, and discharge the batteries later in the day when demand is high and solar resources are diminished:

**Basic Control:** Designed as a simple control that can be employed as the default control in the absence of TOU or Advanced Demand Flexibility Controls, or where communication between batteries and outside parties are not possible. When combined with an on-site solar PV system, to qualify for the Basic Control, the battery storage system shall be installed in the default operation mode to allow charging only from an on-site PV system when the PV system production is greater than the on-site electrical load. The battery storage system shall discharge only when the PV system production is less than the on-site electrical load.

**Time-of-Use (TOU) Control:** Designed to take advantage of TOU rates where they are available. This control strategy generally results in a greater Energy Design Rating (EDR) impact than the Basic Control. When combined with an on-site PV system, to qualify for the TOU Control, the battery storage system shall be installed in the default operation mode to allow charging only from an on-site PV system. The battery storage system shall discharge during the highest priced TOU hours of the day. The operation schedule shall be preprogrammed from factory, updated remotely, or programmed during the installation/commissioning of the system. At a minimum, the system shall be capable of programming three separate seasonal TOU schedules, such as spring, summer, and winter.

**Advanced Demand Flexibility Control:** Designed to bring the maximum value to the PV system generations by placing the charge/discharge functions of the battery storage system under the control of a utility or a third-party aggregator. This control strategy allows discharging into the grid upon receiving a demand response signal from a grid operator. This option requires robust communication capabilities between the battery storage system and the local utility or the third-party aggregator. When combined with an on-site solar PV system, to qualify for the Advanced Demand Flexibility Control, the battery storage system shall be programmed by default as Basic Control or TOU control

as described above. The battery storage control shall meet the demand flexibility control requirements specified in Section 110.12(a). Additionally, the battery storage system shall have the capability to change the charging and discharging periods in response to signals from the local utility or a third-party aggregator

**Controls for Separate Battery Storage Systems:** When installed separate from (not in combination with) an on-site solar photovoltaic system, including when the building is served by a community solar PV system, to qualify for the compliance credit, the battery storage system shall be programmed by default to:

1. Start Charging from the grid at the onset of lowest priced TOU hours of the day and start discharging at the onset of highest priced TOU hours of the day, or
2. Meet all the demand flexibility control requirements specified in Section 110.12(a) and shall have the capability to change the charging and discharging periods in response to signals from the local utility or a third-party aggregator.

**Alternative Control Approved by the Executive Director:** The Commission recognizes that there may be other control strategies that bring equal or greater benefits than the ones listed above, therefore, the Executive Director may approve alternative control strategies that demonstrate equal or greater benefits to those strategies listed in JA12. To qualify for Alternative Control, the battery storage system shall be operated in a manner that increases self-utilization of the PV array output, responds to utility rates, responds to demand response signals, minimizes greenhouse gas emissions from buildings, and/or implements other strategies that achieve equal or greater benefits than those specified in JA12.2.3. This alternative control option shall be accompanied with clear and easy to implement algorithms for incorporation into the compliance software for compliance credit calculations.

#### Other Requirements

In addition to the requirements above, the battery storage system must also meet the following requirements in JA12:

**Safety Requirements:** The battery storage system shall be tested in accordance with the applicable requirements given in UL 1973 and UL 9540. Inverters used with battery storage systems shall be tested in accordance with the applicable requirements in UL 1741 and UL 1741 Supplement A.

**Interconnection and Net Energy Metering Requirements:** The battery storage system and the associated components, including inverters, shall comply with all applicable requirements specified in Rule 21 and Net Energy Metering (NEM) rules as adopted by the California Public Utilities Commission (CPUC).

**Enforcement Agency:** The local enforcement agency shall verify that all Certificate of Installations are valid. The battery storage systems shall be verified as a model certified to the Energy Commission as qualified for credit as a battery storage system. In addition, the enforcement agency shall verify that the battery storage system is programmed and operational with one of the controls listed in Section 7.5.3 above. The programmed

control strategy at system final inspection and commissioning shall be the strategy that was used in the Certificate of Compliance.

---

#### Example 7-10 Battery Storage Credit

Question:

Can you explain the battery storage credit requirements and how to comply with them?

Answer:

The performance path allows a compliance credit for: a battery storage system with a capacity of at least 5 kWh, programmed for basic, time-of-use, or advanced demand flexibility control, and is coupled with a PV system; a standalone battery storage system separate from an on-site PV system with control requirements meeting JA12.2.3.4. The PV/storage credit may be used to lower the total EDR score towards a more stringent EDR goal set by a reach code such as a local ordinance. However, the software will only allow a portion of the available credit to be used for efficiency measures tradeoff. This is a modest credit that can be used to achieve compliance in buildings that are marginally out of compliance.

The manufacturers must self-certify to the Commission that the battery storage systems meet the requirements of JA12. These include minimum performance requirements, communication requirements, control requirements, safety requirements, and interconnection requirements, among others, that must be complied with and certified to the Commission. The self-certification form may be downloaded from the Commission's website:

#### Example 7-11 Battery Storage Credit

Question:

When batteries are used there is a loss of energy associated with round trip charging and discharging, resulting in fewer generated kWh. Why does the Commission provide a compliance credit for a battery storage system that is coupled with a PV system if there is a loss of energy?

Answer:

Battery storage systems store the PV generated power in the middle of the day when the solar resources are generally plentiful and electricity prices are low. The systems discharge the stored power later in the day, during the peak hours when solar resources are diminished, and electricity prices are high. Battery storage systems have a charge-discharge (round trip efficiency) loss of 5 to 15 percent, depending on the type of battery and the inverter efficiencies. A compliance credit is available because the electricity price differential between the mid-day rate and the peak-hours rate is greater than the battery charge-discharge losses. This means that even with the relatively small loss of energy, it

is still cost effective for a consumer to store power generated on-site around mid-day and use it later on, instead of purchasing additional electricity from the grid.

To calculate the compliance credit of a battery storage system coupled with a PV system, the Energy Commission's compliance software, on an hourly basis, accounts for the PV generation, losses, storage capacity remaining, charge and discharge rates, cost of electricity, house loads, and hourly exports. Similar calculations are also performed to calculate the benefits of storage for CO2 emissions.

Only battery storage systems complying with JA12 requirements are eligible for compliance credit. The requirements ensure the battery storage system remains in a dynamic mode allowing residents to take advantage of variable electricity costs associated with charge and discharge periods throughout the day. Static batteries that remain mostly in backup mode have little to no value to the homeowner, the grid, or the environment.

#### Example 7-12 Battery Storage TOU schedule

Question:

How will control requirement be enforced for customers that are not on a TOU schedule? How about customers on TOU rate but want to be in Basic Control?

Answer:

If the local utility does not have a TOU schedule, to comply with JA12.2.3, the battery storage system should perform a system check on 1 May and 1 November by default. A customer can set the control strategy to Basic Control, regardless of whether a TOU rate is available for the customer. However, this strategy will reduce the benefits of the battery storage for both the customer and the grid, and therefore is not recommended.

---

## 7.6 Solar Ready Overview

The solar-ready provisions are mandatory for single-family residential buildings that do not have a solar PV system, most commonly due to an exception to the prescriptive PV requirements in Section 150.1(c)14. There are also exceptions to the "solar zone" requirements. These are described in the corresponding sections of this chapter. These exceptions remove the need to reserve a portion of the roof area as a solar zone. However, the requirements relating to the main electrical service panel, reserved areas for inverters, metering equipment, and interconnection pathways to the electrical service will still apply. For this reason, CF2R-SRA-01-E compliance forms must be submitted with the building permit application, even when using an allowable solar zone exception.

Please note: In §110.10 of the *Energy Standards*, the solar zone, interconnection pathways, and design load requirements for low-rise multifamily buildings are located with the high-rise multifamily requirements in §110.10(b)1B. Refer to the multi-family buildings chapter in the "Nonresidential Compliance Manual" for more information.



## 7.6.1 Covered Occupancies

### *§110.10(a)*

The solar-ready requirements apply to newly constructed single-family homes without a PV system located in a subdivision with 10 or more residences and where the tentative subdivision map application is complete and approved by the enforcement agency.

Note, even if homes within a subdivision of 10 or more residences use an approved community solar option for compliance, they must still meet the solar-ready requirements of Section 110.10, unless they qualify for an exception.

## 7.6.2 Solar Zone

### *§110.10(b)*

The solar zone is a suitable place where solar panels can be installed at a future date - if the owner chooses to do so. A solar zone area is designed with no penetrations, obstructions, or significant shade. The solar zone must comply with the access, pathway, smoke ventilation, and spacing requirements in Title 24 Part 9. Requirements from the other parts of Title 24, and those adopted by a local jurisdiction, should also be incorporated in the solar zone design.

### **7.6.2.1** Solar Zone Minimum Area

#### *§110.10(b)1*

The total area of the solar zone may be composed of multiple subareas - if they meet minimum size specifications. No dimension of a subarea can be less than five feet. If the total roof area is equal to or less than 10,000 square feet, each subarea must be at least 80 square feet. If the total roof area is greater than 10,000 square feet, each subarea must be at least 160 square feet.

### **7.6.2.2** Solar Zone Area for Single-Family Residential Buildings

The solar zone must be located on the roof or overhang of the building. The "designated" solar zone's total area must be no less than 250 square feet (§110.10(b)1A). See Figure 7-6 for some acceptable solar zone placement techniques.

There are six allowable exceptions to the required solar zone area. Exceptions 1 and 6 allow alternate efficiency measures instead of an actual solar zone, so the requirements for zone shading, azimuth, design load, interconnection pathways, owner documentation, and electric service panel do not apply.

Submit a CF2R-SRA-01-E to the building department for all projects that do not include a solar PV system, even when using an exception to solar zone requirements. In addition, submit a CF2R-SRA-02-E solar zone worksheet for all projects with a solar zone, including exceptions that allow a reduced solar zone area.

**7.6.2.3** Solar Zone Exceptions for Single-family Buildings:

Exception 1 may apply when a domestic solar water-heating (SWH) system is permanently installed at the time of construction. The SWH system must comply with the installation criteria in the Reference Residential Appendix RA4 and have a minimum solar savings fraction of 0.50. Note: These buildings are also exempt from the interconnection pathway, documentation, and electrical panel requirements because there is no solar zone.

Exception 2 may apply if the single-family home has three or more habitable stories and a total floor area  $\leq 2,000$  square feet. The designated solar zone may be reduced. The area must be  $\geq 150$  square feet.

Exception 3 may apply if the single-family home is in the Wildland-Urban Interface Fire Area (as defined in Title 24, Part 2). The solar zone area may be reduced to  $\geq 150$  square feet. In addition, a whole-house fan must be permanently installed at the time of construction. This exception is intended to accommodate attic- and roof-venting requirements in these fire areas.

Exception 4 reduces the solar zone area when the roof is shaded by objects that are not part of the building project, and therefore beyond the designer's control. The designated solar zone may be reduced to  $\geq 50$  percent of the potential solar zone area when solar access is limited as described below. When the "potential" solar zone is smaller than the 250 square feet minimum, the solar zone can be reduced to half the area of the potential solar zone. The reduced-size solar zone is called the "designated" solar zone.

Figure 7-2: Calculating Designated Solar Zone

### Exceptions for Reduced Solar Zone Due to Shade

**Step 1:** Determine the Annual Solar Access: For the solar ready requirements, solar access is the ratio of solar insolation including shading to the solar insolation without shading. Annual solar access is most easily determined using specialized software.

$$\text{Solar Access} = \frac{\text{Solar Insolation Including Shading}}{\text{Solar Insolation Without Shading}}$$

Solar access does not consider shading from objects that are included in the building project because these are considered part of the building and the designer has control of these potential obstructions. These include the building itself, HVAC equipment, outdoor lights, landscape features and other similar objects. Objects that are not part of the building project cannot be moved or modified as part of the project and include existing buildings, telephone poles, communication towers, trees, or other objects.

Evaluate whether there are any objects outside the building project that will shade the rooftop (or other prospective solar zone areas such as overhangs or parking shade structures). If an existing object is located north of all potential solar zones, the object will not shade the solar zone.

**Step 2:** Determine the Potential Solar Zone Area: On low-sloped roofs, the potential solar zone is the area where annual solar access is  $\geq 70$  percent.

On steep-sloped roofs the potential solar zone is the area where the annual solar access is  $\geq 70$  percent on the portion oriented between 90 and 300 degrees of true north.

**Step 3:** Determine the size of the designated solar zone. The designated solar zone must be  $\geq 50$  percent of the potential solar zone area. If the roof is shaded such that there is no potential solar zone area, then no solar zone is required. See Figure 7.1. Document the method/tools used to demonstrate that the solar access is less than 70 percent in the compliance form CF1R-SRA-02-E (Minimum Solar Zone Area Worksheet).

#### Example 7-13

Question:

A house has a total roof area of 2,500 SF. The neighbor's house and trees shade the roof, so 2,100 SF of the roof has less than 70 percent annual solar access. How big does the solar zone have to be?

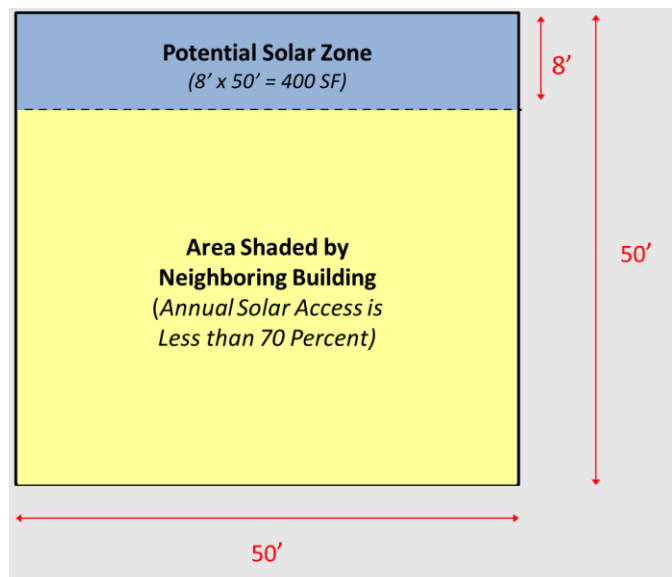

Answer:

If the entire roof were to have an annual solar access of 70 percent or greater, the minimum solar zone would have been 250 SF. Since the potential solar zone is only 2,500 – 2,100 = 400 SF, however, the minimum solar zone can be reduced to 50 percent of the potential solar zone, or 200 SF.

Exception 5 allows a reduced solar zone of  $\geq 150$  square feet if all thermostats have demand responsive controls. See Appendix H of this compliance manual for guidance on compliance with the demand responsive control requirements.

Exception 6 allows no solar zone when the following energy efficiency features are met:

1. All thermostats have demand responsive controls that comply with Section 110.12(a) and Joint Appendix JA5 (please see Exception 5, above, for more details), AND
2. Compliance with one of the following:
  - a. Install a:
    - i. a dishwasher that meets or exceeds the ENERGY STAR® program requirements WITH a refrigerator that meets or exceeds the ENERGY STAR program requirements; or
    - ii. a whole-house fan driven by an electronically commutated motor; or
    - iii. an SAE J1772 Level 2 Electric Vehicle Supply Equipment (EVSE or EV Charger) with a minimum of 40 amperes. SAE J1772 is the SAE

International document titled "SAE Electric Vehicle and Plug in Hybrid Electric Vehicle Conductive Charge Coupler" (SAE J1772\_201710)

- b. Install a home automation system that is capable of, at a minimum, controlling the appliances and lighting of the dwelling and responding to demand response signals; or
- c. Install alternative plumbing piping to permit the discharge from the clothes washer and all showers and bathtubs to be used for an irrigation system in compliance with the *California Plumbing Code*; or
- d. Install a rainwater catchment system designed to comply with the *California Plumbing Code* and uses rainwater flowing from at least 65% of the available roof area.

---

#### Example 7-14 Solar Ready Zone

Question:

What are the examples of how the solar-ready zone requirements can be avoided using Exception 6?

Answer:

Exception 6 provides three options for avoiding the solar-ready zone requirements altogether:

1. Install only demand responsive capable (DRC) thermostats with ENERGY STAR® dishwasher and refrigerator, or
2. Install only DRC thermostat(s) and a whole-house fan driven by an electronically commutated motor, or
3. Install only DRC thermostat(s) and a level 2 EV charger with a minimum of 40 amperes.

Any of these three options can be used to avoid the solar ready zone requirements.

---

#### 7.6.3 Azimuth (Solar Zone)

<i>§110.10(b)2</i>
--------------------

All sections of the solar zone on steep-sloped roofs (rise-to-run ratio greater than 2:12, or 10 degrees) must be oriented between 90 degrees and 300 degrees of true north. The orientation ensures a reasonable solar exposure if a solar energy system is installed in the future. On a low-sloped roof (rise-to-run ratio equal to or less than 2:12, or 10 degrees), the azimuth requirement does not apply.

Figure 7-4: Orientation when solar zone is located on a steep-sloped roof

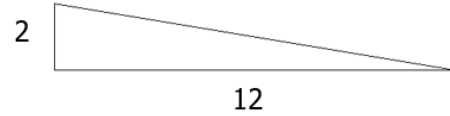
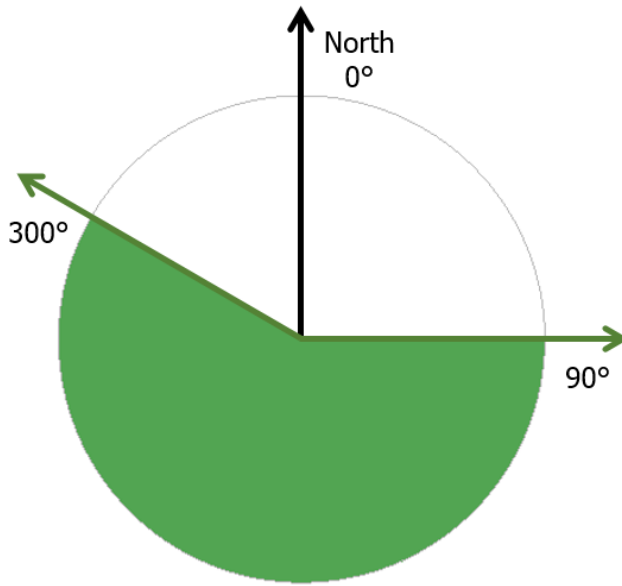

If solar zone is located on a sloped roof with a rise to run ratio greater than 2:12 (see above), then the roof must face between 90° and 300°

### 7.6.4 Shading (Solar Zone)

*§110.10(b)3*

The solar zone must be free from roof penetrations and shall not have any obstructions such as vents, chimneys, architectural features, or roof-mounted equipment located in the solar zone. This requirement ensures that the solar zone remains clear and open for the future installation of a solar energy system.

Any obstruction located on the roof or any other part of the building that projects above the solar zone must be located at a sufficient horizontal distance away from the solar zone in order to reduce the resulting shading of the solar zone. For each obstruction, the horizontal distance ("D") from the obstruction to the solar zone shall be at least two times the height difference ("H") between the highest point of the obstruction and the horizontal projection of the nearest point of the solar zone.

$$\text{Shading Equation: } D \geq 2 \times H$$

Figure 7-5: Schematic of Allowable Setback of Rooftop Obstructions

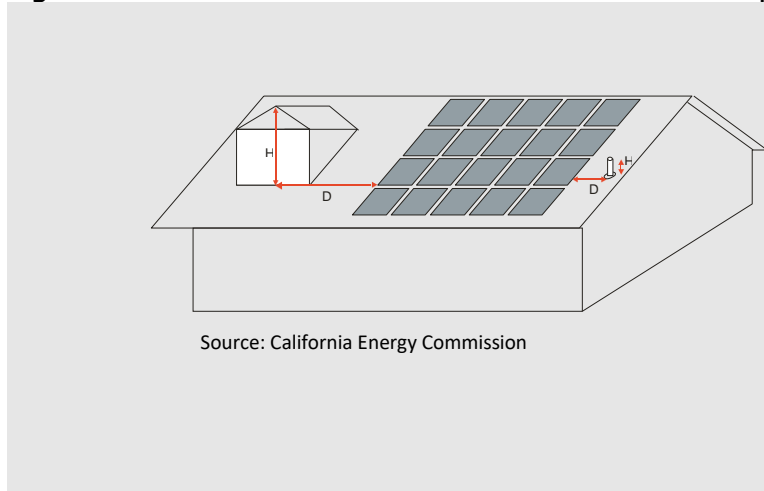

Any obstruction that is not located on the roof or another part of the building, such as landscaping or neighboring building, or is oriented north of all points of the solar zone is not subject to the shading requirement.

### 7.6.5 Structural Design Loads (Solar Zone)

The structural design loads for roof dead load and roof live load must be clearly indicated on the construction documents for the designated solar zone areas. The structural load information will be easily available if the building owner considers a solar energy system installation in the future. It is not necessary to estimate the collateral loads for future solar energy systems.

### 7.6.6 Interconnection Pathways

#### *§110.10(c)*

All buildings that comply by designating a solar zone must also include a plan for connecting a future PV and SWH system to the building's electrical or plumbing system. The construction documents must indicate:

1. A reserved location for inverters and metering equipment for solar electric systems.
2. A reserved conduit route from the solar zone to the point of interconnection with the electrical service. There is no requirement to install any conduit.
3. For homes with a central water heating system, a reserved plumbing pathway from the solar zone to the water-heating system connection. There is no requirement to install any plumbing.

### 7.6.7 Documentation

#### *§110.10(d)*

A copy of the construction documents or a document containing the required solar-ready information must be provided to the occupant. The building occupant must also receive a

copy of the associated installation forms CF2R-SRA-01-E and CF2R-SRA-02-E. Providing this information to the building occupant is required so the information is available if the owner decides to install a solar energy system in the future. Construction documents must include information about the as-designed structural loads, solar zone location, and the reserved interconnection pathways.

### 7.6.8 Main Electrical Service Panel

#### **§110.10(e)**

The main electrical service panel must have a minimum busbar rating of 200 amps. The panel must also include space for a future install of a double-pole circuit breaker, if one is not installed during construction, and must be permanently marked "For future solar electric". These items are required to simplify the possible future installation of a solar electric system.

---

## **7.7 California Fire Code Solar Access Requirements**

Under regulations established by the Office of the State Fire Marshal, the 2022 version of Parts 2, 2.5, and 9 of Title 24 include requirements for the installation of rooftop solar photovoltaic systems. These regulations cover the marking, location of DC conductors, and access and pathways for photovoltaic systems. They apply to residential and nonresidential buildings regulated by Title 24 of the California Building Standards Codes. Provided below is a brief summary of the fire code requirements for residential buildings.

PV arrays shall not have dimensions in either axis greater than 150 feet. Residential buildings with hip, ridge/valley roof features shall provide a 3-foot access pathway away from applicable eave to hip/ridge/valley features. To provide adequate smoke ventilation, PV arrays shall not be located higher than 3 feet below the ridge. Builders shall refer directly to the relevant sections of Title 24 (most currently Part 2.5 Section R324.3, and Part 2.5 Section 324.6) for detailed requirements.

In addition to the requirements in the fire code, the California Department of Forestry and Fire Protection – Office of the State Fire Marshal (CAL FIRE-OSFM), local fire departments (FD), and the solar photovoltaic industry previously developed a *Solar Photovoltaic Installation Guideline* to increase public safety for all structures equipped with solar photovoltaic systems. The intent of this guideline is to provide the solar PV industry with information that will aid in the designing, building, and installation of solar PV systems in a manner that should meet the objectives of both the PV industry and the requirements set forth in the California Fire Code.

The entire [Solar Photovoltaic Installation Guideline](http://opr.ca.gov/docs/20190226-Solar_Permitting_Guidebook_4th_Edition.pdf) can be accessed at [http://opr.ca.gov/docs/20190226-Solar\\_Permitting\\_Guidebook\\_4th\\_Edition.pdf](http://opr.ca.gov/docs/20190226-Solar_Permitting_Guidebook_4th_Edition.pdf)



---

## 7.8 Battery Ready Overview

All single-family homes with one or two dwelling units must be Energy Storage System (ESS) ready to facilitate the future installation of a battery system. The following requirements must be met. There are no exceptions.

1. At least one of the following shall be provided:
  - a. ESS ready interconnection equipment with a minimum backed up capacity of 60 amps and a minimum of four ESS supplied branch circuits- or
  - b. A dedicated 1" minimum raceway from the main service to a subpanel that supplies the branch circuits described in #2 below. The subpanel must be labeled "Subpanel shall include all backed-up load circuits." All branch circuits are permitted to be supplied by the main service panel prior to the installation of an ESS.
2. A minimum of four branch circuits shall be identified and have their source of supply collocated at the subpanel referenced in #1b above to be supplied by the ESS. At least one circuit must supply the refrigerator, one lighting circuit near the primary egress, and at least one circuit shall supply a sleeping room receptacle outlet. There is no requirement for what is supplied by the fourth circuit.
3. The main panelboard shall have a minimum busbar rating of 225 amps.
4. Sufficient space shall be reserved to allow future installation of a system isolation equipment/transfer switch within 3 feet of the main panelboard. Raceways shall be installed between the panelboard and the system isolation equipment transfer switch location to allow the connection of backup power source.

---

## 7.9 Compliance and Enforcement

When a building permit application is submitted to the enforcement agency, the applicant also submits plans and energy compliance documentation. This section describes the forms and procedures for documenting compliance with the solar ready requirements of the Energy Standards. The following discussion is addressed to the designer preparing construction and compliance documents, and to the enforcement agency plan checkers who are examining those documents for compliance with the standards.

There are three forms associated with the low-rise residential solar-ready requirements. Each form is briefly described below.

CF2R-SRA-01-E: Certificate of Installation: Solar Ready Areas

This form is required for newly constructed single-family residential and low-rise multifamily projects that do not include solar PV systems. This form documents what was installed to comply with the solar-ready requirements, including any equipment installed to qualify for one of the solar zone exceptions.

CF2R-SRA-02-E: Certificate of Installation: Minimum Solar Zone Area Worksheet

This form is required when buildings comply with the solar-ready requirement by including a solar zone. That is, an appropriately sized solar PV system is not installed, an appropriately sized solar water heating system is not installed, the building does not comply with all the DRC requirements, or the roof is not designed for vehicle traffic or a heliport.

CF2R-STH-01-E: Certificate of Installation: Solar Water Heating System

Single-Family Residential Only: This form is required when a compliant solar water-heating system has been installed on the home to meet solar zone Exception 1.

---

## Table of Contents

8	Performance Method .....	8-1
8.1	Overview .....	8-1
8.2	What’s New for 2022.....	8-2
8.2.1	Determining Compliance – Energy Design Rating (EDR) .....	8-2
8.2.2	Major Changes Affecting Standard Design Efficiency .....	8-2
8.2.3	New HERS Verification Requirements .....	8-2
8.3	Compliance Basics .....	8-3
8.3.1	Compliance Process .....	8-3
8.3.2	Defining the Standard Design Efficiency.....	8-4
8.3.3	Professional Judgment .....	8-5
8.4	Subdivisions and Master Plans .....	8-6
8.4.1	Individual Building Approach.....	8-6
8.4.2	Multiple Orientation Alternative: No Orientation Restrictions .....	8-7
8.5	HVAC Issues.....	8-8
8.5.1	No Cooling Installed.....	8-8
8.5.2	Wood Heat.....	8-8
8.5.3	Multiple HVAC Systems.....	8-8
8.5.4	HERS Verified Efficiency .....	8-9
8.5.5	Existing + Addition + Alteration Approach.....	8-9

---

## 8 Performance Method

---

### 8.1 Overview

This chapter explains the performance method of complying with the *Building Energy Efficiency Standards* (Energy Standards). The performance method provides maximum flexibility to trade off the energy performance of different building components to achieve compliance. For new construction, the energy budget is expressed in terms of the Energy Design Ratings (EDR), which are based on source energy and time-dependent valuation (TDV) energy. The EDR is a score from 0 to 100, where 0 represents a building that has zero net energy consumption based on the TDV energy consumption and 100 represents a building that meets the 2006 International Energy Conservation Code. This is the same criteria for a score of 100 for the National Home Energy Rating System. Energy Commission-approved compliance software programs calculate an EDR for the building (proposed efficiency) and compare it to the energy budget (standard efficiency). Approved compliance programs also calculate an EDR for proposed photovoltaic (PV)/demand flexibility and compare it to the standard PV/flexibility budget.

Energy Design Rating 1 (EDR1) is based on hourly source energy. Energy Design Rating 2 (EDR2) is based on TDV energy and has two components, the Energy Efficiency Design Rating and the Solar Electric Generation and Demand Flexibility Design Rating. The Total Energy Design Rating accounts for both the Energy Efficiency Design Rating and the Solar Electric Generation and Demand Flexibility Design Rating. The proposed building must separately comply with the Source Energy Design Rating (EDR1), Energy Efficiency Design Rating (Efficiency EDR2) and the Total Energy Design Rating (Total EDR2).

The standard efficiency includes water heating, space heating, space cooling, indoor air quality (IAQ) fan energy, and solar generation. Energy use from lighting and appliances is not eligible to be traded off.

The Energy Commission-approved compliance software programs calculate space-conditioning and water-heating energy use in accordance with a set of rules. Modeling capabilities are in the *Residential Alternative Calculation Method (ACM) Reference Manual*. All approved software programs use the California simulation engine to simulate the energy use, and the same report generator to create the certificate of compliance (CF1R), as the public domain program, California Building Energy Code Compliance - Residential (CBECC-Res). Approved software vendors have can create their own user interface, documentation, and additional forms. Each approved program is required to have a compliance supplement with information on how to use the software, as specified in the *ACM Approval Manual*.

A discussion of the performance method for additions and alterations is in Chapter 9.

---

## 8.2 What’s New for 2022

### 8.2.1 Determining Compliance – Energy Design Rating (EDR)

The EDR1 score is a metric of a building’s hourly source energy divided by the reference design hourly source energy budget. An EDR1 score is calculated for the proposed design and a second EDR1 score is calculated for the standard design. The proposed design EDR1 must be equal to or less than the standard design EDR1.

An EDR2 score of zero represents a building that has zero-net-energy performance based on the TDV energy consumption, and an EDR2 score of 100 represents a building that is minimally compliant with the 2006 International Energy Conservation Code. The EDR2 score is a ratio of a building’s TDV budget to reference design TDV budget.

An Efficiency EDR2 and Total EDR2 score are calculated for the proposed design and a second Efficiency EDR2 and Total EDR2 score are calculated for the standard design. Compliance with EDR2 requires meeting two criteria:

1. Proposed design Efficiency EDR2 must be equal to or less than standard design Efficiency EDR2. The EDR2 is established by the ratio of the standard design or space heating, space cooling, IAQ ventilation, water heating, and self-utilization credit energy consumption, and reference design energy consumption of the same end uses.
2. Total EDR2 (Efficiency EDR2, plus PV/flexibility EDR2) of the proposed design must be equal to or less than the Total EDR2 of the standard design. The Total EDR2 is established by the ratio of the standard design or proposed design efficiency end uses plus interior lighting, appliances, cooking, plug loads, exterior lighting, and PV generation and flexibility measures energy consumption of the standard design and the total EDR2 of the reference design.

### 8.2.2 Major Changes Affecting Standard Design Efficiency

The standard design efficiency is based on the prescriptive requirements in Table 150.1-A. The 2022 Energy Code prescriptively requires heat pump space heating in climate zones 3, 4, 13 and 14, and heat pump water heaters for domestic hot water (DHW) systems in all other climate zones. Additionally, a new exception for cooling ventilation has been added for new single family dwellings with a conditioned floor area of 500 square feet or less. There also is a new exception for an instantaneous electric resistance water heater with point of use distribution for new single family dwellings with a conditioned floor area of 500 ft<sup>2</sup> or less.

### 8.2.3 New HERS Verification Requirements

Variable capacity heat pumps will require verification of the following features: (1) installed system must have refrigerant charge verified according to the applicable procedures in RA3.2; (2) ducted indoor units shall be verified to meet the verified

low-leakage ducts in conditioned space requirements according to the procedure in RA3.1.4.3.8; (3) ductless systems shall be verified to visually confirm ductless indoor units are located entirely in conditioned space, (4) confirm that all habitable rooms are provided with conditioned airflow; (5) confirm zones greater than 150 square feet have a wall mounted thermostat; (6) confirm that the manufacturer's model number of installed ducted units are included in listings of certified low-static pressure VCHP system published on the Energy Commission's website; (7) if non-continuous fan operation is claimed for credit in the compliance software, verification shall confirm that the installed system's indoor unit + outdoor unit combination is certified to the Energy Commission and listed on the Energy Commission website as a type that does not operate the fan continuously by default; (8) each new ducted indoor unit must have airflow verified to confirm the airflow at full capacity in cooling mode is equal to or greater than 350 cfm/ton of nominal cooling capacity of the indoor unit, and 300 cfm/ton for altered systems; and (9) verification shall confirm the air filter sizing is correct, and confirmed the installed air filter label specifies performance that meets a clean filter pressure drop less than or equal to 0.1 inch wc. at design airflow rate.

---

## 8.3 Compliance Basics

### 8.3.1 Compliance Process

Any approved computer program may be used to show compliance with the Energy Code using the performance method. The following steps are an outline of the typical computer program procedure:

1. Collect all necessary data on each component.
  - a. For the building envelope, the area of each fenestration, wall, door, roof, ceiling, and floor is needed. For each component, the applicable energy characteristics needs to be defined including U-factor, solar heat gain coefficient (SHGC), solar reflectance, and thermal mass values.
  - b. For HVAC systems, the equipment type and efficiency are required. For hydronic space heating, the specific water heater type and efficiency are required. For fan-forced air conditioning systems, the location and amount of insulation on the duct system are needed.
  - c. For DHW systems, the water heater type, number, efficiency, and area served are required, along with the information about the hot water distribution system. Additional information will be required for features such as solar thermal systems and drain water heat recovery devices. More information is in Chapter 5.
  - d. For PV systems, size and location information--such as roof slope and orientation-- are required. Battery storage capacity and control information must be described if battery storage is proposed. Refer to Chapter 7 for more information.

2. Enter the basic building envelope data such as square footage, number of stories, occupancy type, and climate zone. Define each opaque surface with the orientation, area, and thermal performance properties. Add the doors and fenestration associated with each opaque surface, including any fixed shading such as overhangs and side fins. Enter the data of the equipment and distribution systems for the space conditioning and water-heating systems. The input values and assumptions must correspond to the information on the final approved plan set, and the inputs must be at least as energy efficient as the relevant mandatory measures. (Software compliance programs may not automatically check for compliance with mandatory measures.)
3. Launch a computer simulation to calculate the source EDR1, efficiency EDR2, and total EDR2 of the standard design and the proposed design.

For additions and alterations, compliance is based on TDV energy, and not the EDR criteria that is used for newly constructed buildings. In existing buildings, where the values of installed features are unknown, default values may be used based on the year of the construction. Refer to Table 8-1, Default Assumptions for Year Built (Vintage), at the end of this chapter. The proposed design complies if all mandatory measures are met and the total TDV energy use is the same as or less than the standard design TDV energy budget.

When creating a computer input file, use the space provided for the project title information to concisely describe the building being modeled. User-designated names should be clear and internally consistent with other orientations and/or surfaces being analyzed. Title names and explanatory comments should assist in the compliance and enforcement processes.

### 8.3.2 Defining the Standard Design Efficiency

Approved compliance software programs automatically calculate the standard design efficiency based on data entered for the proposed building.

The program defines the standard building by modifying the geometry of the proposed building and inserting the features of Table 150.1-A of the Energy Standards. Details on how the proposed and standard design energy budget are established can be found in the *Residential ACM Reference Manual*.

Note the details of how the standard design efficiency is determined. Deviations from the prescriptive requirements will be reflected in the compliance margin. For example, if the prescriptive requirements from Table 150.1-A include a heat pump space heating system, and the proposed building is modeled with a central gas furnace, it will significantly increase the heating source energy and result in a compliance penalty.

The standard design assumes the same total conditioned floor area and volume as the proposed design and the same gross exterior wall area as the proposed design, except that the wall area in each of the four cardinal orientations is divided equally. The standard design uses the same roof/ceiling area, raised floor area, slab-on-

grade area, and perimeter as the proposed design, but uses the standard insulation R-values from Table 150.1-A of the Energy Code.

The standard design includes all features of the prescriptive compliance tables, including quality installation of insulation, walls with the prescriptive U-factor, below-deck roof insulation or radiant barrier, and a solar PV system.

Total fenestration area in the standard design is equal to that in the proposed design if the fenestration area in the proposed design is less than or equal to 20 percent of the conditioned floor area (CFA). Otherwise, the fenestration area is equal to 20 percent of the CFA. Fenestration area in the standard design is evenly distributed among the four cardinal orientations. SHGC and U-factors in the standard design are the same as those listed in the prescriptive tables, with no overhangs.

The standard design includes minimum efficiency heating and cooling equipment, as well as the minimum duct insulation R-value required for Option B from Table 150.1-A of the Energy Code. Ducts are assumed to be sealed as required by §150.0(m). The standard design also assumes correct refrigerant charge as required by §150.1(c)7A.

For water-heating systems that serve dwelling units, the standard design is a NEEA Tier 3 heat pump water heater with a uniform energy factor equal to 2.0, and the distribution system meets all mandatory requirements specified in §150.0.

### **8.3.2.1 Standard Reports**

For consistency and ease of enforcement, the way building features are reported by compliance software programs is standardized. Energy Commission-approved compliance software programs produce compliance reports in a standard format. The principal report is the certificate of compliance (CF1R-PRF-01-E).

The CF1R-PRF-01-E includes two feature summary sections, one for required special features and modeling assumptions, and a second for features requiring HERS field verification and/or diagnostic testing. These sections provide a general overview during compliance verification by the local enforcement agency and the HERS Rater. Items in the special features and modeling assumptions section indicate that if such features or assumptions used for compliance are not installed, the building would not comply, and they call for special consideration by the local enforcement agency. Items in the HERS verification section rely on diagnostic testing and verification by an approved HERS Rater to ensure proper field installation. Diagnostic testing and verification by HERS Raters is separate from local enforcement agency inspections.

### **8.3.3 Professional Judgment**

Some modeling techniques and compliance assumptions applied to the proposed design are fixed or restricted. At other times, professional judgment may be acceptable or necessary.



Enforcement agencies can reject a particular input if the permit applicant cannot substantiate the value with supporting documentation or demonstrate that appropriate professional judgment was applied.

A simplified approach or assumption should be consistent with what is used by the compliance software to generate the standard design. If simplification increases the predicted energy use of the proposed building or reduces the compliance margin when compared to a more detailed modeling assumption, the simplification is acceptable. Simplification must reflect a worse case than a more detailed model and result in the same or lower compliance margin.

Any unusual modeling approach, assumption, or input value should be documented with published data and conform to standard engineering practice.

For assistance evaluating the appropriateness of input assumptions, contact the provider of your compliance software or the Energy Commission's Energy Standards Hotline ([Title24@energy.ca.gov](mailto:Title24@energy.ca.gov) or (800) 772-3300).

---

### **Example 8-1**

#### **Question**

Three different-sized windows in the same wall of a new home are designed without exterior shading. They have the same National Fenestration Rating Council-rated U-factors and SHGC values. Is it acceptable to simplify the computer model by adding the areas of the windows and inputting them as a single fenestration area?

#### **Answer**

Yes. Because modeling the windows as a single window will not increase or decrease the modeled energy consumption, this is acceptable. However, plan checking and finding errors when windows are combined is much more difficult. If the software has a multiplier, identical window sizes with identical shading features can be combined. Otherwise, it is best practice to model each window individually.

---

## **8.4 Subdivisions and Master Plans**

Subdivisions often require a special approach to energy compliance because they have one or a few basic building or unit plans repeated in a variety of orientations. The basic floor plans may also be used in a mirrored or reversed configuration.

There are two compliance options for subdivisions:

- Model each individual building, or building condition, separately according to the actual orientation.
- Model all four cardinal orientations for each building or plan type with identical conservation features for no orientation restrictions.

### **8.4.1 Individual Building Approach**

The most straightforward option for subdivisions is analyzing each building in the project separately using any compliance method. This may be practical for

subdivisions with only custom buildings, or with only one or two specific orientations for each building plan. This approach requires that each unit comply separately, with separate documentation submitted for each unit plan in the orientation in which it will be constructed.

**8.4.2 Multiple Orientation Alternative: No Orientation Restrictions**

*§150.1(b)*

The performance method may be used to demonstrate that a building plan complies regardless of its orientation within the same climate zone. To ensure compliance in any orientation, the annual energy consumption must be calculated using all four cardinal orientations (a single CF1R with results for north, east, south, and west). The building must have the identical efficiency measures and levels, and comply with the energy budget in all orientations. Cardinal compliance can be used to show compliance for a reversed floor plan.

**Figure 8-2: Subdivisions and Master Plans Compliance Option**

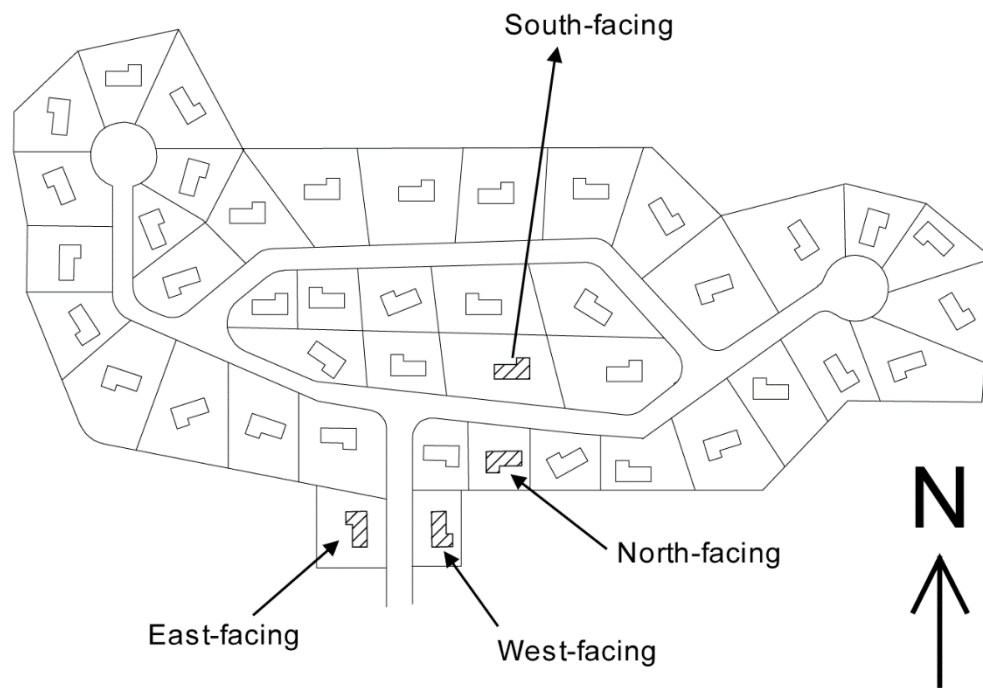

***Demonstrate Compliance for Each Cardinal Orientation for Each Basic Model Type***

***Source: California Energy Commission***

For compliance, submit certificate of compliance documentation of the energy budgets for each of the four orientations to the enforcement agency. Only one CF1R compliance document that shows compliance for all four orientations is required to be submitted to the enforcement agency for each unique or reverse plan.

Master plans that use the multiple orientation alternative must establish a connection to the CF1R in the HERS registry. For the multiple orientation compliance approach in a master plan subdivision, the required documentation for each dwelling unit should be a multiple orientation master plan certificate of compliance (CF1R), a dwelling-specific certificate of installation (CF2R), and a dwelling-specific certificate of verification (CF3R).

---

## 8.5 HVAC Issues

### 8.5.1 No Cooling Installed

When a building has no cooling system, the software simulates a hypothetical system with the characteristics required by Table 150.1-A as if a cooling system were installed. The result is neither a penalty nor a credit.

### 8.5.2 Wood Heat

When natural gas is not available, and all other eligibility criteria are met (see Chapter 4), a wood heating system is simulated as a hypothetical system with the characteristics required by Table 150.1-A or -B for a typical heating system. When all eligibility criteria are met, the backup system is not modeled; otherwise, see Section 8.5.3.

### 8.5.3 Multiple HVAC Systems

Buildings with multiple HVAC systems are treated as follows:

1. For buildings with more than one system type, equipment type, or fuel type, where the types do not serve the same floor area, model the building zone or floor area served by each unique type separately.
2. Supplemental heating may be ignored if (1) the capacity of the supplemental unit does not exceed 2 kilowatts (kW) or 7,000 British thermal units per hour, and (2) the supplemental unit is controlled by a time-limiting device that does not allow it to run for more than 30 minutes. (§150.1[c]6.)

In a building with a central gas furnace and an appliance-rated gas fireplace, the furnace is the primary system, and the fireplace is the supplemental system. In this case, the controls for the fireplace would not need to meet the setback thermostat requirements (Exception to §110.2[c]).

3. For single family buildings served by more than one heating or cooling system, equipment type, or fuel type, model the least efficient system. For any areas served by electric resistance heat and another heating system (except for wood heating meeting all eligibility criteria), the electric resistance system is the least efficient system.

When there is more than one system meeting the heating or cooling load for the same space, all systems must meet all mandatory requirements of the Energy Standards.

### **8.5.4 HERS Verified Efficiency**

When higher than minimum efficiency is modeled, a HERS Rater must verify the efficiency. This includes:

- Seasonal Energy Efficiency Ratio (SEER) or Seasonal Energy Efficiency Ratio 2 (SEER2)
- Energy Efficiency Ratio (EER) or Energy Efficiency Ratio 2 (EER2)
- Combined Energy Efficiency Ratio (CEER)
- Heating Seasonal Performance Factor (HSPF) or Heating Seasonal Performance Factor 2 (HSPF2)

### **8.5.5 Existing + Addition + Alteration Approach**

The performance approach may be used to show compliance for alterations to existing buildings, additions, and existing + addition + alteration as discussed in Chapter 9. When existing conditions are unknown, the default assumptions in Table 8-1 must be used. The standard design for an altered component shall be the higher efficiency of existing conditions or the requirements stated in Table 8-1 Standard Design for an Altered Component. For components not being altered, the standard design shall be based on the existing conditions. When the third-party verification option is specified as a requirement, all components proposed for alteration for which the additional credit is taken must be verified.

**Table 8-1 Standard Design for an Altered Component**

<b>Altered Component</b>	<b>Standard Design Without Third Party Verification of Existing Conditions Shall be Based On</b>	<b>Standard Design With Third Party Verification of Existing Conditions Shall be Based On</b>
Ceiling Insulation, Wall Insulation, and Raised-floor Insulation	The requirements of Sections 150.0(a), (c), and (d)	The existing insulation R-value
Fenestration	The U-factor of 0.40 and SHGC value of 0.35. The glass area shall be the glass area of the existing building.	If the proposed U-factor is $\leq 0.40$ and SHGC value is $\leq 0.35$ , the standard design shall be based on the existing U-factor and SHGC values as verified. Otherwise, the standard design shall be based on the U-factor of 0.40 and SHGC value of 0.35. The glass area shall be the glass area of the existing building.
Window Film	The U-factor of 0.40 and SHGC value of 0.35.	The existing fenestration in the alteration shall be based on Table 110.6-A and Table 110.6-B.
Doors	The U-factor of 0.20. The door area shall be the door area of the existing building.	If the proposed U-factor is $< 0.20$ , the standard design shall be based on the existing U-factor value as verified. Otherwise, the standard design shall be based on the U-factor of 0.20. The door area shall be the door area of the existing building.
Space-Heating and Space-Cooling Equipment	TABLE 150.1-A for equipment efficiency requirements; Section 150.2(b)1C for entirely new or complete replacement systems; Section 150.2(b)1F for refrigerant charge verification requirements.	The existing efficiency levels.
Air Distribution System – Duct Sealing	The requirements of Sections 150.2(b)1D and 150.2(b)1E	The requirements of Sections 150.2(b)1D and 150.2(b)1E
Air Distribution System – Duct Insulation	The proposed efficiency levels.	The existing efficiency levels.
Water Heating Systems	The requirements of Section 150.2(b)1Hii	The existing efficiency level.
Roofing Products	The requirements of Section 150.2(b)1I.	The requirements of Section 150.2(b)1I
All Other Measures	The proposed efficiency levels.	The existing efficiency levels.

SOURCE: California Energy Commission Energy Code Table 150.2-D

**Table of Contents**

9 Additions, Alterations, and Repairs ..... 1

  9.1 Introduction ..... 1

    9.1.1 Additions ..... 2

    9.1.2 Alterations ..... 2

    9.1.3 Repairs..... 3

  9.2 What’s New in the 2022 Energy Code ..... 5

    9.2.1 Building Envelope ..... 6

    9.2.2 Mechanical Ventilation ..... 6

    9.2.3 Space Conditioning System ..... 6

    9.2.4 Prescriptive Alterations ..... 7

    9.2.5 Water Heating New, more specific language specifying which water heating systems are allowed prescriptively ..... 7

  9.3 Compliance Approaches..... 7

    9.3.1 Additions ..... 8

    9.3.2 Additions and Alterations Combined .....10

    9.3.3 Alterations Only.....10

    9.3.4 Wall Exceptions to Continuous Insulation .....11

    9.3.5 Accessory Dwelling Units (ADUs) .....12

  9.4 Prescriptive Approach and Mandatory Requirements .....16

    9.4.1 Prescriptive Additions.....16

    9.4.2 Water Heating System .....24

    9.4.3 Alterations – Prescriptive/Mandatory Requirements .....25

    9.4.4 Envelope Alterations .....25

    9.4.5 Water Heating Alterations .....48

    9.4.6 HVAC System Alterations .....51

    9.4.7 Mechanical Ventilation for Additions and Alterations .....58

    9.4.8 Lighting for Additions and Alterations.....60

  9.5 Performance Approach .....62

    9.5.1 Performance: Addition Alone .....62

9.5.2 Performance Method: Additions and Existing + Addition + Alterations Approach ..... 62

9.5.3 Existing + Addition + Alterations Without Third-Party Verification ..... 64

9.5.4 Existing + Addition + Alterations With Third-Party Verification..... 65

9.5.5 Existing + Addition + Alterations as New Construction ..... 65

9.5.6 Summary of Modeling Rules ..... 65

# 9 Additions, Alterations, and Repairs

## 9.1 Introduction

This chapter covers key aspects of how the *2022 Building Energy Efficiency Standards* (Energy Code) apply to the construction of additions and/or alterations to an existing residential building. As explained below, the Energy Code does not apply to building repairs.

The chapter is organized as follows:

1. **Section 9.1 – Introduction.** Highlights the applicable standards definitions for additions, alterations, and repairs and provides several examples of each.
2. **Section 9.2 – What’s New in the 2022 Energy Code.** Highlights of the requirements and compliance options in the 2022 Energy Code.
3. **Section 9.3 – Compliance Approaches.** An overview of prescriptive and performance compliance options.
4. **Section 9.4 – Prescriptive Approach and Mandatory Requirements.** Detailed information on prescriptive compliance methods for additions and alterations, including how mandatory requirements apply.
5. **Section 9.5 – Performance Approach.** An explanation of computer simulation of compliance for building additions, including existing + addition + alterations.

When additions and alterations include changes to the building envelope, mechanical systems, and/or water heating systems, a certificate of compliance form (CF1R) must be completed and submitted with the building permit application:

- If complying prescriptively, CF1R-ADD-01 and/or CF1R-ALT-02 forms are used.
- For the performance approach, compliance software produces a CF1R-PRF-01. (See Appendix A for a list of forms.)

Changes to HVAC systems will likely include one or more features that require Home Energy Rating System (HERS) field verification and diagnostic testing. If HERS verification is required, the certificate of compliance must be completed and registered online with an approved HERS provider using the provider’s website. Refer to Chapter 2 for information about document registration and refer to Residential Appendix RA2 for more information about HERS verifications.

For a list of appropriate compliance documents refer to Appendix A of this manual.



### 9.1.1 Additions

An *addition* is any change to an existing building that increases conditioned floor area and conditioned volume (including conditioning a previously unconditioned space). See §100.1.

Examples of an addition include:

1. Adding a conditioned sunroom or other living space to an existing house.
2. Converting a garage or other existing unheated space into living space.
3. Enclosing and conditioning an existing patio area.
4. Obtaining a permit to legalize an existing, habitable, conditioned space that was previously added to a residential building without a permit.
5. Adding a bay window that extends from floor to ceiling, thereby increasing both floor area and volume.

### 9.1.2 Alterations

An *alteration* is any change to a water-heating system, space-conditioning system, lighting system, or envelope of a building that is not an addition. See §100.1.

Examples of alterations include:

1. Adding insulation to an existing ceiling, exterior roof, exterior wall, or raised floor that is over a crawl space, garage, or unheated basement.
2. Replacing or installing a new finish surface to an existing roof (reroofing) and replacing either portions of or the entire roof assembly.
3. Replacing existing fenestration or adding fenestration area (for example, windows, glazed doors, dynamic glazing, or skylights) to an existing building.
4. Replacing an existing skylight or increasing the skylight area of an existing roof.
5. Constructing an entirely new roof over an existing conditioned space.
6. Adding a loft within the conditioned volume of an existing home.
7. Replacing an existing space heating system or adding a space heating system (furnace, wall heater, heat pump, or radiant floor).

Note: Adding heating to unconditioned space is an addition, not an alteration.

8. Replacing an existing space cooling system or adding a space cooling system (for example, a central air conditioner or heat pump).
9. Extending or replacing an existing duct system or adding an entirely new duct system.

10. Replacing the existing water heater or adding water heaters and/or hot water piping.
11. Replacing existing hardwired lighting or adding new hardwired lighting fixtures.
12. Adding window film.

### 9.1.3 Repairs

A *repair* is “the reconstruction or renewal for the purpose of maintenance of any component, system, or equipment of an existing building. Repairs shall not increase the pre-existing energy consumption of the repaired component, system, or equipment. Replacement of any component, system, or equipment for which there are requirements in the Energy Code is considered an alteration and not a repair.” (See §100.1).

Note: Repairs to residential buildings are not within the scope of the Energy Code.

For example, when a component, system, or equipment in an existing building breaks or is malfunctioning and maintenance fixes are needed for it to work properly again, it is considered a repair and not subject to the standards. However, if instead of fixing the break or malfunction, the component, system, or equipment is replaced with a new or different one, the scope of work is considered an alteration and not a repair and requirements of the Energy Code must be met.

Examples of work considered repairs include:

1. Replacing a broken pane of glass but not the entire window.
2. Removing fenestration and other envelope components for maintenance or repair, then reinstalling the same fenestration or other envelope components in the same location.
3. Replacing a failed fan motor or gas valve in a furnace but not replacing the entire furnace.
4. Replacing a heating element in a water heater but not replacing the entire water heater.

Note: When any existing envelope component is moved to a new location, even when that location partially overlaps the previous location of the item, the work is considered an alteration.

Note 2: Replacement of some HVAC components needing repair is defined by the Energy Code as an alteration, therefore triggering requirements that must be met. Section 150.2(b)1E of the Energy Code defines the following HVAC component replacements as an alteration that triggers the requirement for duct sealing: “replacement of the air handler, outdoor condensing unit of a split system air conditioner or heat pump, or cooling or heating coil.” Similarly, if more than 25 linear feet of new or replacement space conditioning ducts are installed, then the

entire duct system must be sealed and leakage tested to be equal or less than 10 percent of system air handler airflow. (See §150.2[b]1D.)

*Note 3:* Some cooling system component replacements are defined by the Energy Code as alterations, which require meeting certain requirements. Section 150.2(b)1F of the Energy Code defines installing or replacing a compressor, condensing or evaporator coil, refrigerant metering device, or refrigerant piping as an alteration, which triggers several requirements, including thermostat, and, depending on the climate zone, airflow, and refrigerant charge requirements.

---

### Example 9-1

#### Question:

A sunspace addition is designed with no mechanical heating or cooling and a glass sliding door separating it from all existing conditioned space. This design is approved by the enforcement agency as uninhabitable or unimproved space. Under what conditions will the Energy Code apply to this addition?



*Unconditioned Sunspace*

#### Answer:

The mechanical and envelope requirements of the Energy Code do not apply if the space is not considered habitable or improved and, therefore, can be unconditioned as defined in §100.1; however, per §100.0(c)2, the sunspace must still comply with the applicable lighting requirements of §150.0(k). The sunspace is unconditioned if:

The new space is not provided with heating or cooling (or supply ducts).

All openings between the new space and the existing house can be closed off with weather-stripped doors and windows.

The addition is not indirectly conditioned space (defined in §100.1 under **CONDITIONED SPACE, INDIRECTLY**).

A building official may require a sunspace to be conditioned if it appears to be habitable space, in which case the Energy Code applies.

**Example 9-2****Question:**

An existing duplex is remodeled, which includes only the installation of new faucets and bathroom lighting. Does the Energy Code apply?

**Answer:**

Yes, this remodel is considered an alteration. However, due to the limited scope of work and since no new conditioned space is being created, the remodel must comply only with the applicable mandatory requirements described in §110.1 for appliances and §150.0(k) for residential lighting.

**Example 9-3****Question:**

An existing house is remodeled by adding floor area but not increasing the volume of the house (adding a loft in an area in the house with a vaulted ceiling). As part of this remodel, some windows are replaced, and two windows are being added. Several exterior walls are being opened to install new wiring. What requirements will apply?

**Answer:**

Since floor area is added but not conditioned volume, this is an alteration and not an addition. It must comply with the Energy Code using either the prescriptive method or performance method, and meet all the applicable mandatory requirements. To comply prescriptively, the new and replacement windows must meet the maximum U-factor and solar heat gain coefficient (SHGC) requirements of §150.2(b)1A and B. Newly installed and replacement windows must also comply with the mandatory requirements for caulking/sealing around windows per §110.7. In alterations, it is recommended to install insulation in the exposed walls if no insulation is found when walls are opened; for 2x4 wood framing install the mandatory minimum R-13 and for 2x6 wood framing install R-20.

Alternatively, the performance approach may be used to demonstrate compliance for the entire house, even if individual windows fail to meet the prescriptive requirements, if the building meets all applicable mandatory requirements. At this time, since the exterior walls are exposed or open, this allows the opportunity to insulate the walls and contribute the energy efficiency of the building. Such upgrades are unlikely to contribute to the compliance of the building without third party verification of existing conditions.

---

**9.2 What's New in the 2022 Energy Code**

The 2022 Energy Code includes updates to the mandatory, prescriptive, and performance requirements for additions and alterations. This section highlights the key changes from the 2019 Energy Code. Note that prescriptive compliance requirements may be higher than mandatory requirements.

Multifamily building standards have moved into new sections of the Energy Code. Most documentation and testing will be carried by the ATTCP program, but some requirements for residential buildings three stories and under will continue to require HERS verification. Any HERS-verified projects will be subject to registration with a HERS provider data registry. Refer to the Nonresidential and Multifamily Compliance Manual <Publication Number> for further guidance.

### 9.2.1 Building Envelope

Updated ceiling insulation requirements for alterations in vented attics.

- R-49 ceiling insulation in climate zones 1-3, 6, 8-16. Exception of verified R-19 in climate zones 1, 3, and 6. Section 150.2(b)1Ji.
- Seal all accessible areas of ceiling plane between attic and conditioned space in climate zones 2, 4, and 8-16. Exception 1 and Exception 2. Section 150.2(b)1Jii.
- Insulate over recessed lighting to match ceiling insulation in climate zones 1-4 and 8-16. Use a fire-proof cover if the fixtures are not I-C rated. Section 150.2(b)1Jiii.
- Attic ventilation complies with California Building Code requirements, with exceptions.

### 9.2.2 Mechanical Ventilation

1. An exception was added that exempts Junior Accessory Dwelling Units (JADUs) that are classified as additions to an existing building from whole-building mechanical ventilation requirements. JADUs are dwelling units that are no more than 500 square feet and contained entirely within an existing single-family building,
2. New language clarifying when whole-dwelling unit mechanical ventilation and local mechanical exhaust requirements must be met for additions and alterations.

### 9.2.3 Space Conditioning System

1. The trigger for duct insulation and duct sealing requirements has been revised from 40 feet to 25 feet of altered ducts. The duct requirements apply when any length of duct is extended to serve an addition.
2. Duct insulation levels have been revised. Climate zones 3 and 5-7 require R-6. All other climate zones require R-8.
3. Duct leakage targets have been revised. The duct leakage must now be equal to or less than 10 percent of the system airflow, or the duct leakage to outside must be equal to or less than 7 percent of system airflow.

4. Electric resistance space heating is prohibited as the primary heat source. Replacement space heating systems must be gas or heat pump unless one of the exceptions are met.

### 9.2.4 Prescriptive Alterations

1. Expand the cool roof requirements for steep-sloped roof replacements to Climate Zones 4 and 8-9. The allowable exceptions were also revised.
2. Expand the cool roof requirements for low-sloped roof replacements to Climate Zones 4, 6-12 and 14. The allowable exceptions were also revised.
3. Add a new requirement for roof deck insulation for low-sloped roof replacements in Climate Zones 1, 2, 4, and 8-16. R-14 continuous roof deck insulation or and equivalent assembly roof assembly U-factor of 0.039 is required. Various exceptions to this requirement are allowed.
4. Changes to when replacement electric resistance space heating equipment is allowed when the existing equipment is electric resistance.
5. Reduce the duct sealing target for altered duct and space conditioning systems from 15% to 10% of total duct leakage in all climate zones.
6. Increase the prescriptive duct insulation from R-6 to R-8 in Climate Zones 1-2, 4, 8-10, and 12-13.
7. Reduce the 40-foot trigger for prescriptive duct sealing and insulation to 25-foot for altered systems. Eliminate the minimum length requirement for additions and require duct sealing whenever an existing duct system is extended to serve an addition.
8. Add a prescriptive requirement for insulation and sealing in vented attics for altered ceilings or when an entirely new or complete replacement duct system is installed in a vented attic. The requirements apply in all climate zones except 5 and 7. Various exceptions to this requirement are allowed.
9. New doors that result in an increase in exterior door area must meet the newly constructed buildings requirement of a maximum U-factor of 0.20.

### 9.2.5 Water Heating

New, more specific language specifying which water heating systems are allowed prescriptively

## 9.3 Compliance Approaches

Apart from meeting all applicable mandatory requirements (Section 9.4), additions and alterations must demonstrate compliance using the prescriptive or performance approach.

There are several compliance paths depending on the scope of work:

1. **Addition only:** No changes are made to the existing building except removal of roofs, exterior walls, fenestration, and floors required as a result of the addition.
2. **Alterations only:** There is no addition (no increase in conditioned floor area and volume or adding conditioning to a previously unconditioned space).
3. **Addition and alterations:** There are additions and alterations to the existing building.

For each of these permit scenarios, Table 9-1 summarizes the available compliance approaches for single family residential additions and alterations.

**Table 9-1: Compliance Alternatives for Residential Additions and Alterations**

<b>Project Scope</b>	<b>Prescriptive Approach</b>	<b>Performance Approach<sup>1</sup></b>
1. Alteration only:	Meet all applicable requirements for prescriptive alterations	Existing + Alterations without third party verification of existing conditions; or Existing + Alterations with third party verification of existing conditions; or Existing + Alterations as all newly constructed buildings
2. Addition only:	Additions $\leq 400$ ft <sup>2</sup> ; or Additions $>400$ ft <sup>2</sup> and $\leq 700$ ft <sup>2</sup> ; or Additions $>700$ ft <sup>2</sup>	Addition Alone
3. Addition and existing combined (with or without alteration):	Meet all applicable requirements for prescriptive alterations (if any) and a prescriptive addition approach (see additions only above)	Existing + Addition + Alterations without third-party verification of existing conditions; or Existing + Addition + Alterations with third-party verification of existing conditions; or Existing + Addition + Alterations as all newly constructed buildings

- 1) In the performance approach, the building must be modeled with Energy Commission-approved compliance software, as explained in Chapter 8 of this manual.

### 9.3.1 Additions

Regardless of the compliance approach selected, the following exceptions apply:

1. **Additions of  $\leq 300$  ft<sup>2</sup>** do not require a cool roof product (if required by §150.1[c]11) to be installed.

2. **Whole-house fan (or ventilation cooling)** does not apply to additions of 1,000 ft<sup>2</sup> or less (if otherwise required by §150.1[c]12).
3. **Existing space conditioning systems** that are extended to provide conditioning to an addition are not required to meet the Energy Code (§150.2[a] Exception 4).
4. **Indoor air quality (IAQ)** requirements (§150.0[o]1C, D, or F) do not apply to additions of 1,000 ft<sup>2</sup> or less that are not a new dwelling unit.
5. **Photovoltaic (PV)** requirements do not apply to additions or alterations.
6. **Heat pump space conditioning** requirements do not apply to additions or alterations.

### **A. Addition Alone**

In this compliance scenario, the addition alone is modeled using compliance software, and the existing building is not modeled. This approach can work well when the existing building is not undergoing alterations, and the permitted work scope covers only the addition.

1. **Advantages:** Little information about the existing building is needed (conditioned floor area, number of bedrooms) because it is not modeled.
2. **Disadvantages:** Some prescriptive allowances for additions do not apply to the addition-alone compliance approach. For example, a 400 ft<sup>2</sup> addition has a 30 percent fenestration area limit if complying using existing + addition, while only 20 percent is allowed when complying as an addition alone. Also, with this approach, alterations to the existing building that improve its energy performance cannot be used to “trade-off” requirements for the addition.

### **B. Existing + Addition + Alteration**

In this compliance scenario, the entire building undergoes the compliance analysis, and unaltered building components are not required to be brought into compliance.

1. **Advantages:** This approach offers the most flexibility by modeling improvements to the existing building. The energy budget provides more generous fenestration allowances for prescriptive compliance. Note: There is no requirement to make alterations to the existing building using this approach.
2. **Disadvantages:** Plans and data for the existing building are needed, increasing the time and complexity of the calculations.

### **C. Existing + Addition as a Newly Constructed Building**

In this compliance scenario, modeling the existing building and the addition as if they were a newly constructed building. This approach is used when changes to



the existing building are extensive. Demonstrating compliance can be difficult because all existing features must be brought up to current code.

### **9.3.2 Additions and Alterations Combined**

#### **9.3.2.1 Prescriptive Approach**

When a single-family building project that includes an addition and alterations uses the prescriptive approach to compliance, all prescriptive requirements must be met. The addition complies with the CF1R-ADD-01 prescriptive certificate of compliance.

Alterations to the existing building must also meet prescriptive requirements and be documented by a CF1R-ALT-02 prescriptive certificate of compliance for alterations.

#### **9.3.2.2 Performance Approach**

The performance approach to projects that include both an addition and alterations to an existing residential building is called “**Existing + Addition + Alterations.**” (See Section 9.5.2.) Projects can comply with or without the benefit of pre-construction third-party inspection and verification of existing conditions that are to be altered.

### **9.3.3 Alterations Only**

#### **9.3.3.1 Prescriptive**

Alterations may comply prescriptively by meeting all applicable requirements in §150.2(b), which are explained further in Section 9.4. Several prescriptive alteration requirements or exceptions are specific to conditions such as building climate zone.

It is important to note that the energy budget is based on prescriptive requirements and every applicable prescriptive requirement must be met; otherwise, the building must comply using the performance approach. However, if one or more proposed alterations do not comply prescriptively, other alterations must exceed prescriptive requirements for the project to comply based on the performance approach.

Under the prescriptive approach to alterations, the CF1R-ALT-02 prescriptive certificate of compliance is completed and submitted with the permit application. If any mandatory or prescriptive features require HERS verification (see Section 2.5, HERS Field Verification and Diagnostic Testing, of this manual), the certificate of compliance must be completed and registered online with a HERS provider (see Section 2.3 of this manual) before being submitted to the enforcement agency.

#### **9.3.3.2 Performance**

Alterations may comply using the performance approach by meeting the requirements in §150.2(b)2. This is explained in Section 9.5. The main options are:

1. **Existing plus alterations:** If multiple components or systems are being altered or if the proposed modification(s) exceed prescriptive requirements, then the existing + alterations performance approach can be used to make trade-offs.
2. **Compliance without third-party verification:** This option allows alterations to comply without third-party inspection to verify existing conditions being altered.
3. **Compliance with third-party verification:** This option allows for alterations to comply only with third-party inspection to verify existing conditions being altered.
4. **Existing plus alterations as a newly constructed building:** This option is the most difficult.

### 9.3.4 Wall Exceptions to Continuous Insulation

#### 9.3.4.1 Wall Extension

When an addition is built with a connection to an existing wood-framed wall, an extension to an existing wood-framed wall (Figure 9-1) is allowed to retain the existing dimensions (§150.2(a)1Ai or 150.2(a)1Biii). Retain the dimensions means two things: (1) if the existing wood-framed wall has no continuous insulation, the extended wall also does not require continuous insulation; and (2) the existing framing size may be kept.

This exception will typically apply to only one or two walls of an addition. Prescriptive compliance for the walls that meet the criteria will require R-15 cavity insulation if the existing framing is 2x4 or R-21 cavity insulation if the existing framing is 2x6 for the extended wall(s). The energy budget for performance compliance will match the prescriptive requirements.

#### 9.3.4.2 Existing Wall With Siding

Similar to a wall extension is a provision that applies to existing wood-framed walls of a previously unconditioned space. If the existing exterior siding (or cladding) of the structure is not being removed, and the space is converted to conditioned space, §150.2(a)1Aiii or 150.2(a)1Bvi requires only cavity insulation of R-15 in a 2x4 wall or R-21 in a 2x6 wall.

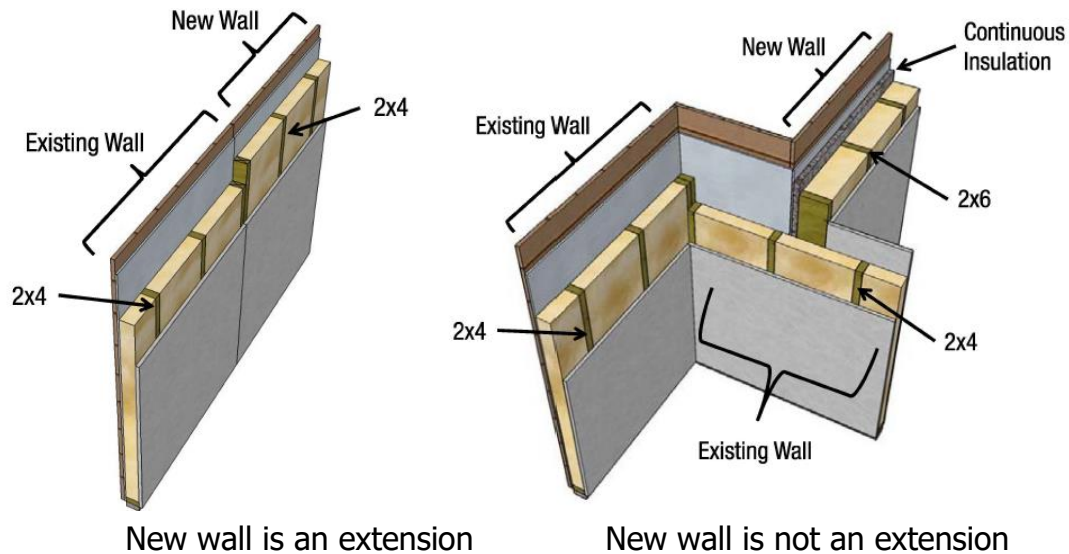
**Figure 9-1: Wall Extension**

### 9.3.5 Accessory Dwelling Units (ADUs)

The California Department of Housing and Community Development defines accessory dwelling units as:

an attached or detached residential dwelling unit which provides complete independent living facilities for one or more persons. An ADU shall include permanent provisions for living, sleeping, eating, cooking, and sanitation on the same parcel as the single-family dwelling is situated.





The 2022 Energy Code adds a new definition for junior accessory dwelling unit (JADU). A JADU is a dwelling unit that is no more than 500 square feet in size and contained entirely within an existing single-family building. A JADU includes a kitchen, a separate entrance from the main entrance to the building, and an interior entry to the main living area. A JADU may include separate sanitation facilities, or may share sanitation facilities with the existing single-family building.

State legislation that took effect on January 1, 2017, gave more flexibility to build ADUs, sometimes called “granny” or “in-law” units. For compliance, an ADU may be either an addition or a newly constructed building. See Figure 9-2 to determine the compliance requirements. Although the Energy Code that applies to the ADU may be the same as an addition, this may not be the same for other Parts of Title 24. Check with your local building department to confirm applicable requirements.

ADU compliance requirements are based on the associated Energy Code classification as either an addition or alteration to an existing residence or as a new building, as shown in Figure 9-2. An ADU may comply using any of the prescriptive or performance method options available for other residential additions or new buildings plus meeting applicable mandatory requirements.

1. If the ADU shares common walls with the existing dwelling unit and is newly constructed, some of the walls may be wall extensions (Section 9.3.4).
2. If the ADU shares no common walls with the existing dwelling unit (detached) and is converting an existing unconditioned structured into conditioned space, an exception to the requirement for continuous insulation is available for walls where existing exterior siding (or cladding) is not removed.
3. If the ADU shares common walls with the existing dwelling unit and is converting an attached unconditioned space into conditioned space, the existing walls of the new ADU may meet an exception to the requirement for continuous insulation if exterior siding is not removed.
4. If the ADU shares no common walls with the existing dwelling unit (detached) and is a new structure, this is a newly constructed residential building.

**Figure 9-2: ADU Types**

 <p>Addition: Converting existing unconditioned space, attached to existing home. Walls may qualify as "existing wall with siding." (See Section 9.3.4 for wall exceptions.)</p>	 <p>Addition: Converting existing unconditioned space, detached from existing home. Walls may qualify as "existing wall with siding." (See Section 9.3.4 for wall exceptions.)</p>
 <p>Addition: Newly constructed, attached to existing home. One or more walls may qualify as wall extensions. (See Section 9.3.4 for wall exceptions.)</p>	 <p>Newly Constructed Building: Newly constructed and detached from existing home.</p>

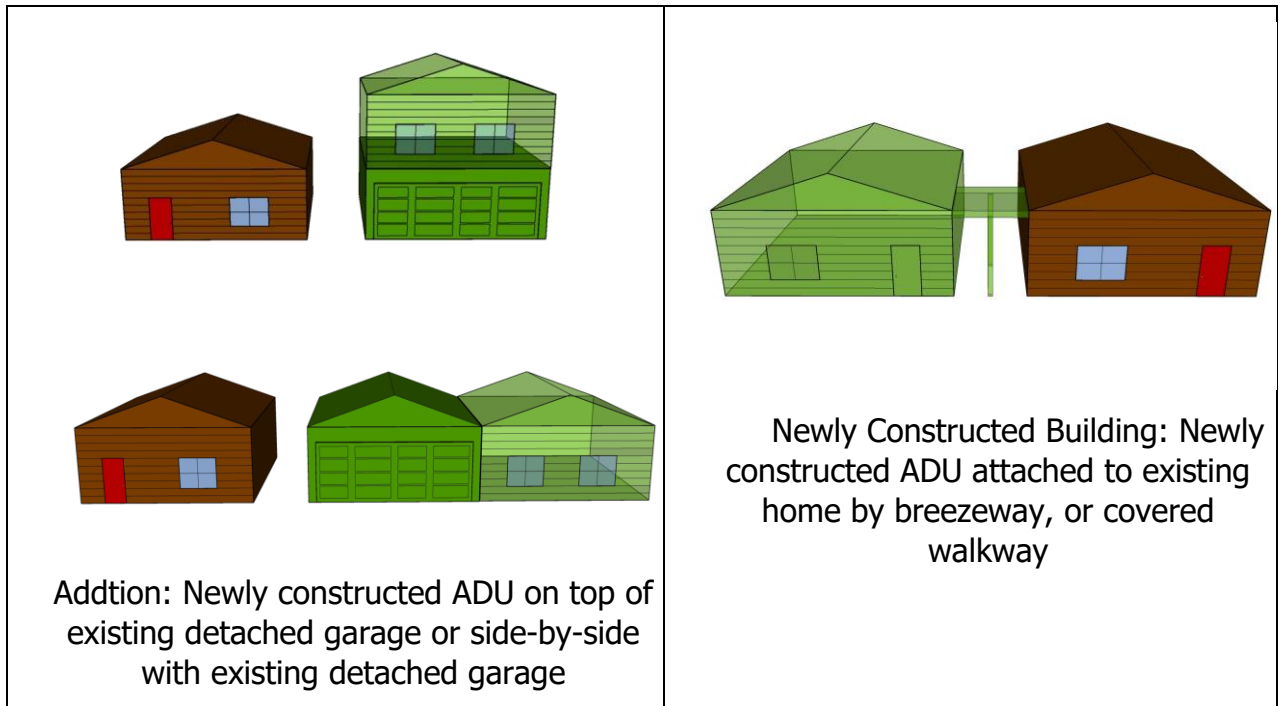

## 1. HVAC

When adding an attached ADU to an existing home, the Mechanical Code does not allow return air from one dwelling unit to be discharged into another dwelling unit through a shared heating or cooling system. Systems without ducts are an option.

A system serving an ADU must have its own thermostat. Heating systems must be capable of maintaining 68 °F at a point three feet above the floor and two feet from the exterior walls in habitable rooms. Heating and cooling load calculations will need to be provided per Title 24, Part 6, Section 150.0(h) to verify that any existing and/or new system is properly sized,

Any addition that adds a new dwelling unit must meet all applicable IAQ ventilation requirements of Sections 150.0(o)1C, except for additions that are JADUs (defined above). A detached ADU must meet all applicable IAQ ventilation requirements of Sections 150.0(o)1C. An attached ADU must also meet all requirements if the dwelling units do not share a floor or ceiling. The whole house ventilation airflow is to be based on the square footage of the new dwelling unit.

Local exhaust for bathrooms and kitchens is required for any addition. See Table 9-7 in Section 9.4.2 for a more detailed summary of prescriptive HVAC system requirements for additions.

## 2. Photovoltaics (PV)

Solar electricity generated by photovoltaics (PV) is not required if the ADU is an addition. PV is required for detached, newly constructed ADUs.

---

### Example 9-4:

**Question:**

An existing single-story residence has a 600 ft<sup>2</sup> attached unconditioned storage room that the owner plans to turn into an accessory dwelling unit. The existing uninsulated walls have 2x6 wood framing, and the owner plans to keep the existing exterior siding. For prescriptive compliance, what wall insulation is required in the proposed ADU?

**Answer:**

The proposed ADU is considered an addition for Title 24, Part 6. The existing 2x6 walls can be insulated with R-21 cavity insulation (§150.2[a]1Bvi) for prescriptive compliance. Continuous insulation is not required for these walls.

**Example 9-5:****Question:**

Can the ADU in the previous example get energy compliance credit using HERS verification of existing conditions for performance method compliance?

**Answer:**

No. Existing walls in newly conditioned spaces are not eligible for the HERS verification of existing conditions.

**Example 9-6:****Question:**

In the ADU in the previous example, is solar electricity generated by PV required for prescriptive or performance method compliance?

**Answer:**

No, PV is not required for Title 24 energy compliance for additions using any compliance approach.

**Example 9-7:****Question:**

The existing residence in the previous example has a ducted forced-air furnace enough heating capacity to heat the existing residence and the new ADU. Is this allowed for code compliance?

**Answer:**

No. The California Mechanical Code does not allow return air from an existing forced-air system to be discharged into another dwelling unit through the heating or cooling system. Therefore, the existing ducted furnace may not serve the existing home and the proposed ADU.

**Example 9-7a:**

Question: When modeling a conversion of an existing garage to an accessory dwelling unit (ADU), and also making an addition to the existing house, can this be modeled together using the existing plus addition plus alteration approach?

Answer: Yes. In this scenario, the existing home, addition, and ADU must be modeled as separate zones. Also, if the existing home has natural gas connected to it, the project must be modeled with natural gas being available.

**Example 9-7b:**

Question: When converting an existing garage into an ADU in a high-rise residential building, do the high-rise residential Energy Code requirements apply to the ADU?

Answer: Yes. The building occupancy type determines the compliance approach. If there are four or more habitable stories in the building, the ADU must comply with high-rise residential Energy Code requirements.

**Example 9-7c:**

Question: When converting existing conditioned space, like a conditioned basement, into an ADU or junior ADU, is this an addition?

Answer: No. This is an alteration. Energy Code requirements may be triggered if altering a component which is covered by the Energy Code. Some examples of alterations that are covered by the Energy Code are newly installed water heaters or mini-split HVAC systems, lighting upgrades, changes to the building envelope, etc.

---

## 9.4 Prescriptive Approach and Mandatory Requirements

The prescriptive requirements apply to additions in the same way they apply to new buildings and must be documented on the CF1R-ADD-01 or CF1R-NCB-01 Form.

Except as noted, all applicable prescriptive requirements for additions must be met when using the prescriptive approach. Otherwise, the building must comply using the performance approach.

For prescriptive additions, a certificate of compliance (CF1R-ADD-01 or CF1R-NCB-01) form must be completed and submitted for permit. If any mandatory or prescriptive features require HERS verification or testing or both, the certificate of compliance for the project must be completed and registered online with a HERS Provider before submittal to the enforcement agency. Refer to Section 2.2.2 and Section 2.5.

### 9.4.1 Prescriptive Additions

There are three prescriptive paths available for additions based on the total conditioned floor area (CFA) of the addition. The total CFA of the addition may include floor areas representing several physically separate additions to the building under the same permit. Table 9-2 through Table 9-6 summarize the key features of

the prescriptive envelope requirements for the three prescriptive addition options in §150.2(a)1.

The prescriptive requirements for additions are listed in §150.2(a)1. Unless noted below, the newly constructed building prescriptive requirements contained in §150.1(c) also apply.

**1. Additions  $\leq$  400 ft<sup>2</sup>:**

1. Total glazing area up to 75 ft<sup>2</sup> or 30 percent of the conditioned floor area, whichever is greater.
2. Total glazing area maximum for west-facing glazing is 60 ft<sup>2</sup> or 5 percent in Climate Zones 2, 4, and 6-15.
3. QII does not apply.
4. Rafter roof insulation of R-22.
5. Ceiling insulation of R-38 in Climate Zones 1,2,4 and 8-16, or R-30 in Climate Zones 3 and 5-7.
6. Radiant barrier in Climate Zones 2-15.
7. Extensions of existing wood-framed walls (Figure 9-1) may retain the dimensions of the existing walls and require the following cavity insulation:
  - a. In 2x4 wood-frame walls, insulation shall be R-15.
  - b. In 2x6 or greater wood-frame walls, insulation shall be R-21.
8. Existing wood-framed walls where existing exterior siding (or cladding) will not be removed, do not need continuous insulation, and require only cavity insulation:
  - a. In 2x4 wood-framed walls, insulation shall be R-15.
  - b. In 2x6 or greater wood-framed walls, insulation shall be R-21.

**B. Additions  $>$  400 ft<sup>2</sup> and  $\leq$  700 ft<sup>2</sup>:**

1. Total glazing area up to 120 ft<sup>2</sup> or 25 percent of the conditioned floor area.
2. Total glazing area maximum for west-facing glazing is 60 ft<sup>2</sup> or 5 percent in Climate Zones 2, 4, and 6-15.
3. QII does not apply.
4. Rafter roof insulation of R-22.
5. Ceiling insulation of R-38 in Climate Zones 1,2,4, and 8-16 or R-30 in Climate Zones 3 and 5-7.
6. Radiant barrier in Climate Zones 2-15.



7. Extensions of existing wood-framed walls may retain the dimensions of the existing walls and require the following cavity insulation:
  - a. In 2x4 wood-framed walls, insulation shall be R-15.
  - b. In 2x6 or greater wood-framed walls, insulation shall be R-21.
8. Existing wood-framed walls, where existing exterior siding (or cladding) will not be removed, do not need continuous insulation, and require only cavity insulation:
  - a. In 2x4 wood-framed walls, insulation shall be R-15.
  - b. In 2x6 or greater wood-framed walls, insulation shall be R-21.

**C. Additions > 700 ft<sup>2</sup>:**

1. Total glazing area up to 175 ft<sup>2</sup> or 20 percent of the conditioned floor area, whichever is greater.
2. Total glazing area maximum for west-facing glazing is 70 ft<sup>2</sup> or 5 percent in Climate Zones 2, 4, and 6-15.
3. Extensions of existing wood-framed walls may retain the dimensions of the existing walls and require the following cavity insulation:
  - a. In 2x4 wood-framed walls, insulation shall be R-15.
  - b. In 2x6 or greater wood-framed walls, insulation shall be R-21.
4. Existing wood-framed walls, where existing exterior siding (or cladding) will not be removed, do not need continuous insulation, and require only cavity insulation:
  - a. In 2x4 wood-framed walls, insulation shall be R-15.
  - b. In 2x6 or greater wood-framed walls, insulation shall be R-21.
5. QII applies to the addition.
6. When an addition greater than 700 ft<sup>2</sup> is an existing unconditioned space converted to conditioned space, the QII requirements do not include:
  - a. Window and door header insulation.
  - b. Air sealing if the existing air barrier is not removed or replaced.

**Figure 9-3: Prescriptive Addition Envelope Requirements**

To provide consistency with existing wall alignment, extensions of the existing wall into the addition shall have R-15 for 2x4 walls

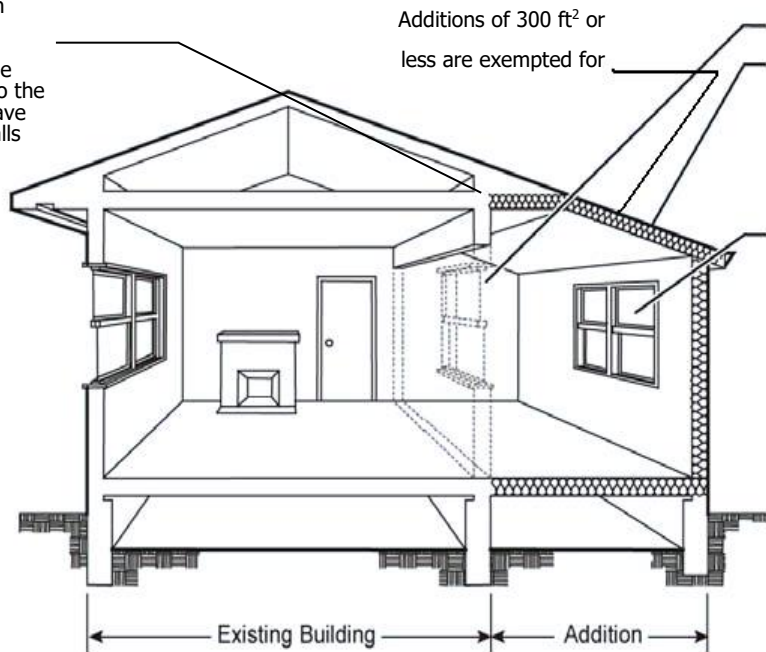

Removed wall and window not included in the calculation.

Insulation requirements from Prescriptive table; unless addition is 700 ft<sup>2</sup> or less, then meet mandatory minimum roof/ceiling insulation

Fenestration area is limited based on the size of the addition:

- For additions < 400 ft<sup>2</sup>: 75 ft<sup>2</sup> or 30% of CFA – whichever is greater -- for total glazing area; and 60 ft<sup>2</sup> for west-facing glazing.
- For additions > 400 ft<sup>2</sup> and < 700 ft<sup>2</sup>: 120 ft<sup>2</sup> or 25% of CFA – whichever is greater -- for total glazing area; and 60 ft<sup>2</sup> for west-facing glazing.
- For additions > 700 ft<sup>2</sup>: 175 ft<sup>2</sup> or 20% of CFA – whichever is greater -- for total glazing area; and 70 ft<sup>2</sup> or 5% of CFA –

**Example 9-8**

**Question:**

I am retrofitting an existing home that includes an 800 ft<sup>2</sup> addition. Part of this addition includes converting a 400 ft<sup>2</sup> unconditioned garage to conditioned space and adding a 400 ft<sup>2</sup> bedroom above the garage. If complying prescriptively, is QII required for this addition?

**Answer:**

Yes. Because this addition, including the conversion of the garage, is greater than 700 ft<sup>2</sup>, QII is prescriptively required. If the existing walls of the garage are remaining and the exterior cladding is not being removed, the QII insulation requirements for window and door headers in the garage walls and QII air-sealing requirements are not required. For all new walls and walls that are being replaced, all aspects of QII must be met. If the performance method is used for compliance, the QII requirements can be traded off with other efficiency features to meet compliance. The prescriptive wall insulation requirements for existing wood framed walls in the garage are R-15 in 2x4 framing and R-21 in 2x6 framing.

**Example 9-9**

**Question:**

A small addition of 75 ft<sup>2</sup> is planned for a house in climate zone 7. An existing porch is being enclosed by extending the existing 2x4 wood-framed walls. The existing heating and air-conditioning system will serve the new conditioned space, including an extension of less than 25 linear feet of new ducts. The contractor wants to follow the prescriptive requirements. What requirements apply?

**Answer:**

Because the addition is smaller than 400 ft<sup>2</sup>, the total fenestration area is limited to a maximum of 75 ft<sup>2</sup>, and west-facing fenestration area is limited to 60 ft<sup>2</sup>. The fenestration must meet the prescriptive U-factor and SHGC requirements of Table 150.1-A, which are a maximum U-factor of 0.30 and a maximum SHGC of 0.23 in climate zone 7.

In climate zone 7, for an addition of this size, insulation requirements are R-30 ceiling insulation with radiant barrier in a ventilated attic, and R-19 floor insulation. The new 2x4 walls that are extensions of existing walls (Figure 9-1), require only R-15 cavity insulation. Any walls that are not extensions must have a maximum 0.065 U-factor. This can be achieved with a 2x4 wood-framed wall with R-15 cavity and R-4 continuous insulation. Since the addition is less than 300 ft<sup>2</sup> there is no cool roof requirement.

Since existing heating and cooling equipment is used, that equipment does not have to meet the mandatory equipment efficiency requirements. Duct sealing requirements apply regardless of the length of ductwork extended to serve the addition. The existing duct system must be sealed and tested to have no more than 10 percent total leakage or 7 percent leakage to outside. Duct insulation requirements apply to any new ducts, which is R-6.0 minimum in unconditioned space, and the duct system must be sealed (Exception 4 to §150.2(a)). All other applicable mandatory requirements in §150.0(m) must be met.

**Example 9-10**

**Question:**

If I remove a window from the existing house and reuse this window in an addition to that house, does the relocated window have to meet the prescriptive requirements?

**Answer:**

Yes, if using prescriptive compliance, in which case the relocated window must be treated as a new window and must meet the U-factor and SHGC requirements of §150.1(c)3. If you use this existing window in the addition, you must use the actual or default U-factor and SHGC of the window in showing compliance. Therefore, meeting the prescriptive requirements may not be possible, and performance compliance may be the only option. Window certification and labeling requirements of §110.6(a) do not apply to existing used windows.

Relocated windows must also meet the maximum area-weighted average U-factor in §150.0(q) with the EXCEPTION of up to 10 ft<sup>2</sup> or 0.5 percent of conditioned floor area, whichever is greater.

---

**Example 9-11****Question:**

For an addition alone, do the refrigerant charge requirements in §150.1(c)7A and fan airflow and watt draw measurements in §150.0(m)13 need to be met for existing air conditioners serving an addition?

**Answer:**

If existing equipment is used to serve the addition, the refrigerant charge, airflow, and watt draw requirements do not need to be met as specified by Exception 3 to §150.2(a). However, if the existing duct system is extended to serve the addition it must meet the duct insulation requirements and duct sealing requirements must be met (Exception 4 to §150.2(a)). . New ducts in unconditioned space also shall meet the prescriptive duct insulation requirements per §150.2(b)1Di.

If a new system is installed to serve the addition, it must meet all the requirements for space conditioning in a new home which includes prescriptive refrigerant charge verification in Climate Zones 2 and 8-15 and mandatory fan airflow and watt draw testing in all climate zones. The one exception is that prescriptively the new systems may be either a heat pump or gas heating system.

---

**Table 9-2: Envelope Roof/Ceiling Requirements for Prescriptive Additions**

Component	Additions ≤ 400 ft <sup>2</sup>	Additions > 400 and ≤700 ft <sup>2</sup>	Additions > 700 ft <sup>2</sup>
Roof/Ceiling Insulation	CZ 1, 2, 4, 8-16: R-38 CZ 3, 5-7: R-30	Same as ≤ 400 ft <sup>2</sup>	Option B or C [C = require ducts and air handler to be in conditioned space] (see Table 9-3 below).
Roof Products (Cool Roof)	Steep Slope (≥2:12): CZ10-15: Reflectance = 0.20 and Emittance = 0.75; or SRI = 16 Low-Sloped (<2:12): CZ 13&15: Reflectance = 0.63 and Emittance = 0.75; or SRI = 75 Exception: Additions ≤ 300 ft <sup>2</sup> exempt from cool roof requirements	Same as ≤ 400 ft <sup>2</sup>	Steep-Sloped (≥2:12): CZ10-15: Reflectance = 0.20 and Emittance = 0.75; or SRI = 16 Low-Sloped (<2:12) CZ 13&15: Reflectance = 0.63 and Emittance = 0.75; or SRI = 75
Radiant barrier above attic	CZ 2-15: Radiant barrier above attic spaces	Same as ≤ 400 ft <sup>2</sup>	CZ 2-15: Radiant barrier above attic spaces except when complying with Option B (see §150.1(c)2)

**Figure 9-4: Ventilated Attic Prescriptive Compliance Choices for Additions >700 ft<sup>2</sup>**

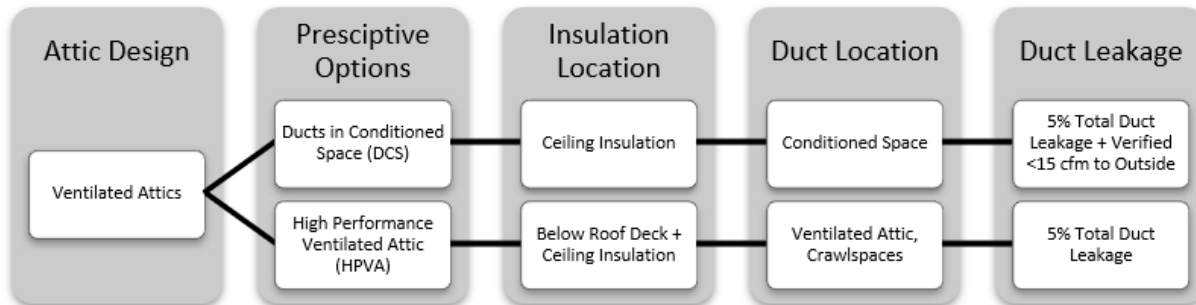

**Table 9-3: Roof and Ceiling Requirements for Prescriptive Additions**

Component	Option B	Option C (CZ 4, 8-16)
Roof Deck Insulation	Below-deck insulation CZ 4, 8-16: R-19	No roof deck insulation required
Radiant Barrier	CZ 2-3, 5-7	CZ 2-15
Roofing	Tile roof or other product with an air space	Tile roof or other product with an air space
Ceiling Insulation	CZ 1, 2, 4, 8-16: R-38 CZ 3, 5-7: R-30	CZ 2-10: R-30 CZ 1, 11-16: R-38
Duct and Air Handler Location	Attic	Conditioned space

**Table 9-4: Envelope Door and Glazing Requirements for Prescriptive Additions**

Component	Additions ≤ 400 ft <sup>2</sup>	Additions > 400 and ≤ 700 ft <sup>2</sup>	Additions > 700 ft <sup>2</sup>
Allowable total glazing area	Up to 75 ft <sup>2</sup> or 30% of conditioned floor area, whichever is greater	Up to 120 ft <sup>2</sup> or 25% of conditioned floor area, whichever is greater	Up to 175 ft <sup>2</sup> or 20% of conditioned floor area, whichever is greater
Allowable west-facing glazing area: CZ 2, 4, 6-15	Up to 60 ft <sup>2</sup>	Up to 60 ft <sup>2</sup>	The greater of 70 ft <sup>2</sup> or 5% of conditioned floor area in CZ 2, 4, 6-15
Glazing U-factor & SHGC <sup>1</sup>	All CZs: U = 0.30 CZ 2, 4 & 6-15: SHGC = 0.23	All CZs: U = 0.30 CZ 2, 4 & 6-15: SHGC = 0.23	All CZs: U = 0.30 CZ 2, 4 & 6-15: SHGC = 0.23
Opaque door U-factor	U = 0.20	U = 0.20	U = 0.20

1. See §§150.0(q) and 150.1(c)3 for new and replaced window and skylight exceptions.

**Table 9-5: Envelope Wall/Floor Insulation Requirements for Prescriptive Additions**

Component	Additions ≤ 400 ft <sup>2</sup>	Additions > 400 and ≤ 700 ft <sup>2</sup>	Additions > 700 ft <sup>2</sup>
Exterior framed wall <sup>1</sup> insulation	CZ 1-5, 8-16: U = 0.048 CZ 6-7: U = 0.065	Same as ≤ 400 ft <sup>2</sup>	Same as ≤ 400 ft <sup>2</sup>
Extension of existing wood-framed wall Or Existing wood-framed wall with exterior siding (or cladding) to remain	R-15 in 2x4 wood framing R-21 in 2x6 wood framing	Same as ≤ 400 ft <sup>2</sup>	Same as ≤ 400 ft <sup>2</sup>
Raised floor <sup>1</sup> insulation	All CZs: R-19 or U = 0.037	Same as ≤ 400 ft <sup>2</sup>	Same as ≤ 400 ft <sup>2</sup>
Slab floor <sup>1</sup> perimeter insulation	CZ 1-15: No requirement CZ1: R-7 or U = 0.58	Same as ≤ 400 ft <sup>2</sup>	Same as ≤ 400 ft <sup>2</sup>

1. See Table 150.1-A and 150.1-B for requirements for non-framed walls including mass walls

2. R-values refer to wood framing, and U-factors refer to metal framing.

**Table 9-6: QII Requirements for Prescriptive Additions**

<b>Component</b>	<b>Additions <math>\leq</math> 400 ft<sup>2</sup></b>	<b>Additions &gt; 400 and <math>\leq</math> 700 ft<sup>2</sup></b>	<b>Additions &gt; 700 ft<sup>2</sup></b>
New structure	No requirement	Same as $\leq$ 400 ft <sup>2</sup>	All CZs: Required (Does not apply to any altered spaces)
Converting unconditioned to conditioned space	No requirement	Same as $\leq$ 400 ft <sup>2</sup>	Same as above except: Window and door header insulation Air sealing if the existing air barrier is not removed or replaced

**Table 9-7: HVAC Requirements for Prescriptive Additions**

<b>Component</b>	<b>Additions <math>\leq</math> 400 ft<sup>2</sup></b>	<b>Additions &gt; 400 and <math>\leq</math> 700 ft</b>	<b>Additions &gt; 700 ft<sup>2</sup></b>
Ventilation cooling <sup>1</sup> (whole-house fan)	No Requirement	Same requirements as $\leq$ 400 ft <sup>2</sup>	Additions $\leq$ 1000 ft <sup>2</sup> – no requirement Additions > 1,000 ft <sup>2</sup> : CZ 8-14 - required
Adding new space conditioning system(s)	All prescriptive requirements	Same requirements as $\leq$ 400 ft <sup>2</sup>	All except requirement for ducts in conditioned space <sup>2</sup>
Replacing existing space conditioning system(s)	All prescriptive requirements	Same requirements as $\leq$ 400 ft <sup>2</sup>	All except requirement for ducts in conditioned space <sup>2</sup>
Adding all new complete duct system(s)	All prescriptive requirements	Same requirements as $\leq$ 400 ft <sup>2</sup>	All except requirement for ducts in conditioned space <sup>2</sup>
Extending existing duct system(s)	All duct insulation, duct system sealing, and HERS verification	Same requirements as $\leq$ 400 ft <sup>2</sup>	All duct insulation, duct system sealing, and HERS verification, Except requirements for ducts in conditioned space <sup>2</sup>

Source: California Energy Commission

1. (Note: also, mandatory mechanical ventilation per ASHRAE 62.2 with HERS verification for additions > 1,000 ft<sup>2</sup>)
2. For more information about ducts in conditioned space, see Section 3.5.3.5.

### 9.4.2 Water Heating System

If an addition increases the number of water heaters serving a dwelling unit, the addition can comply prescriptively if one of the conditions contained in §150.2(a)1Di-iv are met.

For a complete list of options, see Chapter 5.

### 9.4.3 Alterations – Prescriptive/Mandatory Requirements

This section provides a road map and a few relevant summaries that identify the requirements unique to alterations. Envelope, mechanical, and water-heating system alterations must meet all applicable mandatory requirements and comply with either the prescriptive or performance approach. If a building does not meet all applicable prescriptive requirements, then the performance method using of approved compliance software is the alternative. This section describes the mandatory requirements for single-family residential buildings as they apply to additions and alterations. More information on the mandatory requirements can be found in Chapters 3, 4, 5, and 6.

Residential lighting alterations need to meet applicable mandatory requirements. There are no prescriptive lighting requirements in residential buildings.

Although alterations must meet many of the same prescriptive requirements for newly constructed buildings and additions, there are several exceptions or special allowances for certain types of alterations.

### 9.4.4 Envelope Alterations

This section summarizes requirements for many typical residential envelope alterations.

**Table 9-8: Single-family Alterations Summary of Mandatory and Prescriptive Requirements**

<b>Envelope Alteration Type</b>	<b>Applicable Mandatory Requirements<sup>1</sup></b>	<b>Summary of Relevant Prescriptive Requirements<sup>2</sup></b>	<b>Exception(s) to the Prescriptive Requirements</b>
Altered Ceiling	Ceiling w/ attic and roof rafters: R-19, U=0.054 §150.0(a)	R-49 (U=0.20) attic insulation: CZ 1-4, 6, 8-16  Recessed can lights covered with insulation to the same depth as the rest of the ceiling: CZ 1-4, 8-16  Air sealing: CZ 2,4,8-16	1. R-38 existing attic insulation.  2. Asbestos or knob and tube wiring in the attic.  3. Attic space is shared with another dwelling unit which does not have an altered ceiling.  The above conditions exempt a project from all the



<b>Envelope Alteration Type</b>	<b>Applicable Mandatory Requirements<sup>1</sup></b>	<b>Summary of Relevant Prescriptive Requirements<sup>2</sup></b>	<b>Exception(s) to the Prescriptive Requirements</b>
		Min. attic ventilation: all CZs §150.2(b)1j	prescriptive requirements. Other exceptions apply to individual requirements, see Section 9.4.3.2 for further details.
Altered rafter roof	R-19, U=0.054 §150.0(a)	N/A	N/A
Adding exterior framed wall insulation	In 2x4 framing: R-13, U=0.102 In 2x6 framing: R-20, U=0.071 Exception: 2x4 framing already insulated to R-11 or greater per §150.0(c)1	N/A	N/A
Mass/concrete walls	See §150.1(c) for applicable climate zone	N/A	N/A
Replacing > 50% of existing <u>steep-sloped (≥2:12)</u> roof surface, including adding a new surface layer on top of existing exterior surface	§110.8(i)	<u>Cool Roof Requirements</u> CZ <u>4, 8 - 15</u> : Reflect.≥0.20 and Emittance≥0.75; or SRI≥16 §150.2(b)1ii	(a) Air space 1.0" between roof deck and bottom of roofing product (b) Profile ratio of rise to width of 1:5 for >50% width of roofing product. (c) Existing ducts in attic insulated and sealed per §150.1(c)9.

Envelope Alteration Type	Applicable Mandatory Requirements <sup>1</sup>	Summary of Relevant Prescriptive Requirements <sup>2</sup>	Exception(s) to the Prescriptive Requirements
			<p>(ad) Roof has <math>\geq</math> R-38 ceiling insulation.</p> <p>(be) Roof has a radiant barrier per §150.1(c)2 (not over spaced sheathing).</p> <p>(c) In CZ 2, 4, 9, 10, 12, &amp; 14 no ducts in attic.</p> <p>(d) <math>\geq</math>R-2.0 insulation above roof deck</p> <p>(e) Roof area covered by building integrated PV or solar thermal panels.</p> <p>(f) Roof constructions with a weight <math>\geq</math>25 lbs/ft<sup>2</sup>.</p>
<p>Replacing &gt; 50% of existing low-sloped (&lt;2:12) roof surface, including adding a new surface layer on top of existing exterior surface</p>	<p>§110.8(i)</p>	<p>Cool Roof Requirements                      CZ 4,6 - 15:                      Reflectance <math>\geq</math> 0.63;                      Emittance <math>\geq</math> 0.75                      §150.2(b)1Iiia</p>	<p>(a) There are no ducts in the attic.</p> <p>(b) Reflectance and Roof Deck Insulation R-value in Table 150.2-A are met</p> <p>(c) Roof area covered by building integrated PV or solar thermal panels.</p>

<b>Envelope Alteration Type</b>	<b>Applicable Mandatory Requirements<sup>1</sup></b>	<b>Summary of Relevant Prescriptive Requirements<sup>2</sup></b>	<b>Exception(s) to the Prescriptive Requirements</b>
			(d) Roof constructions with a weight $\geq 25$ lbs/ft <sup>2</sup> .
Adding or replacing skylight <sup>3</sup>	Weighted average U-factor $\leq 0.58$ Exemption: Up to 20 ft <sup>2</sup> or 0.5% of conditioned floor area, whichever is greater, is exempt from the U-factor requirement of §150.0(q)	Must not exceed 20% total (all CZs) and 5% west fenestration area (CZ 2, 4, 6-15) with a U-factor $\leq 0.30$ (all CZs); in CZ2, 4 & 6-15: SHGC $\leq 0.23$ §150.2(b)1A	Up to 75 ft <sup>2</sup> need not meet total or west-facing fenestration area per §150.2(b)1A Exception 1  Replacement skylights up to 16 ft <sup>2</sup> with a U $\leq 0.55$ and SHGC $\leq 0.30$ and not meet total fenestration and west-facing area requirements per §150.2(b)1A Exception 2
Adding raised floor insulation	R-19 or equivalent U-factor  Exception: Floors over controlled ventilation or unvented crawlspaces per §150.0(d)	N/A	N/A
Replacing vertical fenestration <sup>3</sup> (altered glazing)	Weighted average U-factor $\leq 0.58$ Exemption: Up to 10 ft <sup>2</sup> or 0.5% of conditioned floor area, whichever is greater, is exempt from the U-factor	Must not exceed 20% total (all CZs) and 5% west fenestration area (CZ 2, 4, 6-15) with a U-factor $\leq 0.30$ (all CZs); in CZ2, 4 & 6-15: SHGC $\leq 0.23$ §150.2(b)1A	Up to 75 ft <sup>2</sup> need not meet total or west-facing fenestration area per §150.2(b)1A Exception 1  Replacement skylights up to 16 ft <sup>2</sup> with a U $\leq 0.55$

<b>Envelope Alteration Type</b>	<b>Applicable Mandatory Requirements<sup>1</sup></b>	<b>Summary of Relevant Prescriptive Requirements<sup>2</sup></b>	<b>Exception(s) to the Prescriptive Requirements</b>
	requirement of §150.0(q)		and SHGC ≤0.30 and not meet total fenestration and west-facing area requirements per §150.2(b)1A Exception 2
Adding vertical fenestration <sup>3</sup> (new glazing) and greenhouse	Weighted average U-factor ≤0.58  Exemption: Up to 10 ft <sup>2</sup> or 0.5% of conditioned floor area, whichever is greater, is exempt from the U-factor requirement of §150.0(q)	Must not exceed 20% total (all CZs) and 5% west fenestration area (CZ 2, 4, 6-15) with a U-factor ≤ 0.30 (all CZs); in CZ2, 4 & 6-15: SHGC = ≤ 0.23 §150.2(b)1A	Up to 75 ft <sup>2</sup> need not meet total or west-facing fenestration area per §150.2(b)1A Exception 1  Added greenhouse must either meet the maximum or weighted average U-factor of 0.58 or up to 10ft <sup>2</sup> or 0.5% of CFA whichever is greater as per Exception 1 to §150.0(q)1

Source: California Energy Commission

1. Alterations must comply with all applicable mandatory measures in §110.0 and §150.0 of the Energy Standards as explained in Chapters 3, 4, 5 and 6 of this manual, except as noted in §150.2(b).
2. Several prescriptive measures are climate zone (CZ) specific.
3. Replacement fenestration may include fenestration that is located in the same existing wall or roof in which the same or larger area of existing fenestration is being removed. This is labeled as “altered.” Any new fenestration area that increases the total net area of fenestration in any existing wall or roof is labeled as “new.”

#### **9.4.4.1 Replacing the Roof Surface or Roof Sheathing (Partial or Entire Replacement)**

If 50 percent or more of the roof surface of an existing building is being altered, either by replacing the existing roof or adding a new surface lay on top of the existing surface, the following requirement must be met.

##### **1. Steep-Sloped Roofs ( $\geq$ 2:12) [150.2(b)1Ii]**

Steep-sloped roofs will need to meet a cool roof product requirement when 50 percent or more of the roof surface of an existing building is being replaced. In climate zones 4, and 8 through 15, the new roof products for the replaced steep-sloped roofing area shall have a minimum aged solar reflectance of 0.20 and minimum thermal emittance of 0.75, or a minimum SRI of 16. These requirements apply unless one of the following is present per Exception 1 to §150.2(b)1Ii:

1. Building has at least R-38 insulation or ceiling assemblies with maximum U-factor of 0.025.
2. Roof of attic spaces has a radiant barrier (not installed directly above spaced sheathing) according to §150.1(c)2.
3. There are no ducts in the attic space in climate zones 2, 4, 9, 10, 12 and 14.
4. Buildings with R-2.0 or greater continuous insulation above or below the roof deck.

Exception 2 to Section 150.2(b)1Ii exempts roof areas covered by building integrated photovoltaic panels or building integrated solar thermal panels from meeting the roofing product requirements.

Exception 3 to Section 150.2(b)1Ii exempts roof constructions with a weight of at least 25 pounds per square foot from meeting the roofing product requirements.

##### **2. Low-Sloped Roofs ( $<$ 2:12) [150.2(b)1Iiia]**

Low-sloped roofs will need to meet a cool roof product requirement as well as a roof insulation requirement when 50 percent or more of the roof surface of an existing building is being replaced.

In climate zones 4, and 6 through 15, the new roof products for the replaced low-sloped roofing area shall have a minimum aged solar reflectance of 0.63 and minimum thermal emittance of 0.75, or a minimum SRI of 75 per §150.2(b)1Iiia.

Exception 1 to §150.2(b)1Iiia allows the aged solar reflectance to be traded off by adding insulation at the roof deck as specified in Table 150.2-B of the Energy Code.

**Table 9-9: Aged Solar Reflectance Insulation Trade Off**

<b>Minimum Aged Solar Reflectance</b>	<b>Roof Deck Continuous Insulation R-value Climate Zones 6-7</b>	<b>Roof Deck Continuous Insulation R-value Climate Zones 2, 4, 8-15</b>
0.60	R-2	R-16
0.55	R-4	R-18
0.50	R-6	R-20
0.45	R-8	R-22
No requirement	R-10	R-24

Source: California Energy Commission

Exception 2 to Section 150.2(b)1Iiia exempts roof areas covered by building integrated photovoltaic panels or building integrated solar thermal panels from meeting the roofing product requirements

Exception 3 to Section 150.2(b)1Iiia exempts roof constructions with a weight of at least 25 pounds per square foot from meeting the roofing product requirements.

In addition to the roofing product requirements, low-sloped roofs in climate zones 1, 2, 4, and 8 through 16, shall be insulated to meet either continuous insulation of R-14 or a roof assembly U-factor of 0.039 per §150.2(b)1Iiib. There are some exceptions to the insulation requirements.

Exception 1 to Section 150.2(b)1Iiib exempts existing roofs with R-10 or greater continuous insulation above or below the roof deck.

Exception 2 to Section 150.2(b)1Iiib exempts existing roofs in climate zones 1, 2, 4, and 8 through 10 with an assembly U-factor of 0.056 or less or that are insulated with at least R-19 insulation between the roof rafters and in contact with the roof deck.

Exception 3 to Section 150.2(b)1Iiib allows the continuous insulation requirements to be reduced to R-4 when meeting either of the following conditions:

1. Mechanical equipment located on the roof will not be temporarily disconnected and lifted as part of the roof replacement. And the addition of insulation required would reduce the height from the roof surface to the top of the base flashing to less than what is required by the manufacturer’s installation instructions as per the California Residential Code Section R900
2. Replaced roofing abuts sidewall or parapet walls and the addition of insulation required would reduce the height from the roof surface to the top of the base flashing to less than what is required by the manufacturer’s

installation instructions as per California Residential Code Section R900, when all the following conditions apply:

- a. The sidewall or parapet walls are finished with an exterior cladding material other than the roof covering membrane material.
- c. The sidewall or parapet walls have exterior cladding material that must be removed to install the new roof covering membrane to maintain the minimum base flashing height.
- c. The ratio of the replaced roof area to the linear dimension of affected sidewall or parapet walls is less than 25 square feet per linear foot.

Exception 4 to Section 150.2(b)1Iiib allows the continuous insulation requirements to be reduced where increasing the thickness of above deck insulation would reduce the flashing around an existing exterior wall opening below what is permitted by the fenestration or door manufacturer's installation instructions, or registered design professionals approved flashing design, as per the California Residential Code Section R703.4, or by California Residential Code Section R905.2.8.3.

Exception 5 to Section 150.2(b)1Biib allows tapered insulation with lower thermal resistance at the drains and other low points to be used, provided that the thickness of insulation is increased at the high points of the roof so that the average thermal resistance equals or exceeds the required value.

### **3. Roofing Products: Cool Roof**

Cool roofs are not just white roofs but are products (tile, asphalt shingles, etc.) designed to reflect much of the sun's radiant energy back into space instead of transferring it as heat into the building below. The two basic characteristics that determine the performance of a cool roof are solar reflectance and thermal emittance. These roofing products must be certified by the Cool Roof Rating Council ([www.coolroofs.org](http://www.coolroofs.org)) per §§10-113 and 110.8(i).

A cool roof requires the roofing product manufacturer to test for solar reflectance and thermal emittance and be listed in the Cool Roof Rating Councils (CRRC) Rated Product Directory. Figure 9-5 is an example of an approved CRRC product label.

**Figure 9-5: CRRC Product Label and Information**

	<u>Initial</u>	<u>Weathered</u>	
	Solar Reflectance	0.00	Pending
	Thermal Emittance	0.00	Pending
	Rated Product ID Number	-----	
	Licensed Seller ID Number	-----	
	Classification	Production Line	
<small>Cool Roof Rating Council ratings are determined for a fixed set of conditions, and may not be appropriate for determining seasonal energy performance. The actual effect of solar reflectance and thermal emittance on building performance may vary.</small>			
<small>Manufacturer of product stipulates that these ratings were determined in accordance with the applicable Cool Roof Rating Council procedures.</small>			

If the aged value for the reflectance is not available in the CRRC Rated Product Directory, the equation below is used.

**Equation 9-1: Aged Reflectance**

$$Aged\ Reflectance_{calculated} = (0.2 + \beta * [\rho_{initial} - 0.2])$$

Where:

$\rho_{initial}$  = Initial Reflectance listed in the CRRC Rated Product Directory

$\beta$  = soiling resistance value listed in Table 9-10

**Table 9-10: Soiling Resistance Value  $\beta$ , by Product Type**

PRODUCT TYPE	$\beta$
Field-applied coating	0.65
Other	0.70

Since this is not a mandatory requirement, prescriptive compliance for a given roof slope and climate zone require a minimum reflectance and emittance, can be met using one of the exceptions above or by using the performance compliance approach.

**Example 9-14**

**Question:**

There is a Victorian building that has been converted into an office building and needs to have a shake roof replacement. This building has a vented unconditioned attic with the insulation on the ceiling. Would I need to meet §150.2(b)Hi?

**Answer:**

No, this section does not apply. The occupancy type has been changed to nonresidential. Since the Victorian building has a shake roof and is considered a steep-sloped roof, §141.0(b)2Bib for nonresidential buildings would apply.

**Example 9-13**

**Question:**



On an existing building, 50 ft<sup>2</sup> of 85 ft<sup>2</sup> of vertical glazing is being removed from an existing south-facing wall and new glazing will be replaced as part of the alteration in the same opening. What requirements apply?

**Answer:**

Since 50 ft<sup>2</sup> is "replacement" fenestration and 35 ft<sup>2</sup> is existing, the replaced fenestration must comply with the §150.2(b)1B. For this example, Exception 1 to §150.2(b)1B can be used. This allows vertical fenestration no greater than 75 ft<sup>2</sup> to meet have a U-factor no greater than 0.40 in Climate Zones 1-16 and an SHGC of 0.35 or less in Climate Zones 2, 4, and 6 through 15.

**Example 9-14**

**Question:**

Why is the low-sloped roofing products requirement listed for only Climate Zones 13 and 15?

**Answer:**

These two climate zones are the only climate zones that show energy cost-effectiveness for having a low-slope roofing product (cool roof) requirement.

**Example 9-15**

**Question:**

Why are there so many exceptions to the addition and alterations section that can be considered equivalents to roofing products?

**Answer:**

There are several energy features that are equivalent or having a greater impact on energy savings than the roofing products. For example, older homes often have ducts under the house, and newer homes may have materials slightly below current requirements or equal to one of the items considered to be equivalent. If the ducts are insulated and air leakage controlled to meet current requirements, energy savings are expected to be at least equal the benefit of reflective roof coverings.

**Example 9-16**

**Question:**

What happens if I have a low-slope roof on most of the house but a steep-sloped roof on another portion? Do I have to meet two criteria for the roofing products?

**Answer:**

Yes. If your house is in Climate Zone 13 or 15, you will need to meet the low-slope criteria for the areas with low slope. The areas with the steep-slope roof will need to meet the other cool roof criteria.

**Example 9-17**

**Question:**

I am replacing my existing wood shake roof with asphalt shingles. Would this be considered a repair?

**Answer:**

No. A repair is defined as a reconstruction or renewal for maintenance of any component, system, or equipment of an existing building. A replacement of any component (i.e., roof-top), system, or equipment for which there are requirements in the Energy Code is considered an alteration and not a repair.

**Example 9-18****Question:**

If a radiant barrier is required for my addition, where does it need to be installed?

**Answer:**

The radiant barrier needs to be installed only on the underside of an attic roof assembly and the gable wall ends associated with the addition.

**Example 9-19****Question:**

I am considering reroofing my house. Under what conditions will I be required to put on a cool roof?

**Answer:**

Cool roof requirements are triggered when 50 percent or more of the roof area is being replaced. Prescriptive requirements are waived if one of the exceptions to §150.2(b)1H below applies:

**Prescriptive Exceptions for Steep-Sloped Roofs**

1. Air-space of 1.0 inch (25 mm) is provided between the top of the roof deck and the bottom of the roofing product.
2. The installed roofing product has a profile ratio of rise to width of 1 to 5 for 50 percent or greater of the width of the roofing product.
3. If existing ducts in the attic are insulated and sealed according to §150.1(c)9.
4. Buildings have at least R-38 ceiling insulation.
5. Buildings have an attic radiant barrier meeting the requirements of §150.1(c)2.
6. Buildings have no ducts in the attic.
7. Buildings are in Climate Zones 10-15, R-2 or greater insulation above the roof deck.

**Prescriptive Exceptions for Low-Sloped Roofs**

1. Buildings have no ducts in the attic.

2. Aged solar reflectance and roof deck insulation R-value in Table 150.2-A are met. Alternatively, the building may show compliance using the performance approach.

### **Example 9-20**

#### **Question:**

I am building a 450 ft<sup>2</sup> addition on my house. Do I have to meet cool roof requirements in the prescriptive package?

Answer:

Yes. Once the addition exceeds 300 ft<sup>2</sup>, if using prescriptive compliance is in a climate zone with a cool roof requirement, the roof must meet the requirements for the type of roof slope. To avoid the cool roof requirements for this addition, you may use the performance approach and trade-off against other energy efficiency features of the addition alone or the existing building by using the Existing + Addition + Alterations approach.

### **Example 9-21**

#### **Question:**

When doing a full roof replacement on a steep slope roof in climate zone 12 with new integrated photovoltaic roofing product, does the roofing product need comply with the Energy Code requirements in Section 150.2(b)1?

**Answer:**

Yes. The roofing product must comply with the Energy Code and be rated by the Cool Roof Rating Council. Only the active photovoltaic area of the roof is exempt from these requirements.

---

## **9.4.4.2 Insulating Existing Roof/Ceilings**

### **A. Rafter Roofs and Unvented Attics**

When insulating a rafter roof, at least R-19 (maximum U-factor of 0.054) is required.

When a roof surface is altered, if the space between framing members becomes accessible, the ceiling/roof is considered altered, and insulation is required.

The prescriptive requirement for alterations to walls and floors is to add the equivalent of the specified level of insulation that fits within the cavity of wood-framed assemblies:

1. R-13 in 2x4 exterior walls, and R-20 in 2x6 or greater exterior walls (no exterior continuous insulation is required); or
2. Existing 2x4 exterior walls that already have R-11 insulation installed in framed walls are exempt from the mandatory minimum R-13 wall insulation required

by §150.0(c)6; or

3. R-19 in raised floors over crawl spaces, over open outdoor areas, unheated basements, and garages.

## **B. Vented Attics**

Attic insulation and air sealing prescriptive requirements in vented attics apply when the ceiling above a conditioned space is altered or when an entirely new duct system is installed in the vented attic. A ceiling may be considered altered under various conditions including when the existing attic insulation is replaced, new attic insulation is added, or the ceiling plane is replaced.

Most single-family homes in California contain vented attics. On hot days, a typical vented attic is hotter than outside and if poorly ventilated the temperature difference between the attic and outdoors can be substantial. In homes with little or no attic insulation, this temperature difference can result in significant total heat gain or loss through the ceiling. High levels of attic insulation and an air barrier at the ceiling is an important approach to minimize those gains and losses and result in considerable energy savings.

A common circumstance that results in the disruption of existing attic insulation occurs when a new duct system is installed in a vented attic. At minimum, existing insulation is moved to access certain areas and then replaced. Sometimes, insulation is disturbed and left unfixed. In cases where penetrations are added to the ceiling layer for new registers, air sealing is critical to limit gains or losses to and from the home. By requiring insulation improvements and proper air sealing at duct replacement, vented attics are addressed as a system saving energy and improving comfort for the occupant.

When an attic is altered or a new duct system is installed, there are four primary sets of requirements that must be met as listed below.

1. Air seal the ceiling between conditioned spaces and the unconditioned attic.
2. Insulate the attic floor over any conditioned spaces to R-49.
3. Insulate over all recessed can lighting fixtures. Any recessed can lighting fixtures not rated for insulation contact (IC-rated) must be replaced with IC-rated fixtures or have a fire rated cover installed over the attic side of the fixture to allow for insulation to be installed over the fixtures.
4. Ensure attic ventilation meets California Building Code requirements.

A HERS Rater is not required to verify any of these prescriptive requirements. All requirements will be verified by an official from the building department.

These components combine to form a package that addresses many issues in existing attics. Combined they provide a much greater benefit than any of these

measures do on their own. If an attic is insulated without first air sealing the ceiling assembly, the opportunity to seal any penetrations between the attic and conditioned space below is lost, and sealing can only be performed in the future if the insulation is removed. Once installed, R-49 insulation is 16-20" deep and it becomes a challenge to maneuver around the attic space. Air infiltration through the ceiling plane between the attic and conditioned space also reduces the effectiveness of attic insulation.

Items #1 through #3 above may or may not be required depending on climate zone and the existing attic insulation level. For projects that are subject to all or a portion of these requirements, the first step is to identify which requirements apply. Air sealing, recessed cans, and attic ventilation must be addressed prior to adding attic insulation. Table 9-11 below summarizes when these prescriptive requirements apply.

**Table 9-11: Altered Attic Requirements by Climate Zone**

<b>Climate Zones</b>	<b>Building with &lt; R-19 existing attic insulation</b>	<b>Building with ≥ R-19 existing attic insulation</b>
5, 7	Attic ventilation only <sup>1</sup>	Attic ventilation only
6	R-49, attic ventilation	Attic ventilation only
1, 3	R-49, recessed cans, attic ventilation	Attic ventilation only
2, 4, 8-10	R-49, recessed cans & air sealing, attic ventilation	R-49, attic ventilation
11-16	R-49, recessed cans & air sealing, attic ventilation	R-49 & recessed cans, attic ventilation

<sup>1</sup>Mandatory minimum R-19 insulation requirements still apply if the ceiling is being altered.

Source: California Energy Commission

If any of the following four conditions are met, the project is exempt from all of the four requirements:

- (a) Existing attic insulation of R-38 or better.
- (b) Alteration directly causes the disturbance of asbestos located in the ceiling, attic, or ductwork and remediation of asbestos is not being done as part of the scope of work.
- (c) Knob and tube wiring located in the attic, which is not being removed as part of the scope of work.
- (d) Altered attic space is shared with other dwelling units whose attic space is not considered altered.

If any of the exceptions are being claimed the existing conditions must be documented on the Certificate of Compliance which can be completed and signed by the homeowner, contractor, energy consultant, or any other party taking

responsibility for the documentation. The existing conditions will be verified by the building official.

To qualify for the exceptions based on a minimum of R-19 or R-38 attic insulation, existing insulation must be documented to meet the minimum levels on the Certificate of Compliance. To verify the existing insulation R-value, the depth of insulation must be measured. To obtain an accurate measurement it's recommended to measure in at least two places and take the average. If the depths across various sections of the attic differ by more than two of inches, measurements at the lower sections should be used. For example, if half of the attic has 6 inches of insulation and the other half has only 3-1/2" of insulation, a depth of 3-1/2" should be used for purposes of determining the existing insulation level. Next, multiply the depth of insulation by the R-value per inch based on the insulation product type. See Table 9-12 below for typical insulation densities for various product types. For the example above, if the insulation was high density cellulose at R-3.2 per inch, then the R-19 minimum condition is not met because half of the attic has insulation with an R-value of approximately R-13.

**Table 9-12: Typical Insulation R-Values per Inch**

Typical Insulation R-values		
Insulation Type	R-value per inch	Typical Applications
Cellulose, loose fill	3.7	Attic Floor
Cellulose, high density	3.2	Walls, Enclosed Cavities, Framing Transitions
Fiberglass, batts	3.0*	Basement Ceiling, Open Stud Walls, Attic Floor*
Fiberglass, loose fill	2.8	Attic Floor, Walls (existing)
Fiberglass, loose fill, fluffed below manufacturer's standards	uncertain	Do not install, or correct by blowing over with higher density
Rockwool	3.0	Attic Floor, Walls, Basement Ceiling (may be loose or batts)
Vermiculite	2.7	Attic Floor
Poly-isocyanurate, rigid board	7.0	Foundation Walls, Attic Access Doors
Polystyrene, expanded rigid board	4.0	Foundation Walls, Sill Plate
Polystyrene, extruded rigid board	5.0	Foundation Walls, Sub-Slab, Sill Plate
Low Density Urethane, sprayed foam	3.7	Attics, Walls (new construction); Sill Plate, Band Joist, Framing Transitions
Urethane, sprayed foam	6.0	Attics, Walls (new construction); Sill Plate, Band Joist, Framing Transitions
Urea Formaldehyde Foam	4.0	Attics, Walls (existing)

Below is additional detail on each of the four prescriptive requirements.

**1. Air Sealing**

In Climate Zones 2, 4, and 8 through 16, where existing attic insulation is less than R-19, all accessible areas of the attic floor between the attic and the conditioned space must be air sealed (see Table 9-13). Homes with atmospherically vented space heating or water heating combustion appliances located inside the building pressure boundary are exempt from this requirement. This exception does not cover combustion appliances located in a vented attic, garage, or crawlspace.

**Table 9-13: Attic Air Sealing Requirements by Climate Zone**

<b>Climate Zones</b>	<b>&lt; R-19 existing attic insulation</b>	<b>≥ R-19 existing attic insulation</b>
1, 3, 5-7	No requirement	No requirement
2, 4, 8-10	Yes	No requirement
11-16	Yes	No requirement

Source: California Energy Commission

Addressing air leakage requires removing or temporarily moving any existing insulation around the attic to access the attic floor. Most air sealing can be completed with caulking or foam. Areas where large holes might exist, such as at soffits and dropped ceilings, will require an air barrier to be installed if not already in place and the perimeter will need to be secured and fully sealed. Areas that present sources of air leakage that should be inspected when sealing the attic include:

- Soffits, dropped ceilings, and chases connected to conditioned space
- Gaps around chimneys and combustion venting
- Along the top plate
- Electric and plumbing penetrations
- Ceiling mounted duct boots
- Ceiling mounted exhaust fans and exhaust ducts
- Attic hatches
- Kneewalls
- Recessed lighting fixtures

## **2. Recessed Can Lighting**

In Climate Zones 1-4 and 8-16 any recessed can fixtures in the ceiling shall be covered with insulation to the same depth as the rest of the attic floor. Fixtures not rated for insulation contact must be replaced or retrofitted with a fire-proof cover that allows for insulation to be installed directly over the cover. Homes in Climate Zones 1-4 and 8-10 with existing attic insulation of R-19 or greater are exempt from this requirement. Table 9-14 summarizes the recessed can lighting requirements by climate zone and existing insulation value.

**Table 9-14: Recessed Can Lighting Requirements by Climate Zone**

<b>Climate Zones</b>	<b>&lt; R-19 existing attic insulation</b>	<b>≥ R-19 existing attic insulation</b>
5-7	No requirement	No requirement
1-4, 8-10	Yes	No requirement
11-16	Yes	Yes

For recessed can fixtures to be directly covered with insulation the fixtures must be rated for Insulation Contact (IC). Fixtures that are IC rated usually have an Underwriters Laboratory (UL) sticker or stamp on the inside of the housing that says "IC" in some form. The lamp will likely need to be removed to properly view the housing. If the housing has slits or holes in it, it is not IC rated. If it cannot be determined whether a fixture is IC rated or not, it should be assumed that it is not. Recessed cans that are not IC rated present a serious fire hazard if they are surrounded by any flammable material because of the heat generated by the fixture. In these cases, the fixtures must be dammed to maintain separation between them and the attic insulation. This results in areas of the attic floor with minimal or no insulation where heat gains and losses are high, contributing to degraded insulation performance across the entire attic.

When present, older recessed can lighting can be a significant contributor to air leakage through a ceiling plane. Existing recessed cans typically are not airtight, and their perimeter can present a path for conditioned air to flow into the attic or unconditioned attic air to enter the conditioned space below. In addition to an IC rating, recessed can fixtures can also be rated to be "Airtight". This prescriptive standard does not require that existing fixtures be airtight. However, if existing recessed fixtures are being entirely replaced with new luminaires, the requirements of Section 150.0(k)1C must be met which requires the fixtures be certified as airtight with air leakage tested in accordance with ASTM E283 to be less than 2 cfm at 75 Pascals. Existing fixtures that are IC rated but not airtight can be retrofit with a retrofit trim kit which provides an airtight enclosure. Recessed cans that are not IC or AT rated may be replaced with IC rated housing units designed for retrofit applications.

In some cases, a fire-rated attic recessed light cover, shaped as domes or boxes, can be installed over the fixture allowing for insulation to be installed directly up to and over the cover. The recessed can fixture must have a thermal switch, which disconnect the electricity to the light if the temperature exceeds unsafe levels. The covers are to be installed over existing fixtures and sealed around the perimeter to the ceiling floor. Example covers include the TENMAT and Insullite covers (see Figure 9-6). Products that act as dams for the can lighting but do not allow insulation to cover the area over the fixture are not acceptable for meet these prescriptive requirements. If it cannot be determined whether the fixture has



a thermal switch, assume that it does not, and a fire-rated recessed light cover cannot be used.

**Figure 9-6: Example fire rated cover products. Left is Tenmat, and right is Insullite.**



(1) <https://www.recessedlightcover.com/product-selection/tenmat-ff130e-recessed-light-draft-stop-cover/>

(2) [https://insulation4us.com/products/recessed-light-cover-solid-insullite-all-sizes?variant=32508051849265&qclid=CjwKCAjwqckFBhAhEiwAfer7zfAPOJY7SqKTCmwahDo05n7kikNhzihRNF6K\\_VJccWpRpaDuLdEyXhoCVgUQAvD\\_BwE](https://insulation4us.com/products/recessed-light-cover-solid-insullite-all-sizes?variant=32508051849265&qclid=CjwKCAjwqckFBhAhEiwAfer7zfAPOJY7SqKTCmwahDo05n7kikNhzihRNF6K_VJccWpRpaDuLdEyXhoCVgUQAvD_BwE)

### 3. Attic Insulation

In all climate zones, except 5 and 7, attic insulation shall be installed at the attic floor to a level of R-49 or to achieve a weighted U-factor of 0.020. Table 9-15 summarizes the insulation requirements by climate zone, based on whether the existing attic insulation meets a minimum R-19 or not.

**Table 9-15: Attic Insulation Requirements by Climate Zone**

Climate Zones	< R-19 existing attic insulation	≥ R-19 existing attic insulation
5, 7	No requirement	No requirement
1, 3, 6	R-49	No requirement
2, 4, 8-16	R-49	R-49

In cases where there is limited vertical height in an attic (preventing the installation of the required insulation R-value), an exception allows for the installation of a lower R-value. Insulation must still be installed to maximize the depth of insulation while still meeting code requirements for roof ventilation as specified in Section 806.3 of the California Residential Code (Title 24, Part 2.5). A minimum of 1 inch air gap must be provided between the insulation and roof deck as well as at all vent locations. The use of blocking, bridging and insulation must not block the free flow of air.

Attic insulation is either batt, loose fill (blown-in), rigid, or spray foam and can be made of various materials. Most new and retrofit attics use blown-in fiberglass or cellulose insulation. Blown-in insulation is a loose fill product

installed using a blowing machine with a large, attached hose. While both blown-in and batt insulation have similar properties, it is much easier to achieve a consistent installation with loose fill since the particles more easily fill in small gaps and hard to reach areas. R-value ratings per inch vary somewhat by product type and across manufacturers. Manufacturers provide coverage charts which specify how many bags of insulation are needed to cover a certain square footage based on the ceiling framing spacing and depth. The charts account for settling of the insulation due to compression under its own weight.

Insulation must be installed evenly throughout the attic space and insulation levels must be documented on the certificate of installation (CF2R). The insulation level can be verified by checking that the depth of insulation conforms to the manufacturer's coverage chart for achieving the required R-value. The insulation also must meet the manufacturer's specified minimum weight per ft<sup>2</sup> for the corresponding R-value. When using loose fill insulation at the ceiling, baffles should be installed at eaves or soffit vents to keep the insulation from blocking ventilation and prevent air movement under the insulation. Attic access doors shall have permanently attached insulation using adhesive or mechanical fasteners.

#### **4. Attic ventilation**

When any work is conducted in an existing attic, ventilation is required to be reviewed and altered as necessary to ensure compliance with current code requirements per the California Building Code. Ventilation allows the natural flow of air that removes accumulated warm air and moisture from the attic. The relevant requirements that usually need to be addressed from Title 24, Part 2.5 Section R806 are listed below.

- A minimum net free ventilating area of 1/150 of the area of the attic space.
- Ventilation openings shall be no smaller than 1/16" and no greater than 1/4".

Ridge baffles should be installed when ceiling insulation is next to eave or soffit vents. The baffles should be placed at the top plate to direct ventilation air up and over the ceiling insulation. It is important to ensure the baffle extends sufficiently beyond the height of the ceiling insulation so as not to disturb the insulation.

#### **Example 9-22**

##### **Question:**

I want to improve the performance of my existing vented attic and add attic insulation. The existing insulation is only about 3 inches deep. Is there a

minimum insulation level that I must meet? Are there other requirements that apply to my project?

**Answer:**

In Climate Zones 1 through 4, 6, and 8 through 16, a minimum of R-49 insulation shall be installed at the ceiling level or a weighted U-factor of 0.020 shall be achieved. In Climate Zones 5 and 7 only the mandatory minimum R-19 ceiling insulation must be met. Additionally, air sealing of all accessible areas between the attic and conditioned space is required in Climate Zones 2, 4, and 8 through 16. The air sealing should be performed in accordance with Section 110.7. In Climate Zones 1 through 4 and 8 through 16 any existing recessed can lights must be rated for insulation contact or retrofitted with a fire-proof cover that allows for insulation to be installed directly over the cover. In all climate zones, if attic ventilation does not meet California Building Code requirements it must be increased to meet current code. There are exceptions for various existing conditions, see Section 9.4.4.2 for further detail.

**Question:**

What if I have an atmospherically vented water heater inside a closet in my house?

**Answer:**

If space heating or water heating combustion appliances that are atmospherically vented are located inside the pressure boundary of the home, the project is exempt from the air sealing requirement. The other requirements still apply based on climate zone.

**Question:**

What if my existing ceiling insulation is R-19?

**Answer:**

With an existing minimum insulation level of R-19, in Climate Zones 1, 3, and 5-7 none of the attic insulation, air sealing, or insulation covering recessed can requirements apply. In Climate Zones 2, 4, and 8-16 projects are only required to meet the insulation and attic ventilation requirements and are exempt from the air sealing and insulation covering recessed can requirements.

**Question:**

What if my existing ceiling insulation is R-38?

**Answer:**

The project is exempt from all the prescriptive requirements.

**Example 9-23****Question:**

I am installing two new recessed can fixtures in my kitchen, do I have to meet the prescriptive attic insulation and air sealing requirements for an altered ceiling?

**Answer:**

No, this is a lighting alteration and does not constitute a ceiling alteration. The new recessed can fixtures must meet the requirements of Section 150.0(k).

**Example 9-24****Question:**

I am installing a new duct system in my vented attic, but I have asbestos insulation and knob and tube wiring, am I required to insulate and air seal my attic?

**Answer:**

No, the project is exempt from all the prescriptive requirements if either asbestos or knob and tube wiring is in the vented attic where work is being conducted. If asbestos abatement is occurring to remove asbestos on existing ductwork, and no other exceptions exist, then the prescriptive requirements still apply.

**9.4.4.3 Fenestration and Doors****1. Replacement Fenestration**

Any fenestration (i.e., windows, skylights, clerestories, and glazed doors) that is being removed and replaced in an exterior wall or roof is considered "replacement fenestration."

Replacement fenestration is an area of new fenestration that replaces an equal or lesser area of glazing removed in the same existing wall or roof area. It is labeled as "altered" fenestration, and it need not occur in the same openings as the glazing being removed as long as it is being installed in the same existing wall or roof surface that remains a part of the existing building. Any added fenestration area that is larger than the total altered glazing area is labeled as "new."

**2. New Fenestration in Alterations**

The Energy Code has relaxed some of the prescriptive restrictions on new vertical fenestration for alterations in existing homes. When new vertical fenestration is added in existing dwellings, up to 75 ft<sup>2</sup> are not required to meet the overall total fenestrations limit (20 percent of the CFA) and the west facing area limit (5 percent of the CFA). This provides for additional flexibility to meet the Energy Code

requirements using the prescriptive approach, without having to comply using the performance approach. However, this additional fenestration must meet the prescriptive U-factor and SHGC requirements or meet the U-factor and SHGC requirements of Exceptions 1 and 2 to §150.2(b)1B.

### 3. Greenhouse Windows

Greenhouse or garden windows are special windows that project from the façade of the building and are typically five-sided structures. An NFRC-rated U-factor for greenhouse windows is typically high and may not meet the mandatory requirements for the fenestration U-factor of 0.58.

To meet this mandatory requirement, greenhouse windows:

1. Must have a maximum U-factor of 0.58 or better; or
2. Must use the area-weighted average for all new and replacement fenestration with a combined mandatory maximum of 0.58 U-factor as per §150.0(q)2; or
3. Must meet the Exception 1 to §150.0(q)1 for up to 10 ft<sup>2</sup> or 0.5 percent of CFA, whichever is greater.

### 4. Exterior Doors

Alterations that add exterior door area must meet the same requirements as newly constructed buildings (Section 150.1(c)5) which requires a maximum U-factor of 0.20 for swinging doors. Swinging doors between the garage and conditioned space that are required to have fire protection are exempt from the U-factor requirement.

### 5. Labeling, Certification, and Other Mandatory Requirements

See Chapter 3 for a full list of mandatory requirements for certification and labeling for fenestration products and exterior doors (§110.6), and air leakage requirements (§110.7).

---

#### Example 9-25

##### Question:

An alteration in Climate Zone 12 is to move an existing 25 ft<sup>2</sup> window to another location within the same existing wall. What prescriptive requirements does the relocated window need to meet?

##### Answer:

Removing glazing from an existing wall and reinserting up to the same area of glazing in a different opening is an alteration, covered by §150.2(b)1B. Exception 1 to §150.2(b)1B states that up to 75 ft<sup>2</sup> of vertical replacement fenestration is allowed to meet a prescriptive requirement of 0.40 U-factor and 0.35 SHGC.

#### Example 9-26

**Question:**

For additions and alterations that include a greenhouse window (also known as garden window), how do I measure the fenestration area? What U-factor and SHGC requirements apply to a greenhouse window?

**Answer:**

The area of a greenhouse windows is the rough opening in the wall.

The default U-factor for greenhouse windows does not meet the mandatory maximum fenestration U-factor of 0.58 (there is no mandatory SHGC requirement). A metal-framed greenhouse window from Table 110.6-A has a 1.40 U-factor and the default SHGC from Table 110.6-B is 0.73 (for fixed, clear glass). By comparison, fenestration in prescriptive additions has to meet the prescriptive U-factor of 0.30 for all climate zones and an SHGC of 0.23 in all climate zones except 1, 3, 5, and 16, which have no SHGC requirement. There are two options to meet the mandatory U-factor requirement: (1) up to 30 ft<sup>2</sup> is exempt (§150.0[q], Exception 2), and (2) a weighted-average U-factor with other fenestration products is allowed.

For additions and alterations, Exception 1 to §150.2(b) allows any dual-pane greenhouse window to meet the prescriptive U-factor requirement (separate from the mandatory requirement). This makes it possible for greenhouse windows to comply as part of a prescriptive alteration if there is no SHGC requirement (Climate Zones 1, 3, 5, and 16). For climate zones with an SHGC requirement, if other windows are being altered, a weight-average SHGC may be calculated, or performance compliance is an option for achieving compliance. Compliance will likely depend on higher-than-average energy efficiency for some other components of the project to offset the poor performance of the greenhouse windows.

For other alternatives, see Chapter 3.

**Example 9-27****Question:**

An existing house in Climate Zone 12 has all single-pane windows. Most of the windows (300 ft<sup>2</sup> total) will be replaced within existing openings. One existing 30 ft<sup>2</sup> window is being replaced with a pair of 40 ft<sup>2</sup> French doors. What requirements apply to this project?

**Answer:**

For prescriptive compliance, replacement fenestration (equal to or less than the area of existing windows in each wall being altered) and added fenestration area must meet the U-factor (0.30) and SHGC (0.23) in Table 150.1-A or B. There are only 10 ft<sup>2</sup> of added fenestration, so the project meets Exception 1 to §150.2(b)1A and is not required to meet the prescriptive total glazing area requirement. All installed fenestration also must meet applicable mandatory requirements.

For performance compliance:

(a) Using the Existing + Alterations approach *without* third-party verification, replacement fenestration that achieves the fenestration values in Table 150.2-D of the Energy Code is compared to those same values in the standard design. Replacement fenestration that does not reach these values is penalized.

(b) Using the Existing + Alterations approach *with* third-party verification, replacement fenestration that achieves the fenestration values in Table 150.2-D of the Energy Code is compared to §Tables 110.6-A and 110.6-B default values for the existing fenestration condition. Replacement fenestration that does not reach these values is penalized.

### **Example 9-28**

#### **Question:**

An existing building has all single-pane, metal-frame windows. A proposed remodel will replace all the windows; no other work is being done as part of the remodel. What applies?

#### **Answer:**

All replacement windows must meet the prescriptive requirements (§150.2[b]1B), and new fenestration must meet applicable mandatory requirements of C1V10.6, 110.7, and 150.0.

If the prescriptive requirements cannot be met, the Existing + Alteration performance method can be used.

### **Example 9-29**

#### **Question:**

An existing building has all single-pane, wood-framed windows. In addition to replacing more than 75 ft<sup>2</sup> of window area, two double-pane, metal-frame greenhouse windows will be added. How should the greenhouse windows be shown to comply using the prescriptive standards?

#### **Answer:**

Greenhouse windows add conditioned volume but do not add conditioned floor area. There are three unique requirements (1) prescriptive SHGC, (2) prescriptive U-factor, and (3) mandatory U-factor. Any dual-glazed greenhouse windows installed as part of an alteration must meet any SHGC requirements (0.23 or lower in Climate Zones 2, 4, 6-15, no requirement in other climate zones). While the prescriptive U-factor requirements do not apply (§150.2[b] Exception 1), all applicable mandatory requirements must be met. This includes §150.0(q), which requires a maximum weighted average U-factor of 0.58 or less. Exception 2 exempts up to 30 ft<sup>2</sup> from this requirement.

---

## **9.4.5 Water Heating Alterations**

For a replacement water heater, there are separate requirements for the distribution system and the water heater. The requirements for pipe insulation are mandatory

and cannot be traded off. For the distribution system and the water heater, if the prescriptive requirements cannot be met, then the performance compliance method can be used to comply.

The mandatory pipe insulation requirement includes the following:

1. Any newly installed and existing accessible piping must meet mandatory insulation requirements in §150.0(j)1.

To meet the prescriptive requirements, the replacement water heater must be one of the following:

1. Any natural gas or propane water heater
2. A single heat pump water heater meeting NEEA Tier 3 or higher specifications.
3. A single heat pump water heater, (1) located in an unconditioned space like the garage or in conditioned space, (2) placed on an incompressible (rigid) surface that is insulated to a minimum R-10, and (3) installed with a communication interface (demand control device) meeting §110.12(a), or has an ANSI/CTA-20450B communication port.
4. If the existing water heater is an electric resistance water heater, a replacement electric resistance water heater may be installed.
5. A water-heating system determined by the California Energy Commission's Executive Director to use no more energy than those specified above.

If a recirculation system is installed, then it must be a demand recirculation system with a manual on/off control to meet the prescriptive requirements.

#### **9.4.5.1 Trouble-shooting Water Heater Problems**

If installing a recirculation system to reduce the long wait time for hot water, the only system type allowed in an alteration is a demand recirculation system with manual on/off controls. Any other alteration to the hot water distribution system, such as timer or temperature control recirculation systems, must be analyzed using the performance compliance approach to show that the energy use of the building has not been increased.

Another alternative is to install a natural gas or propane instantaneous (tankless) water heater closer to the fixtures having problems. Any other type of water heater may be installed as long as compliance is demonstrated using the performance compliance approach. (See Section 9.5.)

For more information on any of these requirements, see Chapter 5.

---

#### **Example 9-26**

##### **Question:**



I want to install a second water heater for an addition to a single-family home with an existing natural gas water heater. Does this comply?

**Answer:**

It depends on the type of water heater. A heat pump water heater or instantaneous gas or propane water heater meeting certain conditions of 200,000 Btu/h or less complies with §150.2(a)1D. For small additions 500 square feet or less an instantaneous electric water heater meeting certain conditions is also allowed. Otherwise, performance compliance may be used to demonstrate compliance.

**Example 9-27**

**Question:**

An existing 1,500 ft<sup>2</sup> single-family home is getting a 500 ft<sup>2</sup> addition. A new 50-gallon gas water heater will replace the existing water heating system. How do the water heating requirements apply?

**Answer:**

Because this is an alteration or replacement (§150.2[b]1H) of an existing water heating system, this proposed replacement meets the requirement of §150.2(b)1Hiii.

Any applicable mandatory requirements must also be met. For newly installed piping and existing accessible piping, all the applicable insulation requirements of §150.0(j)1 shall be met. If building energy compliance is achieved with the existing + addition + alterations calculation, the UEF or EF and other energy features of the altered water heating system are modeled in the performance method.

**Example 9-28**

**Question:**

An existing 2,000 ft<sup>2</sup> single-family house has one 50-gallon gas water heater, and a 600 ft<sup>2</sup> addition with a new instantaneous gas water heater is proposed. How does this comply?

**Answer:**

When there is an increase in the number of water heaters with an addition, the Energy Code allows addition-alone compliance in certain circumstances. An instantaneous gas water heater of 200,000 Btu/h or less is one of those circumstances. Compliance with applicable mandatory requirements is also needed.

The alternative to show compliance is by using the existing-plus-addition or whole-building compliance.

**Example 9-29**

**Question:**

An existing single-family home with one electric water heater has a 500 ft<sup>2</sup> addition with a 30-gallon electric water heater proposed. Does this comply with prescriptive addition requirements?

**Answer:**

No. When there is an increase in the number of water heaters with an addition, . Per 150.2(a)1Div, the only prescriptive electric resistance option for additions up to 500 ft<sup>2</sup> is an instantaneous water heater.

Performance compliance may be possible. There is a significant penalty for this type of electric resistance water heating.

**Example 9-30 – Alterations**

**Question:**

If my house has an electric-resistance water heater and I plan to upgrade my water heater, do I need to install a gas instantaneous, gas storage water heater, or HPWH?

**Answer**

No, if natural gas is not already connected to the existing water heater location, then a consumer electric water heater that meets the requirements of California's Appliance Efficiency Regulations can replace the existing water heater. If installing new piping to the water heater, then you will need to comply with the mandatory pipe insulation requirements. See Section 5.3.5.1 for more information on pipe insulation requirement.

---

### **9.4.6 HVAC System Alterations**

If the heating and cooling system is unchanged as part of an addition or alteration, compliance for the HVAC system is not necessary. However, altering or replacing any component of a system typically triggers requirements for that component, as well as a requirement for duct sealing and leakage testing. Residential Appendices RA3 contains the applicable field verification and diagnostic test protocols that must be followed.

Energy Code requirements are determined by the type of the work performed on the existing space conditioning system. In practice, this work is commonly referred to as an "HVAC changeout". The two types of HVAC changeouts are:

1. Entirely new or complete replacement space conditioning systems
2. Altered space conditioning systems (equipment and/or ducts)

#### **9.4.6.1 Entirely New or Complete Replacement Space Conditioning Systems**

A system installed in an existing dwelling as part of an alteration shall be considered entirely new when:

1. The air handler and all the system heating/cooling equipment (e.g., outdoor condensing unit and indoor cooling or heating coil for split systems; or complete replacement of a package unit), are new.
2. The duct system is entirely new (including systems with less than 40 feet in length).

An entirely new or complete replacement must meet all applicable mandatory requirements and prescriptive requirements as described below (See Chapter 4 for details).

1. §150.0(h)1-2: Cooling and heating load calculations.
2. §150.0(h) 3: Outdoor condensing unit requirements.
3. §150.0(h)4: Heating furnace temperature rise requirements.
4. §150.0(i): Setback thermostats or controlled by EMCS.
5. §150.0(j)1-2: Pipe insulation.
6. §150.0(m)1-10: Duct insulation, labeling, & damper requirements.
7. §150.0(m)12: Air filtration requirements.
8. §150.0(m)13: Static pressure probe, airflow, and fan efficacy requirements (or alternative return duct sizing as per Table 160.3-A and B).
9. §150.1(c)7: Prescriptive refrigerant charge verification.
10. §150.2(b)1G: Electric resistance heating restrictions
11. Table 150.2-A: Prescriptive duct insulation.

#### 9.4.6.2.1 Altered Duct Systems

New ducts that are installed to replace or extend existing ducts must comply with the mandatory duct insulation, labeling and damper requirements of §150.0(m)1-10 (see Chapter 4 for details). When more than 25 feet of new ducts are installed, additional duct insulation and duct sealing and leakage testing requirements must be met, as described below.

New ducts installed in an unconditioned space must be insulated to a minimum R-value as described in Table 9-16.

**Table 9-16: Duct Minimum R-Value (from Energy Code Table 150.2-A)**

Climate Zone	3, 5 through 7	1, 2, 4, 8 through 16
Duct R-value	R-6	R-8

Source: California Energy Commission

The duct system must also be sealed by the installer and verified by a HERS Rater as specified in RA3.1 (duct leakage test), regardless of whether the ducts are

located in unconditioned space. The only exception is if the existing duct system contains asbestos.

- If the new ducts form an entirely new duct system, the measured duct leakage must be equal or less than 5 percent of the system airflow. The duct system must also meet the air filtration requirements, and the static pressure probe, airflow, and fan efficacy requirements (§150.0[m]12 and §150.0[m]13). If the air handler and ducts are located in a vented attic, then attic and air sealing requirements (§150.2[b]1J) apply, as described in Section 9.4.4.2. An entirely new duct system is having at least 75 percent of new duct material, and up to 25 percent of reused parts that must be accessible.
- If the new ducts (more than 25 feet installed) do not form an entirely new duct system, the measured duct leakage must be equal to or less than 10 percent of the system airflow, or the measured duct leakage to outside must be equal to or less than 7 percent of the system airflow. If it is not possible to meet either of these duct leakage targets (which must be performed first), then all accessible leaks must be sealed and verified through a visual inspection and a smoke test by a HERS rater.

Additionally, when altered ducts, air-handling units, cooling or heating coils, or plenums are located in a garage, the ducts must be sealed by a HERS rater to a measured duct leakage of 6 percent or less of the system airflow. The alternative to this is having all accessible leaks located in the garage space sealed and verified through a visual inspection and a smoke test by a HERS rater. This requirement applies when any length of new ducts is installed (not limited 25 feet of ducts).

When performing a visual inspection and smoke test, sampling is not allowed. The HERS rater must perform the inspection and test on every house. Some judgement is required in determining if ducts are accessible, where the local enforcement agency will have the final say when it is not immediately obvious.

#### **9.4.6.2.2 Altered Space Conditioning Equipment**

New space conditioning equipment that is installed, typically as equipment replacements, must comply with the applicable mandatory requirements for the new equipment (See Chapter 4 for details). In addition, this altering of space conditioning equipment triggers duct sealing and leakage testing, and other requirements as described below.

The duct system connected to the altered equipment must be sealed by the installer and verified by a HERS Rater as specified in RA3.1 under any of the following conditions:

1. An air handler is replaced.
2. An outdoor condensing unit of a split system air conditioner or heat pump is installed or replaced.

3. A packaged system is completely replaced.
4. A cooling or heating coil is installed or replaced.

The measured duct leakage must be equal to or less than 10 percent of the system airflow, or the measured duct leakage to outside must be equal to or less than 7 percent of the system airflow. If it is not possible to meet either of these duct leakage targets (which must be performed first), then all accessible leaks must be sealed and verified through a visual inspection and a smoke test by a HERS rater.

There are a few cases where duct sealing and duct leakage verification are not required. These exceptions include:

1. Ducts that have already been sealed, tested, and certified by a HERS Rater.
2. Duct systems with a total less than 40 feet of duct; and
3. Duct systems that contain asbestos. See Blueprint Issue 130, Q&A: Residential Duct Testing.

Additionally, when altered ducts, air-handling units, cooling or heating coils, or plenums are located in a garage, the ducts must be sealed by a HERS rater to a measured duct leakage of 6 percent or less of the system airflow. The alternative to this is having all accessible leaks located in the garage space sealed and verified through a visual inspection and a smoke test by a HERS rater. This requirement applies when any length of new ducts is installed (not limited to 25 feet of ducts).

When performing a visual inspection and smoke test, sampling is not allowed. The HERS rater must perform the inspection and test on every house. Some judgement is required in determining if ducts are accessible, where the local enforcement agency will have the final say when it is not immediately obvious.

In Climate Zones 2 and 8 through 15, when a refrigerant-containing component of an air conditioner or heat pump is replaced or installed in an existing house, §150.2(b)1F requires a system that does not have a fault indicator display (FID) installed to have refrigerant charge field verified (RCV) in accordance with all applicable procedures specified in RA3.2.2, or RA1. When RCV is required for compliance, the system must also comply with the minimum airflow of 250 cfm/ton for small duct high velocity systems and 300 cfm/ton for all other systems, according to the procedures specified in RA3.3.

For all climate zones, when an existing system has a refrigerant containing component added or replaced the thermostat must be upgraded to a digital setback type that meets §110.2(c)

If the space heating system is being replaced, the replacement system must not use electric resistance as the primary heat source unless one of the following exceptions is met:

1. The existing system is electric resistance, and the replacement system is nonducted.
2. The existing system is electric resistance, and a ducted space cooling system is not being replaced or installed.
3. The existing system is electric resistance and located in Climate Zone 7 or 15.

---

**Example 9-31****Question:**

Do I have to seal the ducts if I replace the outdoor units in my house without changing the indoor unit?

**Answer:**

Yes. Replacing the outdoor unit (or indoor unit) by itself will trigger the duct sealing and verification requirement. The alteration requirements differ from newly constructed building requirements. (See §150.2[b]1Ei through iii for the requirements and exceptions.)

**Example 9-32****Question:**

I have an existing electric furnace and I'm adding a new bedroom. Can I extend the existing ducts to the new room and use the existing furnace?

**Answer:**

Yes. If ducts are extended (of any length) from an existing space-conditioning system, compliance requires meeting the mandatory duct requirements, and the additional prescriptive duct insulation and duct sealing and leakage testing requirements. The existing furnace must also have adequate heating capacity to meet California Building Code requirements for the additional space.

**Example 9-33****Question:**

I am adding a bedroom to a house that has a central forced-air natural gas furnace. I would like to heat the room with an electric resistance baseboard heater rather than extend the existing ductwork to reach the new space. Is this allowed?

**Answer:**

Not using prescriptive compliance. This is only possible if using performance compliance and the relatively high energy consumption of the electric resistance heater is made up by reductions from other energy efficiency features in the addition or in an accompanying alteration.

**Example 9-34****Question:**

My central gas furnace stopped working. If I get a new efficient unit rather than repair the existing one, what are the requirements?

Answer:

Mandatory requirements apply to the components being replaced. The furnace must meet minimum efficiency requirements, but all systems sold in California should already meet the minimum efficiency requirements. If the new system includes mechanical cooling, and the existing thermostat is not a setback thermostat, it must be replaced with a setback thermostat (§150.2[b]1Fi).

All new ducts must meet insulation and construction requirements. All existing and new ducts must be sealed and HERS-verified, as specified §150.2(b)1E.

Prescriptively, the new heating unit must be natural gas fueled or a heat pump. A CF1R-ALT-02 can be completed by you or your mechanical contractor and registered on a HERS Provider's website.

### **Example 9-35**

#### **Question:**

As part of an upgrade in an existing house, one of the ducts is being replaced because of deterioration of the insulation. What requirements apply to the replacement duct?

Answer:

This is an alteration to the space-conditioning system; therefore, the mandatory requirements for ducts apply. If more than 25 feet of the duct is altered, the requirements of §150.2(b)1D trigger diagnostic testing and HERS verification of the duct system, as well as the prescriptive duct insulation requirements.

### **Example 9-36**

#### **Question:**

An upflow air-handling unit with a furnace and air conditioning coil is located on a platform in the garage of an existing house. The platform is used as a return air plenum. The air-handling unit is being replaced, and the platform is being repositioned to the corner of the garage (three feet away from the current location). What requirements apply to this alteration?

Answer:

The mandatory requirements apply to this alteration. In particular, §150.0(m) prohibits raised platforms or building cavities from being used to convey conditioned air (including return air and supply air). When the platform is relocated, it is being altered, and the mandatory requirement applies. Ducts made from sheet metal, duct board, or flexible ducts must be installed to carry the return air to the replaced air handler.

Since the air handler is being replaced the prescriptive duct sealing requirements of §150.2(b)1D and E, which apply to ducts in garage spaces, would require either 6 percent duct leakage or a visual inspection and smoke test. (See Section **Error! Reference source not found.**)

### **Example 9-37**

#### **Question:**

What is meant by the term "air handler"?

#### **Answer:**

The term "air handler" is used to identify the system component that provides the central system forced-air movement for the ducted heating or cooling space-conditioning system. The term "air handler" may be properly used to identify various types of central system forced-air-moving components that must meet the functional requirements for different types of space-conditioning systems. For instance, a "gas furnace" air handler includes a gas combustion heat exchanger and the central system fan, but does not include a direct expansion (DX) cooling coil; an "electric furnace" air handler has electric heating coils and the central system fan, but does not include a DX cooling coil; a "fan-coil unit" air handler for a split system heat pump has a DX cooling/heating coil and a central system fan; a "hydronic heat pump" air handler includes the air-side DX coil, compressor, water-cooled condenser, and the central system fan. There are other air handler configuration variations as well.

### **Example 9-38**

#### **Question:**

I have a residential building that was constructed in the 1920s. It has a freestanding gas furnace, and I want to change it to an electric wall heater. Is this permitted?

#### **Answer:**

No. Section 150.2(b)1Cii states that the new space-conditioning system be limited to natural gas, liquefied petroleum gas, or the existing fuel type. The only electric option is a heat pump.

### **Example 9-39**

#### **Question:**

I am replacing only my heat pump equipment. What requirements apply for my duct system?

#### **Answer:**

When a space conditioning system is altered duct sealing requirements are triggered. If the ducts are not being replaced, the existing duct system needs to be tested by the installer and a HERS Rater to have no greater than 10% total leakage or 7% leakage to outside. If this leakage criteria cannot be met, a smoke test and visual verification may be conducted by a HERS Rater to verify that all accessible ducts have been sealed.



**Example 9-40****Question:**

What are the duct sealing requirements if am I replacing or adding 20 feet or more of ducts located in my garage?

**Answer:**

When replacing or adding any length of ducts in garage spaces or altering any space conditioning equipment in a garage (including air-handling units, cooling or heating coils, or plenums) duct sealing requirements apply. Ducts must be tested by the installer and a HERS Rater to have leakage less than or equal to 6% of air handler airflow. If this leakage criteria cannot be met, a smoke test and visual verification may be conducted by a HERS Rater to verify that all accessible ducts have bene sealed.

**Example 9-41****Question:**

I am replacing an existing ducted electric resistance furnace and am installing central A/C, can I install another electric resistance furnace?

**Answer:**

In climate zones 1-6, 8-14, and 16 no. When replacing an existing ducted electric resistance furnace in these climate zones, the only time another ducted electric resistance furnace can be installed is when ducted air conditioning is not being replaced or installed new. Otherwise, a heat pump or gas or propane heating system is required. In Climate Zones 7 and 15 an electric resistance furnace may be installed in this case.

**Question:**

What if I am replacing baseboard electric heating in addition to adding a central A/C system?

**Answer:**

When the replacement heating system is ductless, such as with baseboard heating, this is allowed whenever the existing system is electric resistance.

---

**9.4.7 Mechanical Ventilation for Additions and Alterations**

The whole-dwelling unit ventilation and local mechanical exhaust requirements apply to additions and alterations based on specific conditions as described in this section. See Chapter 4 for details on mechanical ventilation requirements.

**9.4.7.1 Additions**

The whole-dwelling unit ventilation requirements in §150.0(o)1C apply to additions greater than 1,000 square feet and additions that add a new dwelling unit.

- An addition to an existing dwelling unit that increase the conditioned floor area by more than 1,000 square feet must have the required whole-dwelling unit

ventilation airflow calculated by using the entire dwelling unit conditioned floor area. This is the existing conditioned floor area plus the added conditioned floor area.

- An addition that adds a new dwelling unit to an existing building must have the required whole-dwelling unit ventilation airflow calculated by using the conditioned floor area of the new dwelling unit.

Additions less than 1,000 square feet of conditioned floor area and additions that add a junior accessory dwelling unit (JADUs) do not need to meet the whole-dwelling unit ventilation requirements.

When whole-building ventilation airflow is required for compliance, field verification and diagnostic testing of airflow performance are required in accordance with the procedures in Residential Appendix RA3.7. In that case, a Certificate of Compliance CF1R form must be registered online with a HERS Provider. (See Section 2.5 and Appendix A.)

The local mechanical exhaust requirements of §150.0(o)1G and §150.0(o)2 must also be met, as applicable, when a kitchen or bathroom is added as part of an addition.

#### **9.4.7.2 Alterations**

Alterations that install a new or completely replaces an existing ventilation system must comply with all the applicable requirements in §150.0(o). An entirely new or complete replacement ventilation systems is a new ventilation fan component and an entirely new duct system. An entirely new duct system is constructed of at least 75 percent new duct material, and up to 25 percent may consist of reused parts from the dwelling unit's existing duct system if the reused parts are accessible and can be sealed to prevent leakage.

When a whole-dwelling ventilation fan is altered or replaced:

- Dwellings that were previously required by a building permit to comply with whole-dwelling ventilation requirements, are required to comply with the current whole-dwelling ventilation airflow specified in §150.0(o)1C. Field verification and diagnostic testing of airflow performance are required in accordance with the procedures in Residential Appendix RA3.7. In that case, a Certificate of Compliance CF1R form must be registered online with a HERS Provider. (See Section 2.5 and Appendix A.)
- All replacement whole-dwelling unit ventilation fans must be rated for airflow and sound in accordance with ASHRAE 62.2 Section 7.1. When meeting whole-dwelling unit ventilation airflow is required (as described above), the replacement ventilation fan must be rated to deliver an airflow rate that is equal to or greater than the required airflow.

- If the air filtration device is altered or replaced it must comply with the ventilation system air filtration requirements in §150.0(m)12 for dwellings that were previously required by a building permit to comply with the air filtration requirements.

When a local mechanical exhaust system is altered or replaced:

- All altered bathroom local exhaust systems must comply with the applicable requirements of §150.0(o)1G.
- Altered kitchen exhaust systems for dwellings that were previously required by a building permit to comply with the kitchen local exhaust requirements in §150.0(o)1G are required to meet or exceed the applicable airflow or capture efficiency requirements specified in §150.0(o)1G.
- Altered kitchen exhaust systems for dwellings that were previously required by a building permit to install a vented kitchen range hood or other kitchen exhaust fan are required to install a replacement fan that meets or exceeds the airflow required by the previous building permit, or 100 cfm, whichever is greater.
- All replacement local mechanical exhaust fans must be rated for airflow and sound in accordance with ASHRAE 62.2 Section 7.1 and Title 24, Part 6 Section 150.0(o)1Gvi. When meeting an exhaust airflow is required (as described above), the replacement exhaust fan must be rated to deliver an airflow rate that is equal to or greater than the required airflow.

#### **9.4.8 Lighting for Additions and Alterations**

Highlights of the residential lighting requirements are listed below. All residential indoor and outdoor lighting requirements are mandatory. Details of the 2022 Energy Code residential lighting requirements can be found in Chapter 6.

1. Luminaire (light fixture) requirements, see §150.0(k)1 and Table 150.0-A, and Residential Compliance Manual Section 6.2
2. Screw based luminaire requirements, see §150.0(k)1B and Residential Compliance Manual Section 6.2.5
3. Recessed downlight luminaires in ceilings, see §150.0(k)1C and Residential Compliance Manual Section 6.2.3
4. Indoor lighting control requirements, see §150.0(k)2 and Residential Compliance Manual Section 6.3
5. Outdoor luminaires and lighting controls requirements, see §150.0(k)3 and Residential Compliance Manual Section 6.4.1 and 6.4.2
6. Internally illuminated address sign requirements, see §150.0(k)4 and Residential Compliance Manual Section 6.4.3

### 7. Residential garages , see §150.0(k)5, Section 6.5

Altered lighting and any newly installed lighting equipment are required to comply with the residential lighting standards, which apply to permanently installed lighting and associated lighting controls.

Only the lighting equipment that is altered needs to comply with the Energy Code. Existing lighting equipment is not required to be replaced to comply.

---

#### **Example 9-42**

##### **Question:**

I am remodeling and renovating my whole home and putting in an entirely new indoor lighting system. How does the Energy Code apply to the new lighting system?

##### **Answer:**

When an entirely new lighting system is installed, it is treated like required for a newly constructed building. The new indoor lighting system must meet the lighting requirements in §150.0(k)1, Table 150.0-A and 150.0(k)2.

If the remodeling includes any lighting in garages with eight or more vehicles, there are also applicable requirements in §150.0(k)5.

#### **Example 9-43**

##### **Question:**

I am doing minor renovations to my kitchen that has six recessed incandescent cans and I am adding a new luminaire over the sink. How does the Energy Code apply to the new luminaire and the altered luminaires in this case?

##### **Answer:**

The new luminaire and the altered luminaires must meet the luminaire efficacy requirements of Section 150.0(k)1 and TABLE 150.0-A. Where existing screw base sockets are present in ceiling-recessed luminaires, removal of these sockets is not required provided that new JA8 compliant trim kits or lamps designed for use with recessed downlights or luminaires are installed.

#### **Example 9-44**

##### **Question:**

In the kitchen above, I am replacing one of the recessed downlight luminaires. Must the new downlight luminaire be high luminous-efficacy?

##### **Answer:**

Yes, newly installed luminaires must be high luminous-efficacy and meet the requirements in §150.0(k)1 and Table 150.0-A. Screw-based sockets are not permitted for newly installed recessed downlight luminaires in ceilings.

#### **Example 9-45**

**Question:**

I am replacing my incandescent bath bar in the bathroom. Must the new luminaire meet the Energy Code requirements?

**Answer:**

The new luminaire is the altered component and must meet requirements in §150.0(k)1 and Table 150.0-A, including the high luminous-efficacy luminaires and the lighting controls requirements. The 2022 Energy Code now allows the installation of Joint Appendix JA8-compliant lamps in screw-based fixtures as a way to comply with the high luminous-efficacy lighting requirements as long as the luminaire is not a recessed downlight in ceiling. See Sections 6.2 and 6.3 of this manual for details.

---

## **9.5 Performance Approach**

### **9.5.1 Performance: Addition Alone**

With very few exceptions, modeling an addition alone requires meeting the same requirements as newly constructed buildings. Any exceptions for additions are explained in Sections 9.3.1 and 9.3.2.

### **9.5.2 Performance Method: Additions and Existing + Addition + Alterations Approach**

The computer programs used for compliance include requirements from §150.2(a)2B as well as §150.2(b)2A and B to set the standard design budget. Table 9-17 contains the efficiencies used to establish the standard design for a building using existing + addition + alteration (which includes existing + alteration) compliance.

**Table 9-17: Standard Design for Altered Components**

<b>Altered Component</b>	<b>Standard Design Without Third Party Verification of Existing Conditions Shall Be Based On</b>	<b>Standard Design With Third Party Verification of Existing Conditions Shall Be Based On</b>
Ceiling Insulation, Wall Insulation, and Raised-Floor Insulation	The requirements of Sections 150.0(a), (c), and (d)	The existing insulation R-value
Fenestration	U-factor of 0.40 and SHGC value of 0.35. Glass area is existing glass area.	If proposed U-factor is $\leq$ 0.40 and SHGC value is $\leq$ 0.35, standard design is existing U-factor and SHGC values, as verified. Otherwise, standard design is 0.40 U-factor and 0.35 SHGC. Glass area is existing glass area.
Window Film	U-factor of 0.40 and SHGC value of 0.35.	Existing fenestration based on Table 110.6-A and Table 110.6-B.
Doors	U-factor of 0.20. Door area is existing door area.	If proposed U-factor is $<$ 0.20, standard design is existing U-factor, as verified. Otherwise, standard design U-factor is 0.20. Door area is existing door area.
Space-Heating and Space-Cooling Equipment	TABLE 150.1-A or B for equipment efficiency requirements. Section 150.2(b)1C for entirely new or complete replacement systems. Section 150.2(b)1F for refrigerant charge verification requirements.	The existing efficiency levels.
Air Distribution System – Duct Sealing	The requirements of Sections 150.2(b)1D and 150.2(b)1E	The requirements of Sections 150.2(b)1D and 150.2(b)1E
Air Distribution System – Duct Insulation	The proposed efficiency levels.	The existing efficiency levels.
Water Heating Systems	The requirements of Section 150.2(b)1H	The existing efficiency levels.
Roofing Products	The requirements of Section 150.2(b)1H.	The requirements of Section 150.2(b)1H.
All Other Requirements	Proposed efficiency levels.	Existing efficiency levels, as verified.

Source: Table 150.2-D, Energy Code.

The table below summarizes the basic rules for modeling a single-family residential building using the existing + addition + alterations performance approach. For more detailed information, see Section 9.4 or the software user manual.

**Table 9-18: Modeling Rules for Existing + Addition + Alterations**

Type of Component or System Modeled	Standard Design Without Third-Party Verification of Existing Conditions	Standard Design With Third-Party Verification of Existing Conditions
<b>EXISTING – Components or systems to remain unchanged</b>	<b>Model each component or system as “Existing”</b>	<b>Model each component or system as “Existing”</b>
<b>ALTERED—Components or systems being changed or replaced</b>	<b>Model each altered component as “Altered” (prealtered conditions are not modeled)</b>	<b>Model each altered component as “Altered” with prealtered conditions also modeled</b>
<b>NEW—Components or systems being added (did not previously exist)</b>	<b>Model each component or system as “New”</b>	<b>Model each component or system as “New”</b>
<b>REMOVED—Components or systems being removed and not replaced</b>	<b>These components omitted from the model</b>	<b>These components omitted from the model</b>

Source: California Energy Commission

1. **Without** third-party verification of the existing (prealteration) conditions of the building, the E+A+A approach provides credits only once a fairly high threshold is met. See §150.2(b)2B and Table 150.2-D of the Energy Code.
2. **With** third-party verification of the pre-alteration conditions of the building, the E+A+A approach provides full credit for the effect of the altered component. See §150.2(b)2B and Table 150.2-D of the Energy Code.

Energy Commission-approved compliance software is used to model the building as explained in Chapter 8 or the software user manual. Whichever compliance path is selected, the Certificate of Compliance (CF1R) generated by the software must be submitted for permit. If the CF1R includes energy requirements that require HERS testing or verification, the CF1R must also be registered online with a HERS Provider before it is submitted for permit. See Chapter 2 of this manual.

### 9.5.3 Existing + Addition + Alterations Without Third-Party Verification

The existing building with all alterations is modeled together with the addition and **existing** conditions are not verified by a third-party HERS Rater. Under this performance path, the building is modeled as follows:

1. Addition: All new components of the addition and all new systems serving the addition are modeled, including roof/ceilings, skylights, exterior walls, glazing (fenestration), raised floors and slab floors, HVAC equipment, ducts, and water heating. Only HVAC equipment and water heating may be existing. All other components are “new.”
2. Existing Components to Remain Unchanged: Existing components and systems to remain are modeled and tagged within the compliance software as “existing.”
3. Existing Components to Be Altered or Replaced: Each altered component (i.e., a new component that replaces an existing component) is modeled as “altered.” For example, a new water heater that replaces an existing water heater is

labeled "altered," while a water heater that supplements an existing water heater is labeled "new." Since verification of existing conditions is not being used, no "existing" conditions are specified.

4. Existing to Be Removed: These features are not modeled.

*Note:* Portions of new fenestration including skylights that will occur in the existing opening of fenestration to be replaced are tagged "altered." Portions of new fenestration that will occur where there is no existing fenestration opening are labeled "new."

#### **9.5.4 Existing + Addition + Alterations With Third-Party Verification**

The existing building with alterations is modeled together with the addition(s) in the same manner as above. Any altered components that are tagged to be verified by a third-party HERS Rater must be verified before permit application is made or construction begins. The standard design that sets the energy budget may, depending on the energy efficiency of the altered component or system, be based on the prealtered existing conditions.

#### **9.5.5 Existing + Addition + Alterations as Newly Constructed Buildings**

A rarely used option is to model Existing + Addition + Alterations as all "new" components. The compliance software sets the energy budget as if the project were an entirely new building.

#### **9.5.6 Summary of Modeling Rules**

Table 9-18 summarizes the basic rules for compliance software users analyzing a residential addition or alteration using the Existing + Addition + Alterations approach. For further information, see the specific compliance software user's manual for details on how to input data correctly.

---

#### **Example 9-46**

##### **Question:**

A 1,600 ft<sup>2</sup> house built in 1980 in Climate Zone 12 is being renovated as follows:

1. A 500 ft<sup>2</sup> room will be added, including 120 ft<sup>2</sup> of new windows.
2. A 200 ft<sup>2</sup> wall and 100 ft<sup>2</sup> of old window will be removed.
3. Attic insulation in the existing house will be upgraded to R-38.
4. The addition will be connected to the existing HVAC and duct system.

If the performance approach is used to demonstrate compliance, how does the compliance software establish the standard and proposed designs?

##### **Answer:**



Table 9-18 summarizes the Modeling Rules for Existing + Addition + Alterations, which must be followed to have the compliance software accurately set the standard design and model the proposed design. Under the performance rules, the removed wall and window are not included in the energy model and have no effect. The standard design for the added conditioned floor area is set using the prescriptive requirements of §150.1(c). If the existing duct system is extended by 25 linear feet or more, the standard design assumes duct alterations with 10 percent duct leakage requirements.

The standard design assumptions for the existing house follow the rules summarized in §150.2(b)2 and Table 150.2-D based on whether there is third-party verification of the existing conditions. Without third-party verification, upgraded energy components in the existing house are modeled as fixed assumptions that represent reasonably expected levels of efficiency for each altered component. If optional third-party verification is selected for the components in the existing house that are to be upgraded, the standard design assumes the existing conditions specified by the software user. These features must be verified before construction begins and before application of the permit.

The standard design assumptions for the 500 ft<sup>2</sup> addition is based on the features of §150.1(c), Table 150.1-A.

The existing space conditioning system, as defined by the software user, is modeled in both the standard and proposed design. The duct system is made up of new ducts as an extension of the existing ducts.

### Example 9-47

#### Question:

For the 1980 house in the examples above, an operable single-pane metal window is replaced with a 0.55 U-factor window. Does this alteration result in a compliance credit? How about the case where the existing window is replaced with a window that has a U-factor of 0.35?

#### Answer:

As explained in Example 9-42, altered components that receive compliance credit must exceed the requirements of Table 150.2-D. Windows in the addition must have a U-factor of  $\leq 0.30$  and SHGC  $\leq 0.23$  to receive credit (Climate Zone 12). Replacement windows in the existing house must have a U-factor of  $\leq 0.40$  and SHGC  $\leq 0.35$  to receive credit.

A window replacement with a 0.55 U-factor will receive a penalty compared with a 0.40 U-factor standard design assumption for that window. **Without** third-party verification of existing conditions, a 0.35 U-factor window replacement will receive a credit compared with a 0.40 U-factor standard design assumption for that window. **With** third-party verification of existing conditions, either window replacement will receive a credit as compared with a 1.28 U-factor standard design assumption for an operable single-pane metal existing window.

Although this example describes a window alteration, the same principles apply to other building systems, such as other building envelope components, as well as HVAC and water-heating equipment.

**Example 9-48****Question:**

An addition of 590 ft<sup>2</sup> is being added to a 2,389 ft<sup>2</sup> single-family house. How do you demonstrate compliance using the Existing + Addition + Alterations method?

**Answer:**

The steps are the following:

1. Collect accurate envelope and mechanical information about the addition and existing building from scaled drawings (plans, sections, and elevations); determine what components, (HVAC, ducts, water heating, etc.) are being altered as part of the permitted scope of work.
2. Enter the information about the addition and the existing building into the compliance software program, identifying each modeled feature as "existing," "altered," or "new," as summarized in Table 9-18. Proper identification of these inputs is critical to correctly and accurately determining compliance.
3. Run the compliance software to determine if the proposed building TDV energy is equal or less than the standard design TDV energy.
4. If the project does not comply, modify the energy features of the addition and/or the existing building until compliance is achieved.
5. If features of the existing building are being modified, consider the option of verifying existing conditions. When using this option, this inspection by a HERS Rater must be completed before construction begins and before the project registration (Step 6) can be completed.
6. All projects that include energy features requiring HERS field verification and diagnostic testing, which represent almost all buildings under the 2022 Energy Code, must be registered online with a HERS Provider as explained in Section 2.3 in order to obtain a valid CF1R to apply for a permit.
7. Print the registered CF1R for permit application submittal.

**Example 9-49****Question:**

When using the existing-plus-addition performance approach, do the mandatory requirements, including airflow, watt draw measurement, etc. (§150.0[m]13) need to be met for space-conditioning equipment serving an addition? What about the prescriptive requirement for refrigerant charge verification (or one of the alternatives to §150.1[c]7)?

**Answer:**

If existing equipment is extended to serve the addition, these space conditioning requirements do not need to be met as specified by Exception 4 to §150.2(a). However, Exception 5 to §150.2(a) requires a duct system that is extended be sealed, tested, and HERS verified according to §150.2(b)1D.

If an entirely new or complete replacement system is installed to serve the addition, it must meet the requirements of §150.2(b)1C. When the new equipment is designed to serve the existing house and the addition, it is an alteration and must meet the requirements of §150.2(b). The duct sealing, testing, and verification requirements of §150.2(b)1E must also be met. Refrigerant charge verification is not a mandatory requirement. However, if the project is in Climate Zone 2 or 8-15, there is a compliance penalty if refrigerant charge verification is not modeled.

**Example 9-50****Question:**

When using the E+A+A performance method, can compliance credit be gained by sealing the existing ducts when it was not required for prescriptive compliance?

**Answer:**

No. Once the status of the ducts is "altered" the standard design assumes the duct sealing is required.

**Example 9-51****Question:**

When using the existing-plus-addition performance compliance method, can credit be gained by installing a radiant barrier in the existing house attic?

**Answer:**

No. Once the attic/roof is "altered" the standard design becomes equivalent to Table 150.1-A or B

**Example 9-52****Question:**

I am adding a room to and altering an existing building in Climate Zone 12. I am upgrading an existing single-pane clear glass window with a U-factor of 1.2 and SHGC of 1.0 to a dual-pane window with a U-factor of 0.50 and SHGC of 0.45. Do I receive credit toward the addition compliance for installing this window?

**Answer:**

No, Without third-party verification of the existing building features, there will be a penalty toward achieving compliance since the window is not as efficient as required by Table 150.2-D for Climate Zone 12, which requires a U-factor of 0.40 and an SHGC of 0.35. The penalty for the U-factor is based on the difference between 0.40 and 0.50 and for the SHGC is based on the difference between 0.35 and 0.45. If fenestration is installed that exceeds the performance of the values in Table 150.2-D, then credit is available.

**Example 9-53****Question:**

I am planning to install R-19 insulation in the attic of an existing house built in 1970. Can I use this added insulation as a credit for trading with the energy features of an addition?

**Answer:**

No. When insulation is added to an attic, it must comply with §150.0(a), which sets a mandatory minimum for attic insulation of R-38. Since R-38 is a mandatory minimum, a lower insulation cannot be installed.

**Example 9-54****Question:**

I am planning to install R-25 insulation in an uninsulated vaulted ceiling without an attic space in an existing house built in 1970. Can I use this added insulation as a credit for trading with the energy features of an addition?

**Answer:**

Only if you choose verified existing conditions (see Example 9-44), and even then, it will depend on the climate zone. Because the prescriptive approach has no provision for vaulted roofs, once the roof is altered, the standard design becomes an attic/roof meeting Option B. If Option B has no below roof deck insulation, it is possible to get credit for insulating an uninsulated vaulted roof to R-25.

---

## Table of Contents

10.	Electric Ready Requirements .....	2
10.1	Overview .....	2
10.2	What’s New in 2022 .....	2
10.3	Mandatory Requirements §150.0(n) and §150.0(t-v) .....	2
10.3.1	Water Heater .....	3
10.3.2	Space Heater .....	4
10.3.3	Cooktops .....	5
10.3.4	Clothes Dryer .....	5
10.3.5	Gas Uses not Covered by Electric Ready Requirements .....	6
10.4	Compliance and Enforcement .....	6

---

## 10. Electric Ready Requirements

---

### 10.1 Overview

Sections §150.0(n) and §150.0(t-v) describe the mandatory requirements for electric readiness in single family buildings. The electric readiness requirements apply when natural gas or propane equipment is installed for space heating, water heating, cooking or clothes drying. The intent of the requirements is to facilitate future installations of high efficiency electric equipment and minimize future retrofit costs when gas appliances are replaced with electric appliances.

This section outlines how to comply with the new mandatory electric ready requirements for space heating, water heating, cooking, and laundry.

---

### 10.2 What's New in 2022

Electric-readiness is a new mandatory requirement for gas space heating, cooking, and clothes drying for the 2022 Energy Standards. The electric-ready requirements for gas water heaters have been revised and expanded.

---

### 10.3 Mandatory Requirements §150.0(n) and §150.0(t-v)

Electric readiness requires the following for the applicable gas appliances listed in Table 10-1.

Table 10-1 summarizes the electrical capacity, panel, and other requirements for electric-readiness for each gas appliance installed in a new single family building. There are no electric ready requirements for additions or alterations. There are no performance or prescriptive electric ready requirements for single family buildings.

These requirements are for newly constructed buildings and are not applicable to additions or alterations. Moreover, these requirements are not applicable when electric equipment is installed.

**Table 10-1: Summary of Compliance Requirements**

<b>Gas or Propane Equipment Installed</b>	<b>Electrical Capacity requirements for new circuit (amps, volts)</b>	<b>Panel requirements</b>	<b>Other Requirements</b>
Water heater §150.0(n)	1. 125V, 20 amp receptacle with copper 120V/240V, 10 AWG, 3-conductor wire. Unused conductor shall be labeled and electrically isolated.  OR  2. 240V, 30 amp dedicated circuit	1. Reserved space (labeled "For Future 240V use") for single pole circuit breaker adjacent to 125V, 20A circuit breaker.  OR  2. Reserved space (labeled "For Future 240V use") for double pole circuit breaker	A designated space for a future HPWH (2.5 ft x 2.5 ft wide x 7 ft high)  Condensate drain no more than 2 inches higher than the base of installed water heater to allow for natural drainage without pump assistance
Furnace §150.0(t)	240V, 30 amp	Reserved space for double pole circuit breaker	n/a
Range §150.0(u)	240V, 50 amp	Reserved space for double pole circuit breaker	n/a
Clothes dryer §150.0(v)	240V, 30 amp	Reserved space for double pole circuit breaker	n/a

### 10.3.1 Water Heater

The following mandatory requirements apply to gas or propane water heaters serving single family buildings. These requirements make it easier for someone to retrofit existing water heater with a HPWH in the future. Wiring for a future HPWH during initial construction stage is much less costly than trying to retrofit it later.

### **10.3.1.1 Designated Space**

A designated space needs to be reserved for installation of a future HPWH. That space needs to be 2.5 feet wide by 2.5 feet deep by 7 feet tall. This space can be located where the gas or propane water heater is installed. If there is not adequate space at the installed water heater location, then another suitable location should be identified.

### **10.3.1.2 Electrical Requirements**

The goal of this requirement is to allow easy installation of a HPWH, which typically require a 240V circuit, when the existing gas water heater is replaced.

If the designated HPWH space is within 3 feet of the gas water heater, a dedicated 125-volt (V), 20 amp electrical receptacle shall be installed that is within 3 feet of the water heater and accessible to the water heater with no obstructions. The wiring to this dedicated receptacle shall be connected to a 120/240V, three conductor, minimum 10 AWG branch circuit. The ends of the unused conductor must be labeled as "spare" and be electrically isolated.

Additionally, a reserved single pole circuit breaker space must be placed in the electrical panel next to the circuit breaker for the branch circuit and labeled with the words "Future 240V Use."

If the designated HPWH space is more than 3 feet from the gas water heater, a 240V branch circuit must be installed rated at a minimum of 30 amps with no obstructions, in addition to a dedicated space in the main service panel for a future double pole breaker that will serve the future HPWH. The dedicated space in the panels shall be identified as "Future 240V Use". The circuit shall be dedicated to future electric replacement equipment and cannot be used for other appliances.

### **10.3.1.3 Condensate Drain**

A condensate drain must be placed near the water heater no higher than 2 inches above the base of the tank. This will allow for gravity flow of the condensate without relying on a sump pump.

### **10.3.1.4 Hot and Cold Water Supply**

If the designated HPWH space is more than 3 feet from the gas water heater, both cold water and hot water supply piping, exposed and readily accessible to serve a future HPWH, must be provided at the designated HPWH location. The location shall have a dedicated cold water supply, or a cold water supply shall pass through the designated location before reaching the gas water heater. Hot water supply from the gas water heater must be routed to the designated HPWH location first before serving any of the hot water fixtures in the house.

## **10.3.2 Space Heater**

When gas furnaces are installed, the following electric-ready requirements must be met.



1. Installation of branch circuits within 3 feet of the gas furnace with no obstructions. The circuit shall be 240V rated at a minimum of 30 amps. The circuit shall be dedicated to future electric replacement equipment and cannot be used for other appliances. A receptacle is not required, but the unused circuits must have a blank cover identified as "240V ready". Other electrical components must be installed in accordance with the *California Electrical Code*.
2. Dedicated space in the main service panel for a double pole breaker that will serve the future space heating. The dedicated space in the panels shall be identified as "Future 240V Use." The code does not require the installation of breakers at time of construction.

If gas equipment other than a furnace is installed these electric ready requirements do not apply.

### **10.3.3 Cooktops**

When gas cooktops are installed, the following electric-ready requirements must be met. Note that this requirement applies when installing a gas range but is not required for gas ovens when installed as a separate appliance.

1. Installation of branch circuits within 3 feet of the gas cooktop with no obstructions. The circuit shall be 240V rated at a minimum of 50 amps. The circuit shall be dedicated to future electric replacement equipment and cannot be used for other appliances. A receptacle is not required, but the unused circuits must have a blank cover identified as "240V ready". Other electrical components must be installed in accordance with the *California Electrical Code*.
2. Dedicated space in the main service panel for a double pole breaker that will serve the future electric cooktop. The dedicated space in the panels shall be identified as "Future 240V Use." The code does not require the installation of breakers at time of construction.

These electric ready requirements do not apply to stand-alone ovens.

### **10.3.4 Clothes Dryer**

When gas piping to serve a clothes dryer is installed, the following electric-ready requirements must be met.

1. Installation of a branch circuit within 3 feet of and accessible to the dryer location with no obstructions. The circuit shall be 240V rated at a minimum of 30 amps. The circuit shall be dedicated to future electric replacement equipment and cannot be used for other appliances. A receptacle is not required, but the unused circuits must have a blank cover identified as "240V ready". Other electrical components must be installed in accordance with the *California Electrical Code*.

2. Dedicated space in the main service panel for a double pole breaker that will serve the future electric clothes dryer. The dedicated space in the panels shall be identified as “Future 240V Use.” The code does not require the installation of breakers at time of construction.

### **10.3.5 Gas Uses not Covered by Electric Ready Requirements**

Any gas appliances not listed in Table 10-2 are not required to meet the mandatory electric ready requirements. This includes outdoor grills, barbeque pits, fireplaces, and stand-alone ovens.

---

## **10.4 Compliance and Enforcement**

This section describes compliance documentation and field verification requirements related to electric readiness. When a building permit application is submitted to the enforcement agency, the applicant also submits plans and energy compliance documentation.

### **Example 10-1 – HPWH Ready:**

#### **Question:**

I am installing a propane water heater in a garage and the designated future HPWH location is in the same space, do I need to install a dedicated 125V, 20 amp electrical plug connected to a 3-conductor 10 AWG wire?

#### **Answer:**

Yes. Most modern efficient gas water heaters require 125V, 20 amp power to operate. The electric ready requirement is designed to easily convert the installed 120V electrical circuit to 240V, capable of powering a HPWH. If the installed gas water heater does not have an electrical connection, a dedicated 240V, 30 amp circuit can be provided at the designated HPWH location, along with dedicated space in the main panel for a double pole breaker.

### **Example 10-2 – HPWH Ready:**

#### **Question:**

I am installing a split-system HPWH. The storage tank is in an interior closet and is separate from the compressor and evaporator, which is located outside, do I need to meet the electric ready requirements for water heating?

#### **Answer:**

No. If a HPWH is being installed, either split-system or integrated, the electric ready requirements do not apply. They only apply when a gas water heater is being installed.

### **Example 10-3 – HPWH Ready:**

#### **Question:**

I am installing a 120V HPWH, do I need to meet the electric ready requirements for water heating?

**Answer:**

No. If a HPWH is being installed, regardless of the voltage, the electric ready requirements do not apply. They only apply when a gas water heater is being installed.

**Example 10-4 – Electric Cooktop Ready:**

**Question:**

If I am installing a gas range, do I need to meet the electric ready requirements for cooktops?

**Answer:**

Yes. Because your range includes a gas cooktop, the electric ready requirements need to be met.

**Example 10-5 – Electric Clothes Dryer Ready:**

**Question:**

If I am providing both gas piping and a dedicated electrical circuit for the potential for either a gas or electric dryer to be installed by the homeowner, do I need to meet the electric ready requirements at the dryer location?

**Answer:**

If you are installing a dedicated 240V, 30 amp or greater plug for an electric dryer, in addition to a gas stub-out for a gas dryer, you are meeting the electric ready requirements for clothes dryer.

NOTE: For [Documents and User Instructions](https://www.energy.ca.gov/programs-and-topics/programs/building-energy-efficiency-standards/2022-building-energy-efficiency), please visit our website at <https://www.energy.ca.gov/programs-and-topics/programs/building-energy-efficiency-standards/2022-building-energy-efficiency>

## Certificate of Compliance (CF1R) Documents

Type	Abbreviation	Category	Document Description
CF1R-	ADD-01-E	Additions	Prescriptive Additions Less Than 1,000 ft <sup>2</sup>
CF1R-	ADD-02-E	Additions	Prescriptive Additions – Simple NonHERS (paper version)
CF1R-	ALT-01-E	Alterations	Prescriptive Alterations
CF1R-	ALT-02-E	Alterations	Prescriptive Alterations HVAC
CF1R-	ALT-05-E	Alterations	Prescriptive Alterations – Simple NonHERS (paper version)
CF1R-	ENV-02-E	Envelope	Area Weighted Average Calculation Worksheet
CF1R-	ENV-03-E	Envelope	Solar Heat Gain Coefficient (SHGC) Worksheet
CF1R-	ENV-04-E	Envelope	Solar Reflective Index (SRI) Worksheet
CF1R-	ENV-05-E	Envelope	Alternative Default Fenestration Procedure (NA6) Worksheet
CF1R-	ENV-06-E	Envelope	Interior and Exterior Insulation Layers Worksheet
CF1R-	NCB-01-E	Newly Constructed Buildings	Prescriptive Newly Constructed Buildings and Additions Equal to or Greater Than 1,000 ft <sup>2</sup>
CF1R-	PLB-01-E	Plumbing (DHW)	Hydronic Heating System Worksheet
CF1R-	PRF-01-E	Performance	Residential Performance Compliance Method

## **Certificate of Installation (CF2R) Documents**

<b>Type</b>	<b>Abbreviation</b>	<b>Category</b>	<b>Document Description</b>
CF2R-	ADD-02-E	Additions- Non-HERS	Prescriptive Additions, Non-HERS (paper version)
CF2R-	ALT-05-E	Alterations- Non-HERS	Prescriptive Alterations – Simple NonHERS (paper version)
CF2R	ELC-01-E	Electric- NonHERS	ElectricReady
CF2R-	ENV-01-E	Envelope- NonHERS	Fenestration Installation,
CF2R-	ENV-03-E	Envelope- NonHERS	Insulation Installation
CF2R-	ENV-04-E	Envelope- NonHERS	Roofing - Radiant Barrier
CF2R-	ENV-20-H	Envelope-HERS	Building Leakage Diagnostic Test
CF2R-	ENV-21-H	Envelope- HERS	QII - Framing Stage
CF2R-	ENV-22-H	Envelope- HERS	QII - Insulation Installation Stage
CF2R-	LTG-01-E	Lighting- NonHERS	Lighting - Single Family Dwellings
CF2R-	MCH-01-E	Mechanical- NonHERS	Space Conditioning Systems
CF2R-	MCH-02-E	Mechanical- NonHERS	Whole House Fan
CF2R-	MCH-04-E	Mechanical- NonHERS	Evaporative Coolers

# Appendix A Compliance Documents

Type	Abbreviation	Category	Document Description
CF2R-	MCH-20-H	Mechanical-HERS	Duct Leakage Diagnostic Test
CF2R-	MCH-21-H	Mechanical-HERS	Duct Location Verification,
CF2R-	MCH-22-H	Mechanical-HERS	Fan Efficacy
CF2R-	MCH-23-H	Mechanical-HERS	Airflow Rate
CF2R-	MCH-25-H	Mechanical-HERS	Refrigerant Charge Verification
CF2R-	MCH-26-H	Mechanical-HERS	Rated Space Conditioning System Equipment Verification
CF2R-	MCH-27-H	Mechanical-HERS	Indoor Air Quality and Mechanical Ventilation
CF2R-	MCH-28-H	Mechanical-HERS	Return Duct Design and Air Filter Grille Device Sizing According to Tables 150.0-B or C
CF2R-	MCH-29-H	Mechanical-HERS	Duct Surface Area Reduction; R-Value; Buried Ducts Compliance Credit
CF2R-	MCH-30-E	Mechanical-HERS	Ventilation cooling compliance credit
CF2R-	MCH-31-H	Mechanical-HERS	Whole House Fan
CF2R	MCH-32-H	Mechanical-HERS	Kitchen Ventilation
CF2R	MCH-33-H	Mechanical-HERS	Variable Capacity Heat Pump Compliance Credit

Type	Abbreviation	Category	Document Description
CF2R-	PLB-02-E	Plumbing (DHW)-NonHERS	Single Dwelling Unit Hot Water System Distribution
CF2R-	PLB-03-E	Plumbing (DHW)-NonHERS	Pool and Spa Heating Systems
CF2R-	PLB-22-H	Plumbing (DHW)-HERS	HERS Verified Single Dwelling Unit Hot Water System Distribution
CF2R-	PVB-01-E	Photovoltaics-NonHERS	Photovoltaic Systems
CF2R-	PVB-02-E	Photovoltaics-NonHERS	Battery Storage Systems
CF2R-	SRA-01-E	Solar Ready-NonHERS	Solar Ready Areas
CF2R-	SRA-02-E	Solar Ready-NonHERS	Minimum Solar Zone Area Worksheet
CF2R-	STH-01-E	Solar Thermal-NonHERS	Solar Water Heating Systems

## Certificate of Verification (CF3R) Documents

Type	Abbreviation	Category	Document Description
CF3R-	ENV-20-H	Envelope-HERS	Building Leakage Diagnostic Test
CF3R-	ENV-21-H	Envelope-HERS	QII - Framing Stage
CF3R-	ENV-22-H	Envelope-HERS	QII – Insulation Installation Stage
CF3R-	EXC-20-H	Existing Conditions	HERS Verification of Existing Conditions for Residential Alterations

# Appendix A Compliance Documents

Type	Abbreviation	Category	Document Description
CF3R-	MCH-20-H	Mechanical-HERS	Duct Leakage Diagnostic Test
CF3R-	MCH-21-H	Mechanical-HERS	Duct Location Verification
CF3R-	MCH-22-H	Mechanical-HERS	Fan Efficacy
CF3R-	MCH-23-H	Mechanical-HERS	Airflow Rate
CF3R-	MCH-25-H	Mechanical-HERS	Refrigerant Charge Verification
CF3R-	MCH-26-H	Mechanical-HERS	Rated Space Conditioning System Equipment Verification
CF3R-	MCH-27-H	Mechanical-HERS	Indoor Air Quality and Mechanical Ventilation
CF3R-	MCH-28-H	Mechanical-HERS	Return Duct Design and Air Filter Device Sizing According to Tables 150.0-B or C
CF3R-	MCH-29-H	Mechanical-HERS	Duct Surface Area Reduction; R-value; Buried Ducts Compliance Credit
CF3R-	MCH-31-H	Mechanical-HERS	HERS Verified Whole House Fan
CF3R-	MCH-32-H	Mechanical-HERS	Kitchen Ventilation
CF3R	MCH-33-H	Mechanical-HERS	Variable Capacity Heat Pump Compliance Credit
CF3R-	PLB-22-H	Plumbing (DHW)-HERS	HERS Verified Single Dwelling Unit Hot Water System Distribution



## Appendix B

All energy calculations used for compliance with the Energy Standards must use the climate zone applicable to a building project is determined based on its physical location as it relates to the determinations of climate regions found in the California Energy Commission publication California Climate Zone Descriptions, which contains detailed survey definitions of the 16 climate zones.

The [list of climate zone areas by ZIP code](#) is located on the CEC website here:

<https://www.energy.ca.gov/programs-and-topics/programs/building-energy-efficiency-standards/climate-zone-tool-maps-and>

CEC has also developed an interactive climate zone lookup tool that allow user to locate climate zone by address or ZIP code. The [lookup tool](#) is located here:

<http://caenergy.maps.arcgis.com/apps/webappviewer/index.html?id=4831772c00eb4f729924167244bbca22>

Figure 100.1-A: California Climate Zones

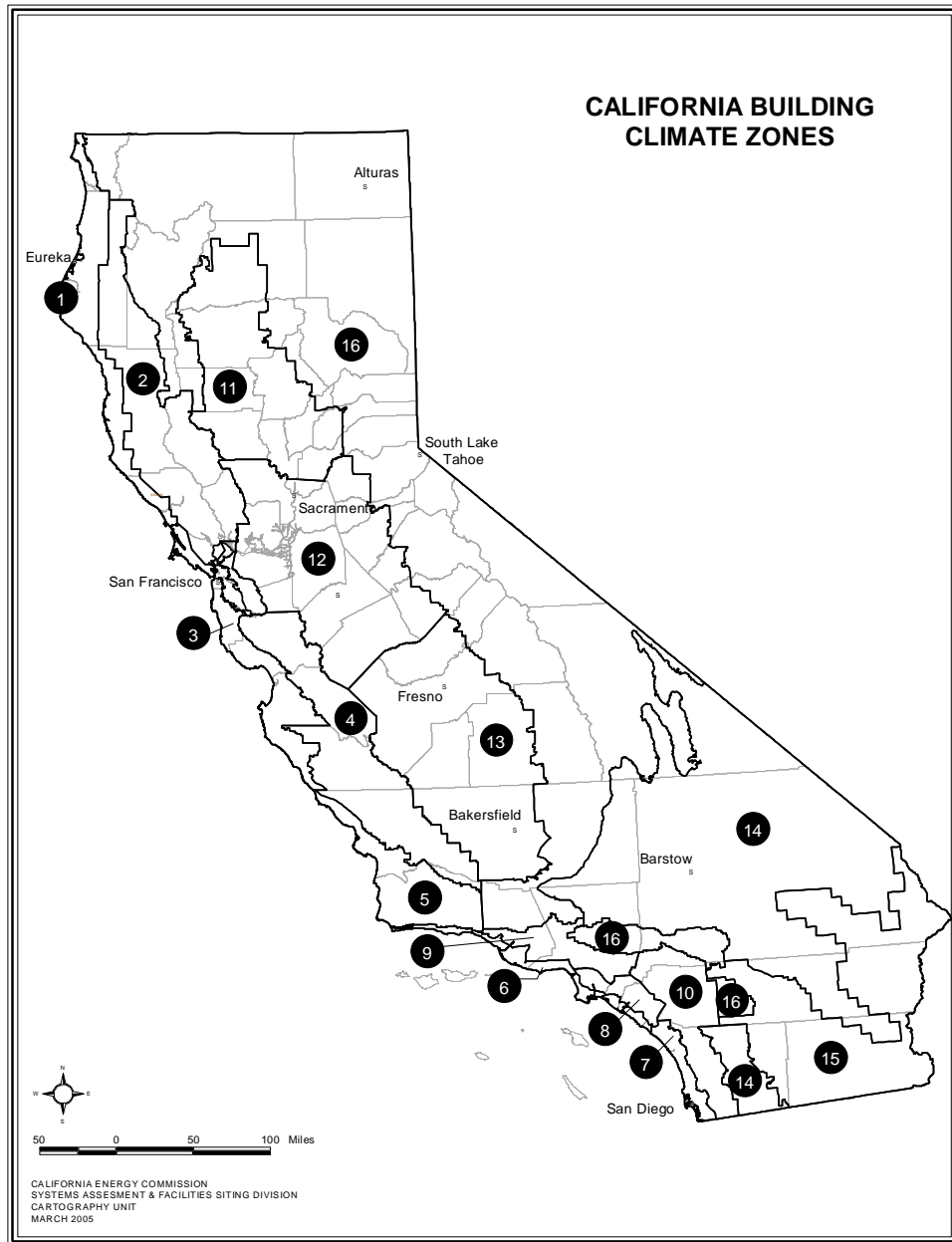

Source: California Energy Commission

---

## Table of Contents

Appendix C .....1

**C1 RESERVED 1**

# Appendix C

RESERVED

---

**C1**      **RESERVED**

## Appendix D – Eligibility Criteria for Radiant Barriers, Section RA4.2.1

Radiant barriers shall meet specific eligibility and installation criteria to be modeled by any approved compliance software and receive energy credit for compliance with the Building Energy Efficiency Standards for low-rise residential buildings.

The emittance of the radiant barrier shall be less than or equal to 0.05 as tested in accordance with ASTM C1371 or ASTM E408.

Installation shall conform to ASTM C1158 (Standard Practice for Installation and Use of Radiant Barrier Systems [RBS] in Building Construction), ASTM C727 (Standard Practice for Installation and Use of Reflective Insulation in Building Constructions), ASTM C1313 (Standard Specification for Sheet Radiant Barriers for Building Construction Applications), and ASTM C1224 (Standard Specification for Reflective Insulation for Building Applications), and the radiant barrier shall be securely installed in a permanent manner with the shiny side facing down toward the interior of the building (ceiling or attic floor). Moreover, radiant barriers shall be installed at the top chords of the roof truss/rafters in any of the following methods:

- (a) Draped over the truss/rafter (the top chords) before the upper roof decking is installed.
- (b) Spanning between the truss/rafters (top chords) and secured (stapled) to each side.
- (c) Secured (stapled) to the bottom surface of the truss/rafter (top chord). A minimum air space shall be maintained between the top surface of the radiant barrier and roof decking of not less than 1.5 inches at the center of the truss/rafter span.
- (d) Attached (laminated) directly to the underside of the roof decking. The radiant barrier shall be laminated and perforated by the manufacturer to allow moisture/vapor transfer through the roof deck.
- (e) In addition, the radiant barrier shall be installed to cover all gable end walls and other vertical surfaces in the attic.

### **For Prescriptive Compliance: The attic shall be ventilated to:**

- (a) Provide a minimum free ventilation area of not less than one square foot of vent area for each 300 ft<sup>2</sup> of attic floor area.
- (b) Provide no less than 30 percent upper vents.
- (c) Ridge vents or gable end vents are recommended to achieve the best performance. The material should be cut to allow for full airflow to the venting.

- (d) The product shall meet all requirements for California certified insulation materials (radiant barriers) of the, Bureau of Household Goods and Services (BHGS), as specified by CCR, Title 24, Part 12, Chapter 12-13, Standards for Insulating Material.
- (e) The use of a radiant barrier shall be listed in the Special Features and Modeling Assumptions listings of the Certificate of Compliance and described in detail in the Residential ACM Manual Conform to the radiant barrier manufacturer's instructions.

# **Appendix E**

## **NATURAL GAS APPLIANCE TESTING (NGAT) STANDARDS**

The NGAT standards, "Natural Gas Appliance Testing (NGAT) Standards", are found in Section 24 of the "California Installation Standards" manual; edition dated July 1, 2012. A copy may be obtained from contacting:

James E. O'Bannon

Richard Heath and Associates

1390 Ridgewood Drive, Suite 10

Chico, CA 95973

Phone: (530) 892-2460

Fax: (530) 892-2825

email: [jim@rhainc.com](mailto:jim@rhainc.com)

Internet: [Richard Heath and Associates](https://www.rhainc.com/index.php/contact-us/) at <https://www.rhainc.com/index.php/contact-us/>

# Appendix F

## Field Verification of Zonally Controlled Systems

*References: §150.0(m)13C, §150.1(c)13, JA1: Glossary: ZONAL CONTROL, RA 3.1.4.6*

### F1.1 Introduction and Scope

Zonally controlled systems are usually installed primarily for improved comfort, not improved energy consumption. Studies have shown that zonally controlled cooling systems that utilize bypass ducts or that substantially reduce the airflow across the coil when zone dampers close can actually use more energy. Because of this, HERS raters are required to evaluate these systems to ensure that it is consistent with what was modeled and what appears on the CF1R.

One type of zonally controlled forced air system utilizes motorized zone dampers in the supply ducts to send supply air from a single air handler to different zones, as needed, rather than sending air to the entire area served by that system. These require multiple thermostats or temperature sensors in each of the zones. The number of zones can be two or more. Two-zone systems are by far the most common. The most common application of this type of system is in two story homes served by a single forced air system. The tendency for air to stratify, along with substandard duct design, causes comfort issues that can often be overcome by zonal control.

Note that dampers may also be installed on the return ducts but are not required for the system to be considered a zonally controlled system.

Problems with this type of zonally controlled system arise from the excess air pressure that occurs at the air handler fan when one or more of the zone dampers close and restrict airflow to just a portion of the supply duct system. One strategy is to simply let the pressure increase, which substantially reduces airflow across the cooling coil or heat exchanger. Another is to install a bypass duct that allows the excess air to "short circuit" from the supply side back to the return side. This causes problems by sending excessively hot air (heating mode) or excessively cold air (cooling mode) back into the system.

An alternative approach is to send the "excess air" back into conditioned space rather than directly back into the return air. These are not considered bypass ducts if the air has a chance to mix with house air in a way that does not substantially change the return air temperatures. The area in the home where the excess air is sent to is referred to as a "dump zone." These dump zones will generally be over-conditioned by this excess air and are usually unoccupied portions of the home, such as hallways or vaulted ceiling areas above the occupied zones. This design may lose some of the comfort benefits of a zonally controlled system.



Zonal control can be also achieved by using two separate systems, sized appropriately for each zone. These act independently and do not need zone dampers. These also do not require bypass dampers or other strategies to handle the excess air. For example, zonal control can be achieved in a two story home by installing a single system with zone dampers that separately control air to the upstairs and downstairs; or it can be achieved by installing two small systems, one dedicated to the first floor and one to the second floor. Assuming that the house can be adequately served by a single large system, the first approach generally costs less.

If it is discovered that a zonally controlled forced air system is installed but not claimed for credit, it needs to be reported to the HERS provider (registry). Because zonally controlled systems can be an energy penalty, they need to be correctly modeled then installed. The CF1R must be revised to reflect the installed system.

## **F1.2 Summary of Requirements**

Prescriptive compliance approach –

1. Zonally controlled systems are not required, but if installed must meet mandatory airflow and fan efficacy requirements using slightly different test methods than for single speed and variable speed compressors.
2. Bypass ducts/dampers are not allowed.

Performance compliance approach –

1. Zonally controlled systems must be modeled then installed.
2. Bypass dampers are allowed only if modeled and indicated on the CF1R.
3. Dual speed/multi speed condensers may also qualify for a credit (at reduced penalty) and if modeled, must be installed.

Note: when a feature is “modeled” using the performance compliance approach it will appear on the certificate of compliance.

## **F1.3 Identifying Zonally Controlled Systems in the Field**

The following are characteristics of most zonally controlled systems that utilize dampers. Not all of these items need to be apparent for the system to be considered zonally controlled. Final determination may require consulting with the installer, designer and system manufacturer.

1. Motorized or actuated zone dampers on the supply ducts. These can be one or more large dampers in or near the supply plenum or they can be one damper for each supply outlet (register). See Figures 1 through 5.
2. Multiple thermostats or temperature sensors in area served by a single system. The most common two zone systems utilize ordinary thermostats for each zone. Some systems have a single master thermostat with small temperature sensors in each zone.
3. A control board on or near the air handler with low voltage wires going to the thermostats/temperature sensors and to each damper. Low voltage wires will also

connect the control board and the main air handler control board. See photos below.

4. Bypass duct and damper. This will be a duct connecting the supply end directly to the return end. On the supply side it will connect after the coil and before the zone damper(s), usually off of the supply plenum. On the return side, it can either connect directly to the side of the return end of the furnace, near the return end of the furnace in a return plenum, or as far away as a return grill boot. An automatic damper will control airflow through this duct. When all zones are calling for cooling (all zone dampers open), the bypass damper should be fully closed. When one or more zone dampers close, the damper should open partially or fully as needed to reduce the supply plenum pressure. This is commonly achieved by a barometric bypass damper. Barometric dampers are held closed by an adjustable weight. When enough pressure builds up on one side of the damper, it overpowers the weight and opens the damper. See Figure 5. Another strategy is to use a motorized damper.

**Figure 1: Illustration of a two-zone, two-damper duct system with both zones open to supply conditioned air.**

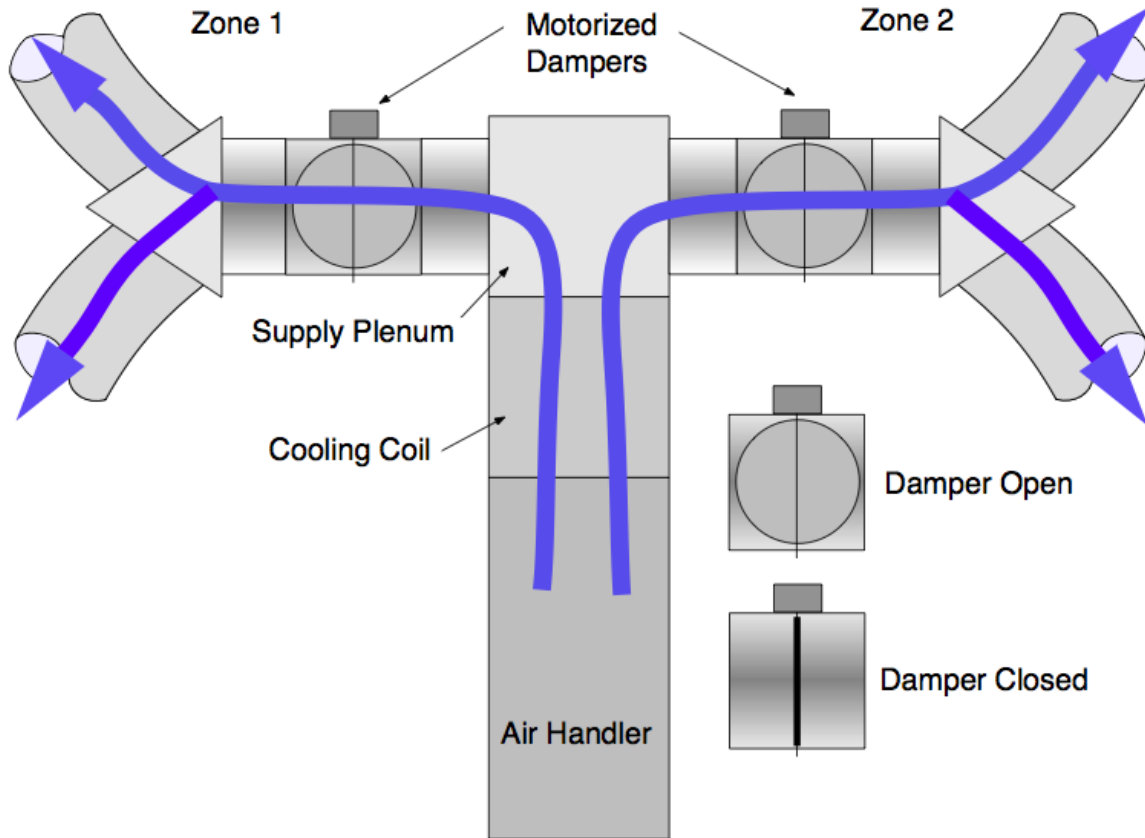

Credit: Russ King, P.E.

**Figure 2: Illustration of a two-zone, two-damper duct system with Zone 2 open to supply conditioned air. The Zone 1 Damper is closed.**

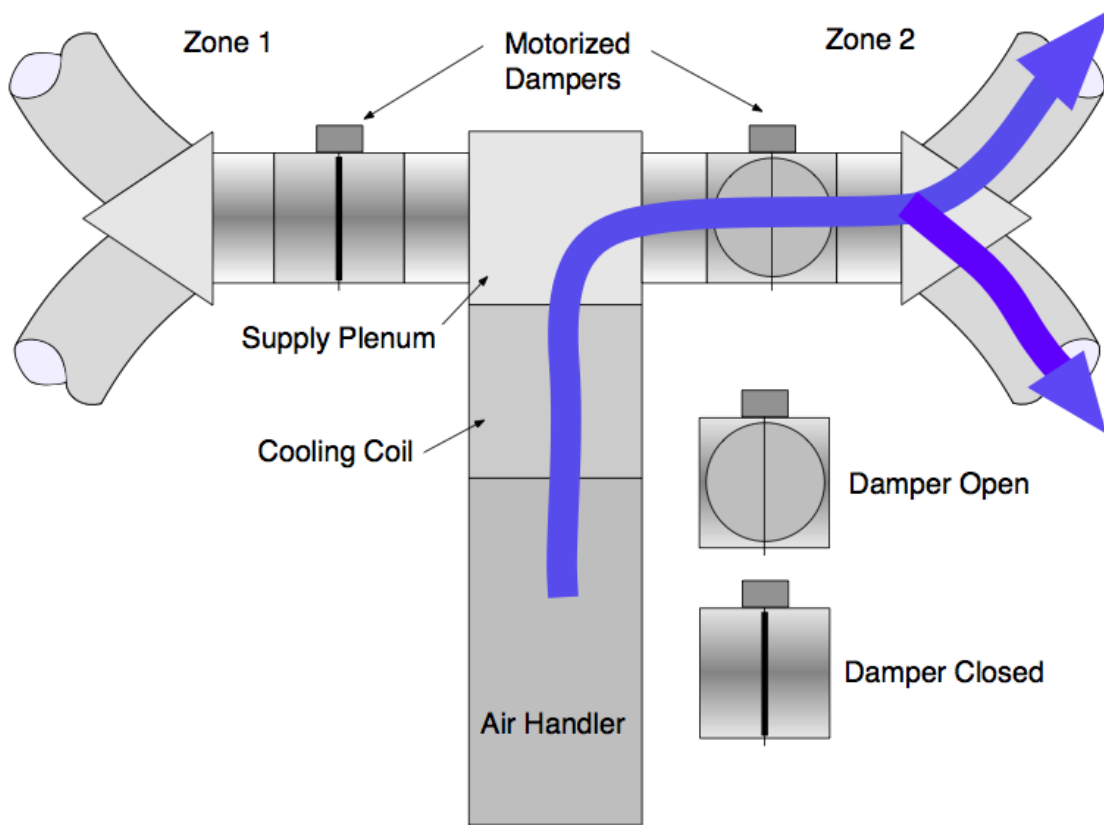

Credit: Russ King, P.E.

**Figure 3: Illustration of a two-zone, single-damper duct system with both zones open to supply conditioned air.**

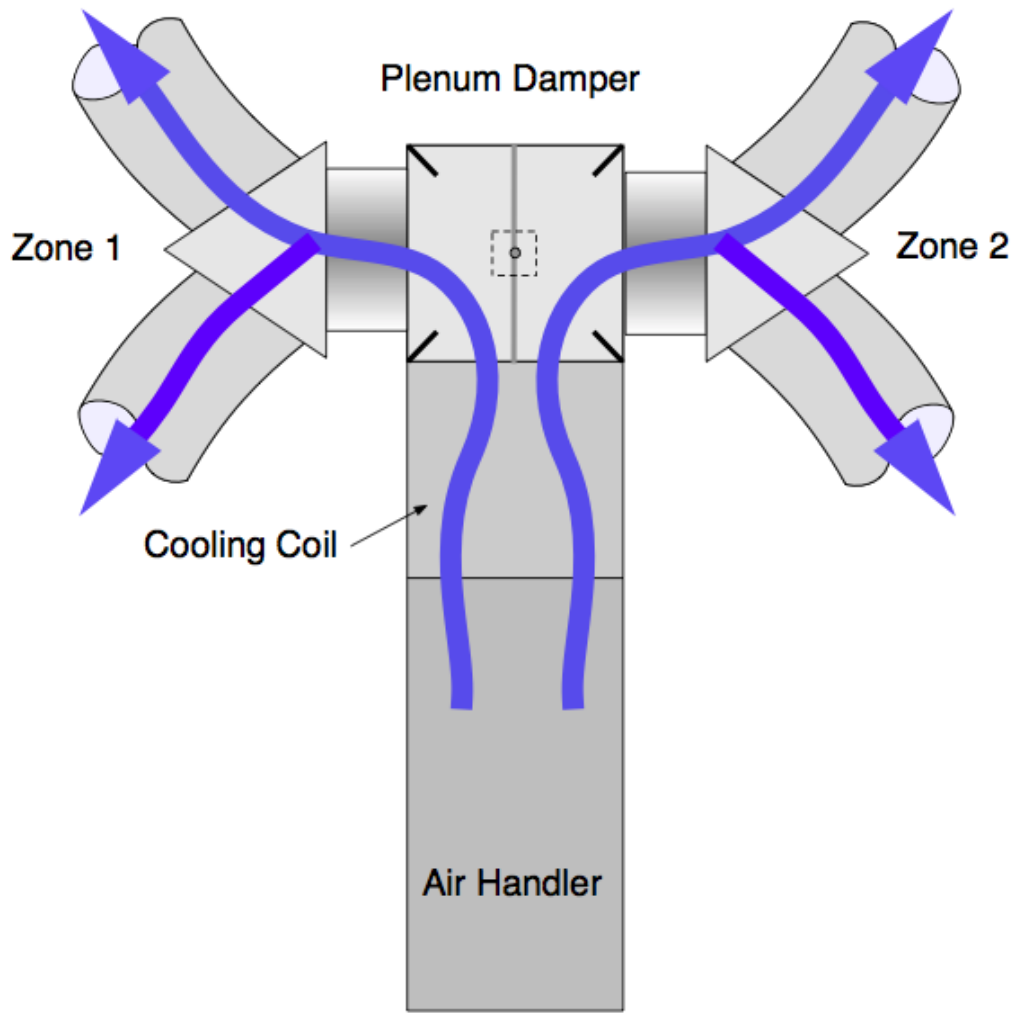

Credit: Russ King, P.E.

**Figure 4: Illustration of a two-zone, single-damper duct system with the damper positioned to supply conditioned air to Zone 1.**

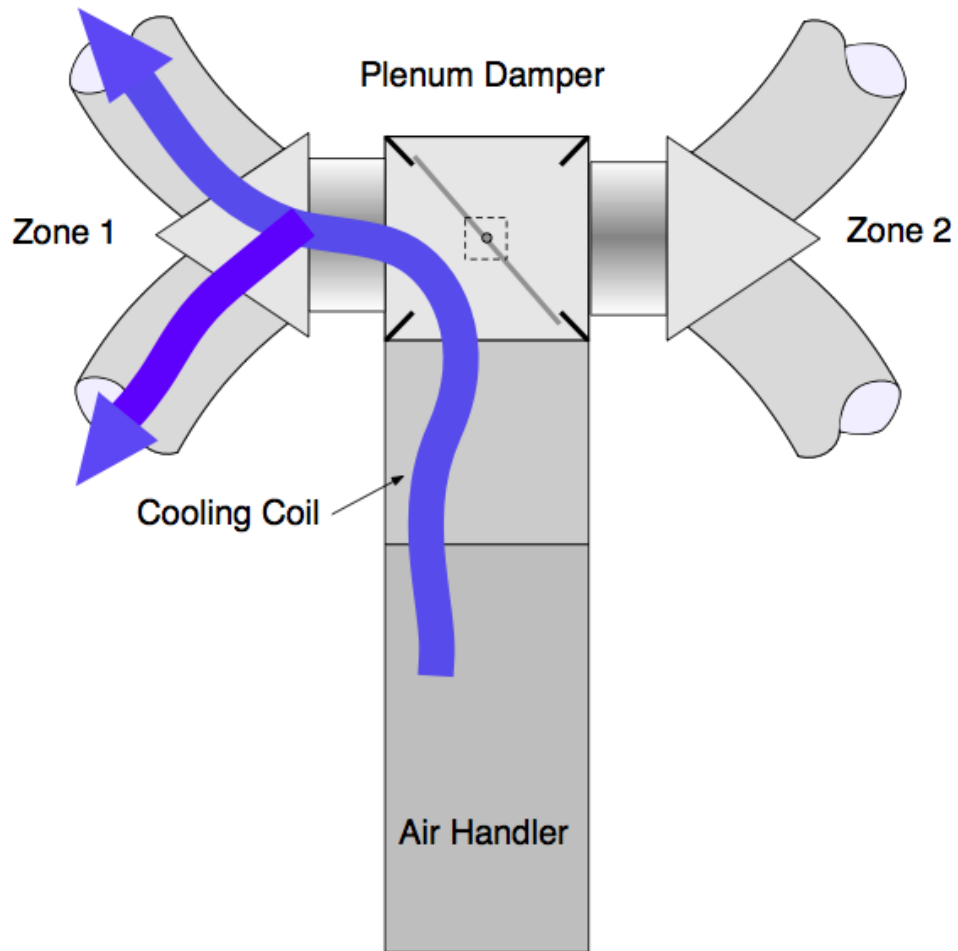

Credit: Russ King, P.E.

**Figure 5: Illustration of a system with a bypass duct and barometric-type bypass damper.**

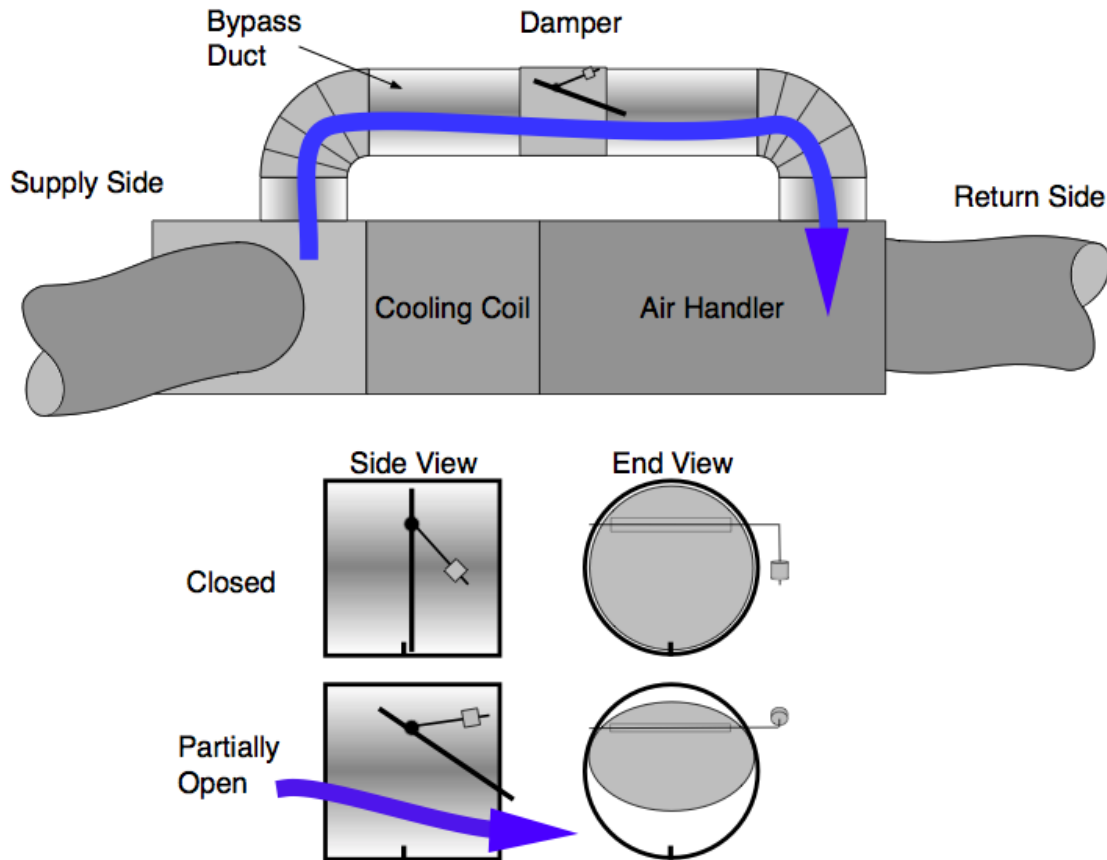

Credit: Russ King, P.E.

This diagram shows a common bypass duct/damper strategy. The bypass duct is sheet metal (which should always be insulated) and the damper is a barometric type. The details show how the damper opens when air pressure builds up against the adjustable weight. Sending heated or cooled air back into the space conditioning equipment can cause problems and reduce efficiency.

These photos show two examples of zonal control control-boards:

**Figure 6: Photo of a duct-mounted control board.**



Credit: Russ King, P.E.



**Figure 7: Photo of a cabinet-mounted control board.**



Credit: Russ King, P.E.

## F1.4 Identifying Multi-Speed/Variable-Speed Condensers

Most condensers operate at a single speed and capacity and either run for longer or shorter periods of time during hotter or cooler weather, respectively. Short run times (aka, short cycling) reduce efficiency. Multi-speed condensers typically have a high and low speed. This can be accomplished by two separate compressors inside a single condenser, or by a single dual-stage compressor. During cooler weather (aka, part load times) the condenser will run in low speed for longer run periods. When needed, the condenser can run in high speed.

Variable-speed condensers are not limited to just high and low speeds. They can gradually ramp from lowest to highest speeds as needed.

There are several features that can indicate that a condenser is multi-speed. These include:

1. Product tags, labels and marketing names that indicate two-stage, dual-stage, multi-stage, etc.
2. Two compressors observed by looking down through the condenser fan.
3. High and low capacities or nominal tonnages indicated on nameplate.

The definitive way to determine if the condenser is multi-speed or variable speed is to record the make and model number and find the manufacturer's specifications.

## F1.5 References:

JA1: Glossary

ZONAL CONTROL is the practice of dividing a residence into separately controlled HVAC zones. This may be done by installing multiple HVAC systems that condition a specific part of the building, or by installing one HVAC system with a specially designed distribution system that permits zonal control. The Energy Commission has approved an alternative calculation method for analyzing the energy impact of zonally controlled space heating and cooling systems. To qualify for compliance credit for zonal control, specific eligibility criteria specified in the Residential ACM Manual must be met.

§150.0(m)13C. **Zonally Controlled Central Forced Air Systems.** Zonally controlled central forced air cooling systems shall be capable of simultaneously delivering, in every zonal control mode, an airflow from the dwelling, through the air handler fan and delivered to the dwelling, of greater than 350 CFM per ton of nominal cooling capacity, and operating a gas furnace air-handling unit fan efficacy of less than or equal to 0.45 W/cfm or an air-handling unit that is not a gas furnace fan efficacy of less than or equal to 0.58 W/CFM as confirmed by field verification and diagnostic testing in accordance with the procedures specified in Reference Residential Appendix RA3.3.

**EXCEPTION 1 to 150.0(m)13C:** Multi-speed compressor systems or variable speed compressor systems shall demonstrate compliance for airflow (cfm/ton) and fan efficacy (Watt/cfm) by operating the system at maximum compressor capacity and maximum system fan speed and with all zones calling for conditioning.

**EXCEPTION 2 TO 150.0(M)13C:** Gas furnace air-handling units manufactured prior to

July 3, 2019 shall with a fan efficacy value less than or equal to 0.58 W/cfm.

§150.1(c)13. **HVAC System Bypass Ducts.** Unless otherwise specified on the Certificate of Compliance, bypass ducts that deliver conditioned supply air directly to the space conditioning system return duct airflow shall not be used. All zonally controlled forced air systems shall be verified by a HERS Rater utilizing the procedure in Reference Residential Appendix Section RA3.1.4.6 to confirm compliance with 150.1(c)13.

---

#### RA 3.1.4.6 Verification of Prescriptive Bypass Duct Requirements for Zonally Controlled Forced Air Systems

When a zonally controlled forced air system is installed, one the following shall be verified to determine compliance as required by Energy Standards §150.1(c)13:

1. A visual inspection shall confirm that bypass ducts that deliver conditioned supply air directly to the space conditioning system return duct airflow are not used.
2. If the Certificate of Compliance indicates an allowance for use of a bypass duct, the bypass duct shall conform to the specifications given on the Certificate of Compliance.

If the zonally controlled system meets one of these criteria, the system complies. Otherwise, the system does not comply.

---

---

# Appendix G

## Verification of the Existing Features of a Home for Existing + Addition + Alteration Performance Approach

When adding to or altering an existing home, compliance credit can be taken for upgrading existing features by using the performance approach when the existing features are verified by a qualified HERS rater prior to registration of the certificate of compliance (CF1R).

The performance approach provides a means to trade off against features that may not meet the prescriptive requirements, such as exceeding the allowed maximum glass area, by demonstrating that the project (proposed design) achieves the same level of efficiency as it would if it were built to the prescriptive requirements (standard design). The standard design is a hypothetical building with prescriptive requirements from Table 150.1-A that sets the target energy budget for the proposed project.

The Existing + Addition + Alteration approach gives further credit for upgrading existing features. It does this by modifying the standard design for an altered building feature to match the requirements specified in Section 150.2, particularly Table . The greater the efficiency of the altered building feature is relative to the existing energy efficiency, the greater the compliance credit will be. Third-party verification of the features prior to the construction is required to achieve the maximum compliance credit.

The proposed design is calculated using the actual energy efficiency values of the existing unaltered components of the existing building, and the proposed values of the altered components, plus the proposed addition's features. Each building component must be modeled with one of the following classifications to determine the standard design:

"Existing" – building components that remain unchanged (e.g., exterior walls in the existing portion of the building that will not be altered) but must be verified.

"Altered" –existing building components proposed to be changed (e.g., added roof insulation, or a furnace that is being replaced).

"New" – building components that do not exist prior to the construction work (e.g., new walls added to create the addition). This includes building components in a previously unconditioned space being converted to conditioned space.

All of these building components determine how the standard design is calculated. Existing features are modeled the same in both the proposed and standard designs. New features are modeled in the standard design according to prescriptive requirements in Table 150.1-A. Altered features are modeled in the standard design according to Table 150.2-D.

There are two columns in Table 150.2-D. One column defines how the standard design is calculated for altered components when the existing features are not verified by a HERS rater. The other column indicates how the standard design is calculated when the existing features are verified by a HERS rater prior to construction.

For the building to comply, the proposed design (proposed project details as modeled) must be equal to or less than the standard design. When a feature in the proposed design is better than the standard design, it receives a compliance credit that can be used to trade against less efficient features. For example, without third-party verification, windows to be altered are assumed to have 0.40 U-factor and 0.35 solar heat gain coefficient (SHGC). With HERS verification, if the existing windows are single pane metal framed, they are assumed to have 1.28 U-factor and 0.80 SHGC, resulting in substantial potential compliance credit if the new windows meet current prescriptive requirements of 0.30 U-factor and 0.23 SHGC.

Example:

Consider the house in Figure G-1 in climate zone 12. The shaded area is the addition. Some windows and walls are removed to build the addition. These are ignored. The existing home has the following features:

Single-pane metal framed windows

2x4 R-0 walls, and R-19 attic insulation

AFUE 75 furnace

**Figure G-1 – The Proposed Addition and Alterations**

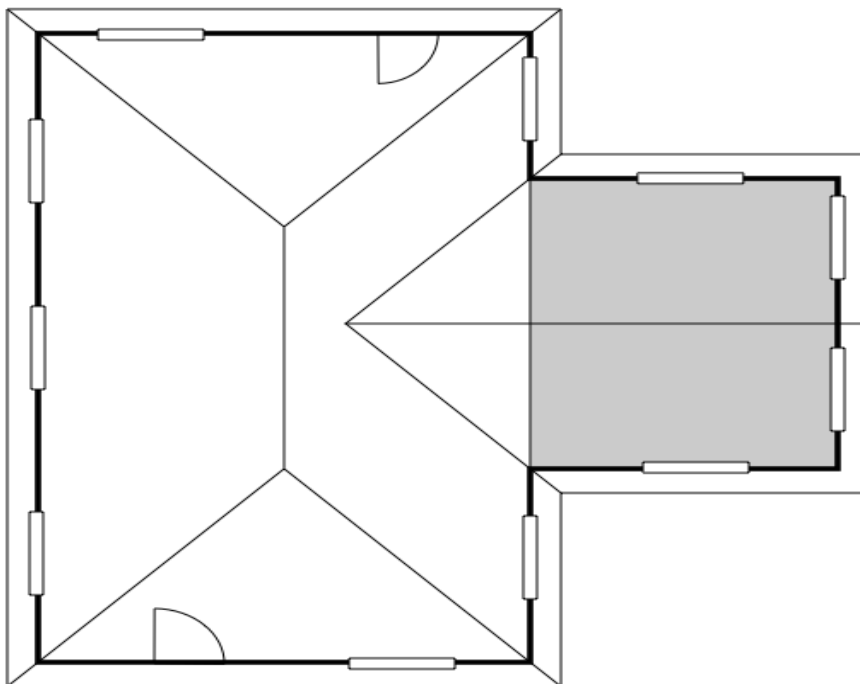

**Table G-1**

<b>Component</b>	<b>Status</b>	<b>Proposed</b>	<b>Standard Design w/o verification</b>	<b>Standard Design w/ verification</b>
Attic	Existing/Altered	NA	R-22	R-19
Attic <sup>i</sup>	New	R-38	n/a	n/a
Wall	Existing/Altered	n/a	R-13	R-0
Walls <sup>ii</sup>	New	R-15	n/a	n/a
Window	Existing/Altered U-factor; SHGC	n/a	0.40; 0.35	1.28; 0.80
Window	New	0.30; 0.23	n/a	n/a
Furnace	Existing/Altered/New	0.92 AFUE	0.80 (Federal Minimum)	0.75

Part of the construction work includes replacing all of the windows with low emissivity (low-E) vinyl windows to match the new windows in the addition, adding insulation to the existing attic and replacing the existing furnace.

For the proposed design, none of the attic is modeled as existing because insulation is being added to the existing building ("altered"), and the attic in the addition is "new." None of the windows are modeled as existing (unless any are not replaced). Replaced windows in the existing building are "altered" and the windows in the addition are "new." The furnace, even though it is new, is modeled as "altered" because it is replacing an existing heating system. The walls, windows, and other components that are removed as part of the addition and alterations are ignored.

Table G-1 illustrates how the proposed features and the standard design features are calculated, depending on whether there is HERS verification of the existing conditions.

The HERS Rater must complete the verification of the existing conditions in order to register the certificate of compliance (CF1R).

HERS Raters follow the protocols for a Whole-House Home Energy Rating (WHHER) when verifying existing conditions. The HERS Rater is trained by a HERS Provider to verify the existing conditions of the home consistent with Energy Commission approved HERS Provider training for the verification requirements specified in Table 150.2-D. The Data Registry will generate a CF3R-EXC-20-H compliance document based on the output from the performance compliance software. The CF3R-EXC-20-H will list the features of the existing conditions that must be field verified by the HERS Rater. A registered CF3R-EXC-20-H that agrees with the existing conditions input for the proposed building is required by the HERS Registry as a prerequisite the registration of the CF1R for the project.

The WHHER protocols are established by the HERS Technical Manual (CEC-400-2008-012). Appendix A of that document details the protocols for verification of each

component. HERS Raters must follow all Energy Commission approved procedures established by the HERS Provider. The [HERS Technical Manual](#) can be downloaded from:

<https://www.energy.ca.gov/publications/2019/hers-home-energy-rating-system-technical-manual>

For comparisons with approaches used during the 2016 Energy Code cycle and before, Table G-2 below was used to model existing conditions based on the year that a building was constructed. This table was superseded during the 2019 code cycle, and in the 2022 Energy Code, the table that supersedes Table G-2 is Table 150.2-D.

**Table G-2 – Standard Design for an Altered Component (2016 Code Cycle and Before)**

Conservation Measure	Before 1978	1978 to 1983	1984 to 1991	1992 to 1998	1999 to 2000	2001 to 2003	2004 to 2005	2006 to 2013	2014 to Present
Cool Roof Solar Reflectance	0.10	0.10	0.10	0.10	0.10	0.10	0.10	Table 150.1-A	Table 150.1-A
Radiant Barrier	None	None	None	None	None	None	Table 150.1-A	Table 150.1-A	Table 150.1-A
Roof/Ceiling U-factor	0.079	0.049	0.049	0.049	0.049	0.049	0.049	0.049	0.031
Wall U-factor	0.356	0.110	0.110	0.102	0.102	0.102	0.102	0.102	0.102
Raised Floor – Crawl Space U-factor	0.099	0.099	0.099	0.049	0.049	0.049	0.049	0.049	0.037
Raised Floor- No Crawl Space U-factor	0.238	0.238	0.238	0.064	0.064	0.064	0.064	0.064	0.049
Slab Edge F-factor	0.73	0.73	0.73	0.73	0.73	0.73	0.73	0.73	0.73
Duct R-value	R-2.1	R-2.1	R-2.1	R-4.2	R-4.2	R-4.2	R-4.2	Table 150.1-A	Table 150.1-A
Building Leakage (ACH50)	7.7	7.7	7.7	7.7	7.7	7.7	7.7	6.8	5.0
Duct Leakage (%)	15%	15%	15%	15%	15%	15%	15%	15%	6%

<b>Conservation Measure</b>	<b>Before 1978</b>	<b>1978 to 1983</b>	<b>1984 to 1991</b>	<b>1992 to 1998</b>	<b>1999 to 2000</b>	<b>2001 to 2003</b>	<b>2004 to 2005</b>	<b>2006 to 2013</b>	<b>2014 to Present</b>
Fenestration U-factor	Use Energy Standards Table 110.6-A, §110.6 for all vintages	Use Energy Standards Table 110.6-A, §110.6 for all vintages	Use Energy Standards Table 110.6-A, §110.6 for all vintages	Use Energy Standards Table 110.6-A, §110.6 for all vintages	Use Energy Standards Table 110.6-A, §110.6 for all vintages	Use Energy Standards Table 110.6-A, §110.6 for all vintages	Use Energy Standards Table 110.6-A, §110.6 for all vintages	Use Energy Standards Table 110.6-A, §110.6 for all vintages	Use Energy Standards Table 110.6-A, §110.6 for all vintages
Fenestration SHGC	Use Energy Standards Table 110.6-B, §110.6 for all vintages	Use Energy Standards Table 110.6-B, §110.6 for all vintages	Use Energy Standards Table 110.6-B, §110.6 for all vintages	Use Energy Standards Table 110.6-B, §110.6 for all vintages	Use Energy Standards Table 110.6-B, §110.6 for all vintages	Use Energy Standards Table 110.6-B, §110.6 for all vintages	Use Energy Standards Table 110.6-B, §110.6 for all vintages	Use Energy Standards Table 110.6-B, §110.6 for all vintages.	Use Energy Standards Table 110.6-B, §110.6 for all vintages.
Fenestration Shading Devices	Exterior: Assumed to have 50% bug screens, model actual overhangs	Exterior: Assumed to have 50% bug screens, model actual overhangs	Exterior: Assumed to have 50% bug screens, model actual overhangs	Exterior: Assumed to have 50% bug screens, model actual overhangs	Exterior: Assumed to have 50% bug screens, model actual overhangs	Exterior: Assumed to have 50% bug screens, model actual overhangs	Exterior: Assumed to have 50% bug screens, model actual overhangs	Exterior: Assumed to have 50% bug screens, model actual overhangs.	Exterior: Assumed to have 50% bug screens, model actual overhangs



<b>Conservation Measure</b>	<b>Before 1978</b>	<b>1978 to 1983</b>	<b>1984 to 1991</b>	<b>1992 to 1998</b>	<b>1999 to 2000</b>	<b>2001 to 2003</b>	<b>2004 to 2005</b>	<b>2006 to 2013</b>	<b>2014 to Present</b>
Space Heating Central Gas Furnace (AFUE)	0.75	0.78	0.78	0.78	0.78	0.78	0.78	0.78	0.78
Space Heating Gas Room Heater (AFUE)	0.65	0.65	0.65	0.65	0.65	0.65	0.65	0.65	0.65
Space Heating Hydronic/Comb Hydronic (TE)	0.78	0.78	0.78	0.78	0.78	0.78	0.78	0.78	0.78
Space Heating Heat Pump (HSPF)	5.6	5.6	6.6	6.6	6.8	6.8	6.8	7.4	7.7
Space Heating Electric Resistance (HSPF)	3.413	3.413	3.413	3.413	3.413	3.413	3.413	3.413	3.413
Electric Resistance Radiant (HSPF)	3.55	3.55	3.55	3.55	3.55	3.55	3.55	3.55	3.413
Space Cooling All Types (SEER)	8.0	8.0	8.9	9.7	9.7	9.7	9.7	13.0	13.0
Water Heating Energy Factor	0.525	0.525	0.525	0.525	0.575	0.575	0.575	0.575	0.575

## Appendix H - Demand Responsive Controls

This appendix to the residential compliance manual addresses the demand responsive (DR) control requirements in the 2022 Building Energy Efficiency Standards (Energy Standards).

Demand response is an increasingly important function of buildings as distributed energy resources become more common and customers have access to time of use electricity rates and incentive programs designed to encourage demand side optimization. Demand response occurs on a range of timescales, from seconds to seasons, and represents any demand change in response to grid or economic needs. In addition to current time of use electricity rates, utilities in the future will likely connect electricity costs to high frequency fluctuations in both the supply and demand for electricity. Appropriate demand responsive controls allow building operators to maintain the quality of services a building provides and reduce the total cost of energy by automating a building's response to changes in electricity rates.

The following definitions from §100.1 are relevant to the DR control requirements:

**Demand response** is short-term changes in electricity usage by end-use customers, from their normal consumption patterns. Demand response may be in response to:

- a. Changes in the price of electricity; or
- b. Participation in programs or services designed to modify electricity use.
  - i. In response to wholesale market prices.
  - ii. When system reliability is jeopardized.

**Demand response period** is a period of time during which electricity loads are modified in response to a demand response signal.

**Demand response signal** is a signal that indicates a price or a request to modify electricity consumption for a limited time period.

**Demand responsive control** is an automatic control that is capable of receiving and automatically responding to a demand response signal.

The DR control requirements ensure that the building is DR capable (i.e., capable of responding to a DR signal). The decision to employ demand response is up to the building owner or manager, in coordination with their utility company and/or a governing authority. A building that is capable of receiving and responding to a demand response signal is sufficient to meet the requirements of the Energy Standards. DR-capable is described as follows:

**DR-capable:** A building is capable of DR when the building has loads that can be curtailed, DR controls are installed, and the controls have been programmed/configured so the test control strategy that is defined in the building

code can be deployed (note: the DR controls can be programmed with additional control strategies).

**DR-enabled:** A building's DR is enabled when the connection between the entity that sends the DR Signal and the DR control in the building has been tested and communications have been allowed or "enabled".

**DR-enrolled:** A building is enrolled when the building owner/occupant has enrolled in a DR program (note: this may include updating the settings or programming of the DR controls to better match the terms of the program).

The requirements for DR controls only apply if the controls are used to comply with the building standards (i.e., DR thermostats or a heat pump water heater). If DR control are installed voluntarily and do not contribute to compliance with minimum code requirements, they do not need to adhere to requirements in Title 24, Part 6.

For residential dwellings, DR controls are only required as a part of specific Exceptions to HVAC and Solar Ready requirements.

---

## 1. Communications Requirements for DR Controls

### *§110.12(a)1-5*

There are two main communication requirements that apply to all DR controls:

1. The control must, at minimum, be able to understand a signal sent using OpenADR; and
2. The control must, at a minimum, be able to communicate with the virtual end node using a wired or wireless bi-directional communication pathway.

These are minimum requirements, meaning that the control can have (and use) additional communication features provided that the required features are included.

### 1.1 Communication With Entity That Initiates DR Signal

#### *§110.12(a)1*

DR controls must have the capability of communicating with the entity that initiates a DR signal by way of an OpenADR certified virtual end node (VEN).

The OpenADR 2.0 protocol is the primary open-standard protocol used in the California market. It implements a profile within the Organization of Structured Information Standards (OASIS) Energy Interoperation information and communication model that defines two types of communications entities – virtual top nodes (VTNs) and virtual end nodes (VENs). VTNs are information exchange servers typically operated by utilities or third-party providers and can dispatch events. VENs are the recipients of DR payloads and are typically the gateway or end-use devices installed at customer facilities

throughout a dispatcher’s territory. See [OpenADR Alliance’s website](http://www.openadr.org/) (<http://www.openadr.org/>) for more information about OpenADR certified VENs.<sup>1</sup>

There are two ways to comply with the OpenADR certified VEN requirement:

**Option A: Install an OpenADR 2.0a or 2.0b certified VEN within the building as part of the DR control system (§110.12(a)1A)**

If complying using Option A (§110.12(a)1A), the designer of the DR control system(s) must select a VEN that the OpenADR Alliance has certified as being compliant with the OpenADR 2.0a or 2.0b specification.<sup>2</sup> The OpenADR Alliance maintains a [list of certified VENs](https://products.openadr.org/) (<https://products.openadr.org/>). If using Option A, the certified VEN must be installed inside the building at the time of inspection. The building can comply if the DR control system has a certified VEN that is incorporated into a networked system of devices such that the single VEN communicates control strategy information to multiple devices in the network (e.g., a gateway system), or if each device (e.g., thermostat) in the building is itself a certified VEN.

**Option B: Install a DR control system that has been certified to the Energy Commission as being capable of communicating with an OpenADR 2.0b certified VEN (§110.12(a)1B)**

If complying using Option B (§110.12(a)1B), the designer of the DR control system(s) must select a DR control system that the Energy Commission has approved for the certified list of DR control systems. The Energy Commission maintains a [list of certified products and instructions on how manufacturers can certify products](http://www.energy.ca.gov/title24/equipment_cert/) on their website:

[http://www.energy.ca.gov/title24/equipment\\_cert/](http://www.energy.ca.gov/title24/equipment_cert/). If using Option B, the manufacturer of a DR control system must submit documentation to the Energy Commission confirming that the DR control system is capable of communicating with an OpenADR 2.0b certified VEN. Demand responsive controls must be programmed or configured so any test control strategy defined in building code can be deployed at the time of permitting.

Option B requires that the manufacturer of the DR control system certify to the Energy Commission that the control system is capable of communicating with an OpenADR 2.0b certified VEN. This requirement does not mean that the DR control system must be connected to a 2.0b certified VEN. When the DR control system is connected to a VEN, it can be connected to either a 2.0a or 2.0b certified VEN.

The DR control system must comply with Option A or Option B, but the control system can also include features that allow the control system to use other communications protocols.

---

1 The [OpenADR Alliance’s Frequently Asked Questions webpage](http://www.openadr.org/faq) is a helpful resource: <http://www.openadr.org/faq>.

2 The [OpenADR 2.0a and 2.0b specifications](http://www.openadr.org/specification) are available on the OpenADR Alliance’s website: <http://www.openadr.org/specification>.

When specifying DR control systems, it is recommended that the controls designer check to see which DR programs are currently available in the area and specify controls that are both compliant with Title 24, Part 6, and eligible for the area's DR programs.

---

## 2. Other Requirements for DR Controls

### 2.1 Perform Regular Functions When Not Responding to DR Events

#### §110.12(a)4

Controls that include demand response with other control functions must perform their regular control functions, as required by other parts of the building code, when the control is not performing DR-related functions. This includes when the controls are not responding to a DR event, when the DR functions are not enabled (see description of DR-enabled in the introduction to this chapter of the compliance manual) or when the DR controls are temporarily disabled or disconnected (e.g., due to a network outage).

For example, if the building owner/operator never enables the DR controls or enrolls in a DR program, the building control system(s) must comply with all other applicable controls requirements and continue to provide those control functions. Similarly, if the building owner/operator does enable the DR controls and is enrolled in a DR program, the building control system(s) must perform as required by the applicable building code requirements whenever the building is not participating in a DR event. The DR control functionality is an additional control feature on top of all of the other required building controls.

### 2.2 Certification Requirements for DR Thermostats

#### §110.12(a)5

Residential DR thermostats, also called Occupant Controlled Smart Thermostats (OCSTs), must comply with the technical specifications described in Joint Appendix 5 (JA5). According to the requirement in JA5, manufacturers of DR thermostats must submit documentation to the Energy Commission to certify that the thermostat meets the code requirements. See the Energy Commission's website for a [list of certified products and for instructions to manufacturers](http://www.energy.ca.gov/title24/equipment_cert/) that wish to certify products: [http://www.energy.ca.gov/title24/equipment\\_cert/](http://www.energy.ca.gov/title24/equipment_cert/).

---

## 3. Energy Management Control Systems and Home Automation Systems

Required thermostatic and lighting control functions (including DR control functions) can be incorporated into and performed by an energy management control system (EMCS). Using an EMCS to perform these control functions complies with Title 24 provided that all of the criteria that would apply to the control are met by the EMCS.

A home automation system that manages energy loads (such as HVAC and lighting systems) is considered a type of energy management control system and, as such, can similarly incorporate the ability to provide required control functions.